

Installation Manual 2N[®] IP Style

2N

Content:

- 1. Product Overview
 - 1.1 Components and Associated Products
 - 1.2 Terms and Symbols
- 2. Description and Installation
 - 2.1 Before You Start
 - 2.2 Mechanical Installation
 - 2.2.1 Chassis Installation
 - 2.2.2 Mounting Box Installation
 - 2.3 Electric Installation
 - 2.3.1 Overvoltage Protection
 - 2.4 Extending Module Connection
- 3. Function and Use
 - 3.1 Configuration
 - 3.1.1 2N® IP Style LAN Location via 2N® Network Scanner
 - 3.2 2N® IP Style User Control
 - 3.3 Intercom Control as Viewed by Internal User
 - 3.4 Maintenance
 - 3.5 Downloads
- 4. Technical Parameters
- 5. Supplementary Information
 - 5.1 Troubleshooting
 - 5.2 Directives, Laws and Regulations
 - 5.3 Other Countries Legislation
 - 5.4 General Instructions and Cautions

1. Product Overview

Here is what you can find in this section:

- [1.1 Components and Associated Products](#)
- [1.2 Terms and Symbols](#)

Basic Features

2N® IP Style – is an elegant and reliable intercom equipped with lots of useful functions. Thanks to SIP support and compatibility with major brands of PBX manufacturers, it can benefit from using VoIP networks. **2N® IP Style** can be used as a door or special-purpose intercom for office buildings, residential areas and other applications.

ARTPEC-7 – high performance microcontroller supplied by Axis.

Wide-angle HD camera – allows the called user to see the calling persons on the 2N answering units, videophone displays or PC screens. The intercom is equipped with night vision, which automatically selects the night/day mode according to light.

10" touch display – displays the list of destinations (groups/individuals) for outgoing call setups. You can set up to three phone numbers and call time profiles to each of the buttons to make the called subscriber accessible any time.

Keypad – touch numeric keypad allowing you to use the intercom as a code lock for lock switch activation or for making calls to a selected user phone/virtual number.

Card Reader – integrated card reader providing access control management using 125 kHz and 13.56 MHz (optionally secured) RFID cards. With the advanced features, functions other than the door lock can be RFID card controlled too.

Electric lock switch – this switch can be controlled using an RFID card reader, a numeric keypad, the 2N® Mobile Key application in your smartphone, a PC application or during a call from any phone. If necessary, more modules with required outputs can be added.

Robustness – **2N® IP Style** is designed as a robust, mechanically resistant intercom, which withstands any weather conditions without the need of additional accessories.

Audio quality – thanks to the integrated acoustic echo cancellation (AEC), full duplex communication provides bilateral audibility even when the callers are speaking at the same time.

Installation of 2N® IP Style – the option is to use surface installation using a chassis or flush mounting using a wall mounting box.

Configuration of 2N® IP Style – use a PC equipped with any Internet browser. Use **2N® Access Commander** to configure extensive installations of multiple intercoms.

Advantages of Use:

- Elegant design
- 10" touch display
- Weather resistance
- Surface/flush mounting
- Sensitive microphone and Speakerphone
- Bidirectional communication – acoustic echo cancellation
- Integrated color HD camera with a wide-angle lens and night vision
- Touch numeric keypad
- Integrated electric lock switches with wide setting options
- Integrated 125 kHz and 13.56 MHz (optionally secured) RFID card reader
- LAN (PoE+) or external 12 V / 4 A power supply
- Configuration via device web interface
- SIP 2.0 and SIPS support
- Up to 10 000 phone book positions
- Up to 20 user time profiles
- Video codecs (H.264, MJPEG)
- Audio codecs (G.711, G.729, G.722, L16/16 kHz)
- HTTP server for configuration
- SNTP client for server time synchronization
- RTSP server for video streaming
- SMTP client for email sending
- TFTP/HTTP client for automated configuration and firmware update

1.1 Components and Associated Products

Main Units	
<p>2N Part No. 9157101P</p> 	<p>2N IP Style</p> <ul style="list-style-type: none"> • Main unit with protective glass • Internal 125 kHz and 13.56 MHz card reader

Main Units

2N Part No. 9157101P-S



2N IP Style

- Main unit with protective glass
- Internal 125 kHz and secured 13.56 MHz card reader

2N Part No. 9157101
Axis Part No. 02521-001



2N IP Style

- Main Unit
- Internal 125 kHz and 13.56 MHz card reader

Main Units

Part No. 9157101-S
Axis Part No. 02407-001



2N IP Style

- Main Unit
- Internal 125 kHz and secured 13.56 MHz card reader

Screen protection

Part No. 9157003



- protective glass for **2N IP Style** touch screen
- with active hygienic protection
- hardened glass with 9H rating and IK08 resistance

Mounting Accessories

Part No. 9157002
Axis Part No. 02406-001





- **2N IP Style** surface mounting chassis



Mounting Accessories

Part No. 9157001
Axis Part No. 02405-001



- **2N IP Style** flush mounting box

Extending Modules	
<p>2N Part No. 91550941</p> 	<ul style="list-style-type: none"> • 2N IP Verso – RFID Reader, 125 kHz • The card reader module provides you with access control via contactless cards or keyfobs. The module supports the 125 kHz EM4xxx cards.
<p>2N Part No. 91550941US</p> <p>Axis Part No. 02140-001</p> 	<ul style="list-style-type: none"> • 2N IP Verso – RFID Reader, 125 kHz • The card reader module provides you with access control via contactless cards or keyfobs. The module supports the 125 kHz EM4xxx cards.
<p>2N Part No. 91550942</p> <p>Axis Part No. 02139-001</p> 	<ul style="list-style-type: none"> • 2N IP Verso – RFID Reader NFC/HCE support, 13.56 MHz • The card reader module provides you with access control via contactless cards or keyfobs. The module supports the following 13.56 MHz cards or other carriers (only card serial number is read): <ul style="list-style-type: none"> • ISO14443A (MIFARE DESFire) • PicoPass (HID iClass) • FeliCa • ST SR(IX) • 2N Mobile Key

Extending Modules	
<p>2N Part No. 91550942-S</p> <p>Axis Part No. 02141-001</p> 	<ul style="list-style-type: none"> • 2N IP Verso – Secured RFID Card Reader NFC/HCE support, 13.56 MHz • The card reader module provides you with access control via contactless cards or keyfobs. The module supports the following 13.56 MHz cards or other carriers (only card serial number is read): <ul style="list-style-type: none"> • ISO14443A (MIFARE DESFire) • PicoPass (HID iClass) • FeliCa • ST SR(IX) • 2N Mobile Key • HID SE (Seos, iClass SE, MIFARE SE)
<p>2N Part No. 9155045</p> <p>Axis Part No. 01276-001</p> 	<ul style="list-style-type: none"> • 2N IP Verso – Fingerprint reader • The Fingerprint reader is used for verification of human fingers for access control and intercom control.
<p>2N Part No. 9155041</p> <p>Axis Part No. 01263-001</p> 	<ul style="list-style-type: none"> • 2N IP Verso – Induction loop • The induction loop module is used to transmit an audio signal directly into a hearing aid via a magnetic field.

Extending Modules	
<p>Part No. 9155037</p> <p>Axis Part No. 01259-001</p> 	<ul style="list-style-type: none"> • 2N IP Verso – Wiegand • The module helps you interconnect your system with other systems via the Wiegand interface. The module is installed under another module, i.e. needs no separate position.
<p>Part No. 91550371</p> <p>Axis Part No. 02577-001</p> 	<ul style="list-style-type: none"> • 2N IP Verso – OSDP module • The OSDP module provides communication between a connected device (control panel, door controller) and 2N IP Verso via the OSDP. The module is installed under another module, i.e. needs no separate position.

Extending Modules

**2N Part No.
9155034**

**Axis Part No.
01257-001**





- **2N IP Verso** – I/O
- The module provides logical inputs and outputs for sensor integration. The module is installed under another module, i.e. needs no separate position.
- Inputs and outputs
 - RELAY1 – RELAY1 terminals with accessible 30 V / 1 A AC/DC NO/NC contact
 - RELAY2 – RELAY2 terminals with accessible 30 V / 1 A AC/DC NO/NC contact
 - IN1 – IN1 terminals for input in passive/ active mode (–30 V to +30 V DC)
 - OFF = open OR $U_{IN} > 1.5\text{ V}$
 - ON = closed contact OR $U_{IN} < 1.5\text{ V}$
 - IN2 – IN2 terminals for input in passive/active mode (–30 V to +30 V DC)
 - OFF = open OR $U_{IN} > 1.5\text{ V}$
 - ON = closed contact OR $U_{IN} < 1.5\text{ V}$
 - TAMPER – Tamper switch (9155038) input

**2N Part
No. 9155038**

**Axis Part No.
01260-001**



- **2N IP Verso** – Tamper switch
- The module secures your system against tampering by detecting intercom opening or top frame removing. The module is installed on a special place and needs no separate position.
- Remember to purchase an I/O module, Part No. 9155034, together with the tamper switch.

Extending Modules	
<p>Part No. 9137422E</p> 	<p>2N IP - External Bluetooth reader (USB interface)</p> <ul style="list-style-type: none"> • An external Bluetooth reader connected via USB to your computer. • It can be used for pairing new users who want to use their smartphones with the 2N Mobile Key application for access to controlled areas. • A USB driver is required for the external reader to work properly.
<p>Part No. 9155050</p> 	<ul style="list-style-type: none"> • 1 m interconnecting cable • Only one interconnecting cable is allowed in a single installation. • The maximum bus length is 7 m.
<p>Part No. 9155054</p> 	<ul style="list-style-type: none"> • 3 m interconnecting cable • Only one interconnecting cable is allowed in a single installation. • The maximum bus length is 7 m.

Extending Modules

Part No. 9155055



- 5 m interconnecting cable
- Only one interconnecting cable is allowed in a single installation.
- The maximum bus length is 7 m.

2N Indoor Units and Accessories

Part No. 91378601



- **2N Indoor View** – black
- Indoor answering audio/video unit with a touchscreen designed for all **2N IP intercoms**

Part No. 91378601WH



- **2N Indoor View** – white
- Indoor answering audio/video unit with a touchscreen designed for all **2N IP intercoms**

Part No. 91378501



- **2N Indoor Compact** – black
- Indoor answering audio/video unit with a touchscreen designed for all **2N IP intercoms**

Part No. 91378501WH



- **2N Indoor Compact** – white
- Indoor answering audio/video unit with a touchscreen designed for all **2N IP intercoms**

Part No. 91378401



- **2N Indoor Talk** – black
- Indoor answering audio unit with a touchscreen designed for all **2N IP intercoms**

Part No. 91378401WH



- **2N Indoor Talk** – white
- Indoor answering audio unit with a touchscreen designed for all **2N IP intercoms**

Part No. 91378800



- Wall/plasterboard flush mounting box for 2N indoor answering units.

Part No. 91378803



- Wall surface mounting box for 2N answering units.

Part No. 91378802



- Stand for 2N indoor answering units.

Part Numbers:

91378375

91378376



- **2N Indoor Touch 2.0** – black
- WiFi version (second Part No.)
- **2N Indoor Touch 2.0**, an elegant indoor touch panel, is designed for all **2N IP intercoms**. The display panel shows you the person standing at your door and helps you make conversation with the visitor, open the door lock or switch on the entrance hall lights.

Part Number:
91378382



- **2N Indoor Touch** – desk stand black

Part Numbers:
91378375WH
91378376WH





- **2N Indoor Touch 2.0** – white
- WiFi version (second Part No.)
- **2N Indoor Touch 2.0**, an elegant indoor touch panel, is designed for all of the **2N IP intercoms**. The display panel shows you the person standing at your door and helps you make conversation with the visitor, open the door lock or switch on the entrance hall lights.



Part Number:
91378382W



- **2N Indoor Touch** – Desk stand white

<p>Part Nos.: 91378381E 91378381GB 91378381US</p> 	<ul style="list-style-type: none"> • The exclusive type of power adapter SYS1561-0912 to be used with all 2N Indoor Touch 2.0 devices. • Stabilised 12 V / 0,75 A source to be used where PoE supply is unavailable. • The part numbers differ in their electric socket markings (E/GB/US).
<p>2N Part No. Axis Part No. 1120101W 02518-001</p> 	<ul style="list-style-type: none"> • 2N IP Handset • answering unit • white color
<p>2N Part No. Axis Part No. 1120101B 02519-001</p> 	<ul style="list-style-type: none"> • 2N IP Handset • answering unit • black color

IP Phones

<p>2N Part No. 1120102 Axis Part No. 02660-001</p> 	<ul style="list-style-type: none"> • 2N IP Phone D7A • simple operation • HD quality video calls • A display-equipped extender EXP50 (Part No. 91378363) can be added to the phone delivery to make up to 60 speed dialings.
<p>2N Part No. 1120111EU Axis Part No. 02544-001</p> 	<ul style="list-style-type: none"> • Grandstream GXV3350 IP video phone • Android 7.0 OS • 5” touch display control • HD quality video calls • WiFi and Bluetooth support • HDMI output and pan tilt zoom camera • Easy integration with intercoms or PBXs via SIP

Electric Locks



 • These products have been removed from sale.



<p>Part No. 11202101</p> 	<ul style="list-style-type: none"> • Mini electronic doorstrike series 5 • electric opener designed for door frame installation • intended for such narrow profiles as aluminum, wood or PVC in particular • short sheet metal front cover version (130 mm) • 16 mm width
<p>Part No. 11202101-L</p> 	<ul style="list-style-type: none"> • Mini electronic doorstrike series 5 - long • electric opener designed for door frame installation • intended for such narrow profiles as aluminum, wood or PVC in particular • long sheet metal front cover version (250 mm) • 16 mm width
<p>Part No. 11202102</p> 	<ul style="list-style-type: none"> • Mini electronic doorstrike series 5 - with momentum pin • electric opener designed for door frame installation • intended for such narrow profiles as aluminum, wood or PVC in particular • short sheet metal front cover version (130 mm) • 16 mm width



<p>Part No. 11202102-L</p> 	<ul style="list-style-type: none"> • Mini electronic doorstrike series 5 – with momentum pin, long • electric opener designed for door frame installation • intended for such narrow profiles as aluminum, wood or PVC in particular • long sheet metal front cover version (250 mm) • 16 mm width
<p>Part No. 11202103</p> 	<ul style="list-style-type: none"> • Mini electronic doorstrike series 5 – with mechanical blocking • electric opener designed for door frame installation • intended for such narrow profiles as aluminum, wood or PVC in particular • short sheet metal front cover version (130 mm) • 16 mm width
<p>Part No. 11202103-L</p> 	<ul style="list-style-type: none"> • Mini electronic doorstrike series 5 – with mechanical blocking, long • electric opener designed for door frame installation • intended for such narrow profiles as aluminum, wood or PVC in particular • long sheet metal front cover version (250 mm) • 16 mm width

<p>Part No. 11202104</p> 	<ul style="list-style-type: none"> • Mini electronic doorstrike series 5 – door signaling • electric opener designed for door frame installation • intended for such narrow profiles as aluminum, wood or PVC in particular • including a door state monitoring micro switch: open/closed • short sheet metal front cover version (130 mm) • 16 mm width
<p>Part No. 11202104-L</p> 	<ul style="list-style-type: none"> • Mini electronic doorstrike series 5 – door signaling, long • electric opener designed for door frame installation • intended for such narrow profiles as aluminum, wood or PVC in particular • including a door state monitoring micro switch: open/closed • long sheet metal front cover version (250 mm) • 16 mm width
<p>Part No. 11202105</p> 	<ul style="list-style-type: none"> • Mini electronic doorstrike series 5 – fail-safe • electric opener designed for door frame installation • intended for such narrow profiles as aluminum, wood or PVC in particular • under voltage: opener secured, blocked • at voltage interruption: opener unblocked, door can be opened • short sheet metal front cover version (130 mm) • 16 mm width

<p>Part No. 11202105-L</p> 	<ul style="list-style-type: none"> • Mini electronic doorstrike series 5 – fail-safe, long • electric opener designed for door frame installation • intended for such narrow profiles as aluminum, wood or PVC in particular • under voltage: opener secured, blocked • at voltage interruption: opener unblocked, door can be opened • long sheet metal front cover version (250 mm) • 16 mm width
<p>Part No. 11202106</p> 	<ul style="list-style-type: none"> • Mini electronic doorstrike series 5 – fail-safe and door signaling • electric opener designed for door frame installation • intended for such narrow profiles as aluminum, wood or PVC in particular • under voltage: opener secured, blocked • at voltage interruption: opener unblocked, door can be opened • short sheet metal front cover version (130 mm) • 16 mm width
<p>Part No. 11202106-L</p> 	<ul style="list-style-type: none"> • Mini electronic doorstrike series 5 – fail-safe and door signaling, long • electric opener designed for door frame installation • intended for such narrow profiles as aluminum, wood or PVC in particular • under voltage: opener secured, blocked • at voltage interruption: opener unblocked, door can be opened • long sheet metal front cover version (250 mm) • 16 mm width

<p>Part No. 11202201</p> 	<ul style="list-style-type: none"> • Electromechanical lock SAM 7255 • 72/55 self-locking lock with panic function • A key is necessary for door opening from the outside (or an electric pulse from a connected 2N IP intercom / reader). • convenient solution for emergency exits
<p>Part No. 11202201-M</p> 	<ul style="list-style-type: none"> • Electromechanical lock SAM 7255 with monitoring • 72/55 self-locking lock with panic function • A key is necessary for door opening from the outside (or an electric pulse from a connected 2N IP intercom / reader). • convenient solution for emergency exits
<p>Part No. 11202202</p> 	<ul style="list-style-type: none"> • Electromechanical lock SAM 9235 • 92/35 self-locking lock with panic function • A key is necessary for door opening from the outside (or an electric pulse from a connected 2N IP intercom / reader). • convenient solution for emergency exits

<p>Part No. 11202202-M</p> 	<ul style="list-style-type: none"> • Electromechanical lock SAM 9235 with monitoring • 92/35 self-locking lock with panic function • A key is necessary for door opening from the outside (or an electric pulse from a connected 2N IP intercom / reader). • convenient solution for emergency exits
<p>Part No. 11202301</p> 	<ul style="list-style-type: none"> • Cable protector FX290 • Provides secure passage and protection of the supply cable between the door frame and the door leaf. • 290 mm length
<p>Part No. 11202302</p> 	<ul style="list-style-type: none"> • Cable protector FX510 • Provides secure passage and protection of the supply cable between the door frame and the door leaf. • 510 mm length

<p>Part No. 11202303</p> 	<ul style="list-style-type: none"> • Cable protector FX300G • Provides secure passage and protection of the supply cable between the door frame and the door leaf. • 440 mm length
<p>Part No. 11202304</p> 	<ul style="list-style-type: none"> • Cable protector FX500G • Provides secure passage and protection of the supply cable between the door frame and the door leaf. • 640 mm length
<p>Part No. 11202203</p>	<ul style="list-style-type: none"> • Supply cable with 14-core connector • 6000 mm length • Conductor cross section: 14 × 0.22 mm • Terminated with a connector on one side • Designed for 11202201-M and 11202202-M locks
<p>Part No. 11202107</p> 	<ul style="list-style-type: none"> • Maglock MEX100 • used as a door holding supplement, not replacing the lock • consists of two parts: supplied part and counterpart • under voltage: door cannot be opened • at voltage interruption: magnets get disconnected, door opens

Part No. 11202501



- **Magnetic handle P300RP**
- fully replaces a mortise lock and handle
- under voltage: door cannot be opened
- at voltage interruption: magnets get disconnected, door opens
- suitable for wooden, metal and glass doors

Part No. 11202401





- **ED100**
- low energy simple door operator
- contactless operation
- can be interconnected with a motion sensor and electronic access control system
- applicable for right / left doors
- in / out opening versions

✓ **Tip**

- FAQ: [Electric locks – Difference between locks in 2N IP intercoms accesories](#)



Power Supply



<p>Part No. 91378101</p>  <p>A black rectangular PoE injector with two RJ45 ports labeled 'PoE' and 'LAN', and a 'Power' input on the top surface. The 'tenda' logo is visible on the top.</p>	<ul style="list-style-type: none"> • PoE+ injector • For intercom supply via the Ethernet cable where the PoE+ switch is absent.
<p>Part No. 932928</p>  <p>A small, light-colored transformer with two sets of screw terminals on the top and two sets on the bottom.</p>	<ul style="list-style-type: none"> • 12 V transformer • For 230 V mains voltage. • For external power supply of the lock with 12 V AC voltage.



Two-Wire Connection

<p>Part No. 9159014EU/US/UK</p>  <p>A silver metal converter with an 'EU' logo, a '2N 2WIRE' label, and an RJ45 port on the front. It has a mounting tab on the bottom.</p>	<ul style="list-style-type: none"> • 2N 2Wire • (set of 2 adapters plus EU/US/UK power supply) • The 2N 2Wire converter allows you to use the existing two-wire cabling from your original door bell or door intercom and connect any IP device to it. You do not have to configure anything, all you need is one 2N 2Wire unit at each end of the cable and a power supply connected to them.
---	--

13 MHz RFID

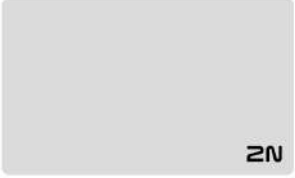

<p>Part No. 9159031</p> 	<ul style="list-style-type: none"> • External 13.56 MHz RFID card reader, Wiegand • Secondary reader for connection to an internal reader. It provides card access control from both sides of the door. IP68 cover, also suitable for exteriors. Card types: <ul style="list-style-type: none"> • ISO14443A (MIFARE DESFire) • PicoPass (HID iClass) • FeliCa • ST SR(IX) • 2N Mobile Key
<p>Part No. 9137421E</p> 	<ul style="list-style-type: none"> • 13.56 MHz, 125 kHz NFC/HCE USB RFID card reader • External RFID card reader connectable to a PC via a USB interface. Suitable for system administration and adding of 13.56 MHz, 125 kHz cards and Android platform devices supporting NFC/HCE using the 2N IP intercom web interface or 2N Access Commander. Suitable for MIFARE DESFire card upload to the 2N PICard Commander encryption application. The same card/device types are read as in the 2N IP intercom card readers: <ul style="list-style-type: none"> • 125 kHz <ul style="list-style-type: none"> • EM4xxx • 13.56 MHz <ul style="list-style-type: none"> • ISO14443A (MIFARE DESFire) • PicoPass (HID iClass) • FeliCa • ST SR(IX) • 2N Mobile Key

<p>Part No. 9137424E</p> 	<ul style="list-style-type: none"> • Secured 13.56 MHz, 125 kHz NFC/HCE USB RFID card reader • External secured RFID card reader connectable to a PC via a USB interface. Suitable for system administration and adding of 13.56 MHz, 125 kHz cards and Android platform devices supporting NFC/HCE using 2N IP intercom web interface or the 2N Access Commander application. Suitable for MIFARE DESFire card upload to the 2N PICard Commander encryption application. The same card/device types are read as in the 2N IP intercom card readers: <ul style="list-style-type: none"> • 125 kHz <ul style="list-style-type: none"> • EM4xxx • 13.56 MHz <ul style="list-style-type: none"> • ISO14443A (MIFARE DESFire) • PicoPass (HID iClass) • FeliCa • ST SR(IX) • 2N Mobile Key • HID SE (Seos, iClass SE, MIFARE SE)
<p>Part No. 9134173</p> 	<p>MIFARE Classic 1k RFID card, 13.56 MHz</p>
<p>Part No. 9134174</p> 	<p>MIFARE Classic 1k RFID fob, 13.56 MHz</p>

<p>Part No. 11202601</p> 	<ul style="list-style-type: none"> • 2N RFID card Mifare Desfire EV3 4K 13.56MH 10 pcs • 10 pcs per package • MIFARE DESFire EV3 (ISO/IEC14443A) • Suitable for data encryption in 2N PICard Commander
<p>Part No. 11202602</p> 	<ul style="list-style-type: none"> • 2N RFID fob Mifare Desfire EV3 4K 13.56MHz 10 pcs • 10 pcs per package • MIFARE DESFire EV3 (ISO/IEC14443A) • Suitable for data encryption in 2N PICard Commander

125 kHz RFID



<p>Part No. 9159030</p> 	<p>External 125 MHz RFID card reader, Wiegand</p> <p>Secondary reader for connection to an internal reader. It provides card access control from both sides of the door. IP68 cover, also suitable for exteriors. Reads EM4xxx cards.</p>
--	---

<p>Part No. 9137420E</p> 	<p>125 kHz USB RFID card reader</p> <p>External RFID card reader connectable to a PC via a USB interface. Suitable for system administration and adding of EM4xxx cards using 2N Access Commander.</p>
<p>Part No. 9134165E</p> 	<p>RFID card, type EM4100, 125 kHz</p>
<p>Part No. 9134166E</p> 	<p>Key fob RFID, type EM4100, 125 kHz</p>

Biometry

<p>Part No. 9137423E</p> 	<p>2N IP intercom- external fingerprint reader (USB interface)</p> <ul style="list-style-type: none"> Used for scanning user fingerprints into the device system in case an extending fingerprint reader module is connected to 2N IP Style.
---	---

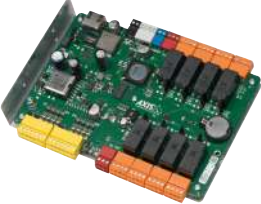

External Switches

<p>Part No. 9159010</p> 	<p>2N Security Relay</p> <p>A handy add-on that significantly enhances security Prevents lock tampering. Installed between the intercom, from which it is also supplied, and the lock to be controlled.</p>
<p>Part No. 9137410E</p> 	<p>External IP relay – 1 output</p> <p>A stand-alone IP device, which can be controlled from an IP intercom via HTTP commands. Helps control devices from an unlimited distance.</p>

<p>Part No. 9137411E</p> 	<p>External IP relay – 4 outputs, PoE</p> <p>A stand-alone IP device, which can be controlled from an IP intercom via HTTP commands. Helps control devices from an unlimited distance.</p>
<p>Part No. 9160501</p> 	<p>AXIS A9188 Network I/O relay module</p> <p>Lift control relay module for up to 8 floors</p>

Sensors and Switches

<p>Part No. 9159013</p> 	<p>Departure button</p> <p>Connects the logic input for door unlocking from inside the building.</p>
--	---

<p>Part No. 9154004</p> 	<p>Water-proof metal button (suitable for the internal RFID card reader)</p>
<p>Part No. 9159012</p> 	<p>Magnetic door contact A door installation set for door opening status identification. Used where the intercom is used for door protection to detect whether the door is not closed or forced open.</p>

Device Protection

<p>Part No. 9159011</p> 	<p>Wiegand Isolator The 2N Wiegand isolator is designed for galvanic isolation of two separately supplied devices interconnected via a Wiegand bus. The 2N Wiegand isolator protects the interconnected devices against communication errors and/or damage.</p>
--	---

License

<p>Part No. 9137909</p>	<ul style="list-style-type: none"> • Gold • Includes Enhanced Video, Enhanced Integration and Lift Control licenses
<p>Part No. 9137910</p>	<p>InformaCast</p>

 **Tip**

- Refer to the Configuration Manual for 2N IP Intercoms, Subs. [3.2 Function Licensing](#) for details.

 **Tip**

- Please refer to the local 2N distributor for more accessories and recommendations.

1.2 Terms and Symbols

The following symbols and pictograms are used in the manual:

Safety

- **Always abide** by this information to prevent persons from injury.

Warning

- **Always abide** by this information to prevent damage to the device.

Caution

- **Important information** for system functionality.

Tip

- **Useful information** for quick and efficient functionality.

Note

- Routines or advice for efficient use of the device.

2. Description and Installation

Here is what you can find in this section:

- [2.1 Before You Start](#)
- [2.2 Mechanical Installation](#)
- [2.3 Electric Installation](#)
- [2.4 Extending Module Connection](#)

2.1 Before You Start

Product Completeness Check

Before you start the installation, check whether the contents of your **2N® IP Style** package complies with the following list:

- 1x **2N® IP Style**
- 1x Brief Manual
- 1x Certificate of Ownership

2.2 Mechanical Installation

2N® IP Style is designed for surface or flush mounting. Additional accessories are required for each type of installation, which are not part of the main unit package.

The recommended height is 100–150 cm for standard installations and 100–120 cm for disabled persons from the floor to the device camera level. The installation height may vary depending on the device use.

- [2.2.1 Chassis Installation](#)
- [2.2.2 Mounting Box Installation](#)

2N® IP Style Main Unit Installation

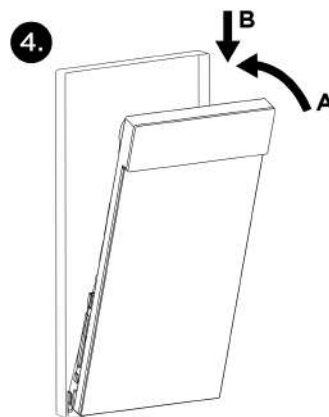
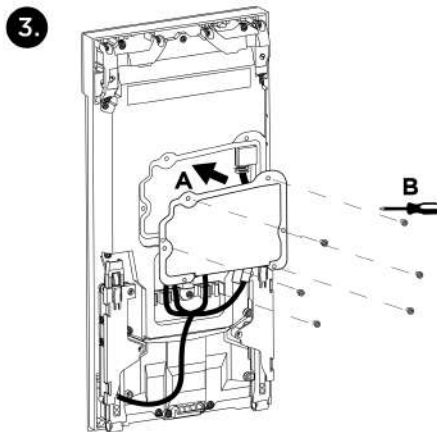
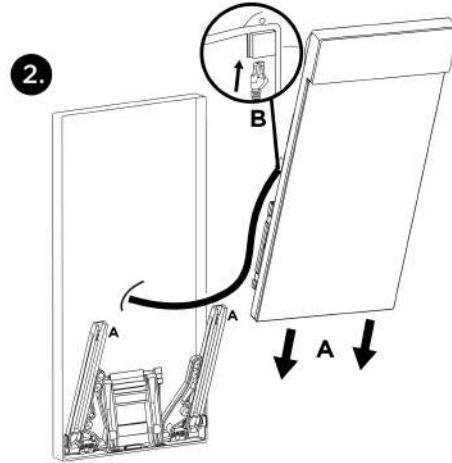
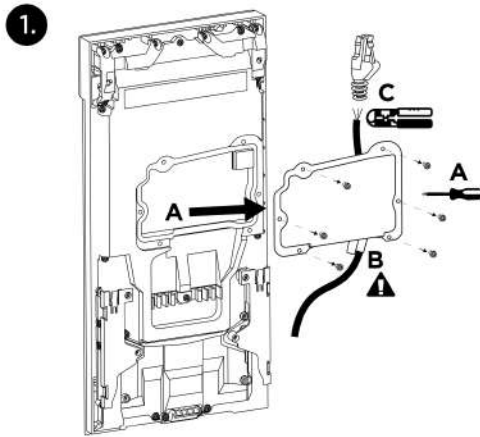

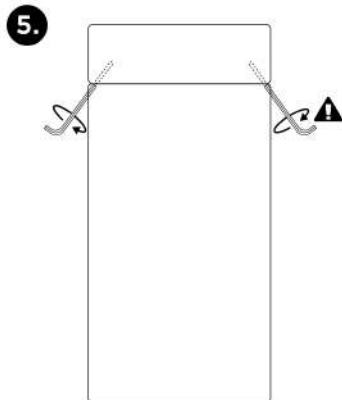

It is assumed that the chassis ([2.2.1 Chassis Installation](#)) or the flush mounting box ([2.2.2 Mounting Box Installation](#)) and all of the required cables have been installed. The recommended length of the accessible cables is 35 cm.

Unscrew the connector cover on the back of the device. Thread all of the unterminated cables (i.e. without terminals, end pieces, etc.) through the bushing on the inside of the connector cover. After threading the cables through the bushing, fit the required end pieces (1).

Fold out the mounting bracket located at the bottom of the chassis or flush mounting box. Fit the profiles on the device back onto the mounting bracket and slide them down to the lowest possible position, anchoring the device by snapping it into place (2A).

Connect all the cables to the device (2B). The mounting bracket provides sufficient support for cable installation and so it is unnecessary to support the device in any way.

After connecting and securing the superfluous cabling in the clips (3A), screw the connector cover back on (3B), fold in the device towards the chassis or the flush mounting box (4A) and then press downwards (4B) to seal the installation.

Now all you have to do is lock the position by tightening the two screws inside the device using an Allen key (5).

General Mounting Principles

✓ Tip

- Select flush mounting where possible. This makes the product elegant looking, more vandal resistant and more secure.
- You are advised to purchase the flush mounting boxes and chassis in advance and commission a building company to do the masonry for you, for example.

 **Caution**

- Before starting the mechanical installation on a selected place, make sure carefully that the preparations associated with it (drilling, wall cutting) cannot damage the electrical, gas, water and other existing wires and pipes.
- The warranty does not apply to the product defects and failures arisen as a result of improper mounting (in contradiction herewith). The manufacturer is neither liable for damage caused by theft within an area that is accessible after the attached electric lock is switched on. The product is not designed as a burglar protection device except when used in combination with a standard lock, which has the security function.
- When the proper mounting instructions are not met, water might get in and destroy the electronics. The intercom circuits are constantly under voltage and water infiltration causes an electro-chemical reaction. The manufacturer's warranty shall be void for products damaged in this way!

 **Caution**

- Make sure that the diameters of the dowel holes are accurate. If the diameters are too large, the dowels may get loose. Use the mounting glue to secure the dowels if necessary.
- Make sure that the depths of the dowel holes are accurate!
- Do not use low-quality dowels to avoid their falling out of the wall!
- Surface mounting always poses a problem where the installation is exposed to potential vandalism (such as public garages, etc.). In this case, use steel anchoring elements instead of the dowels and screws included in the delivery.
- Make sure that the mounting surface is flat with a maximum inequality of 0.5 mm. (e.g. prefabricated boards, glass, cut stone, etc.). If this is not the case, level the wall surface.
- Any intentional mechanical damage to the device (drilling, main unit tampering, etc.) results in a loss of warranty.

 **Warning**

- We do not recommend that **2N® IP Style** be installed on sites exposed to long-time direct sunlight to avoid overheating.
- Once overheated, the device is switched off and will be switched on automatically after it gets colder.

2.2.1 Chassis Installation

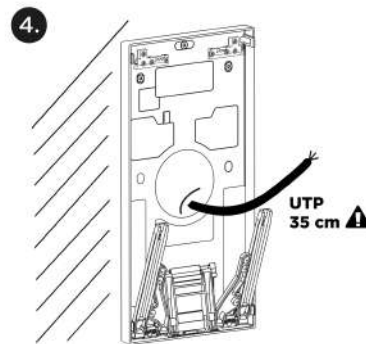
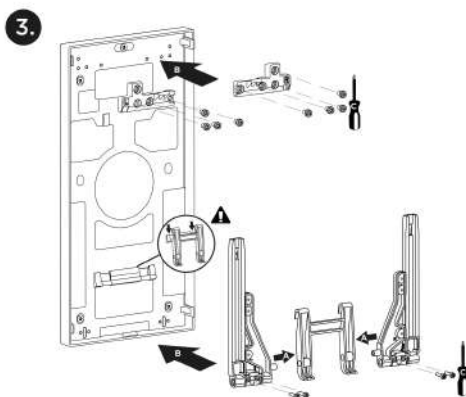
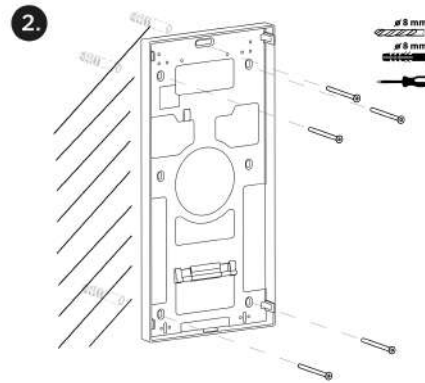
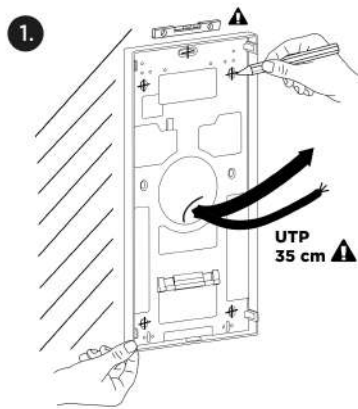

Drill chassis anchoring holes on a proper place. Use the chassis itself as a template to maintain the horizontal level and carry the cabling at the bottom edge of the cable hole. The recommended length of the accessible cables is 35 cm (1).

Insert the dowels in the holes drilled and use the screws to anchor the chassis (2).

Put the brackets to the left and right sides of the support handle and fit their positions using screws (3A).

Fit the lock counterparts to the upper chassis part, hang the handle with the brackets to the bottom part (4B) and fit all the components using screws (3C).

Now the chassis installation is complete (4).

 **Download**

[Drilling Template](#)

2.2.2 Mounting Box Installation

Mounting Box Installation

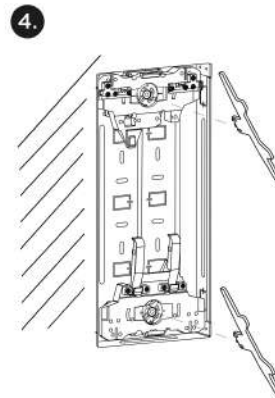
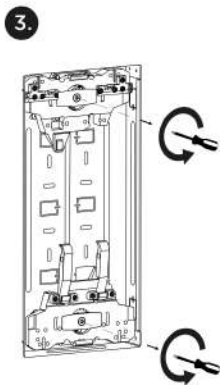
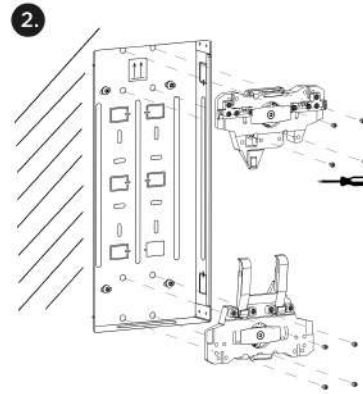
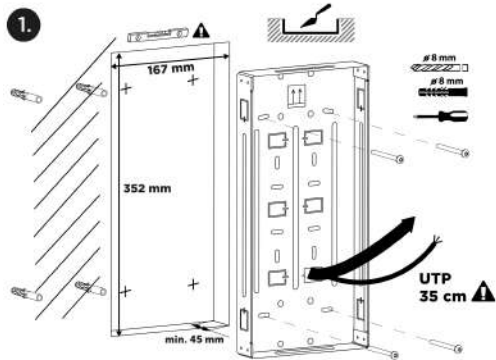

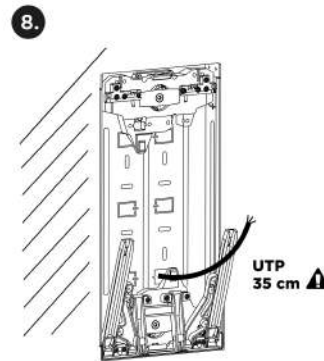
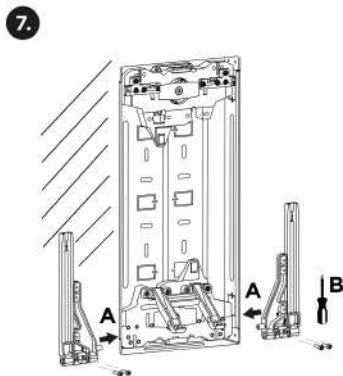
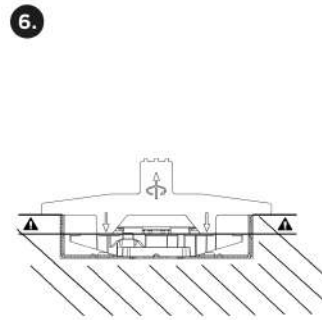
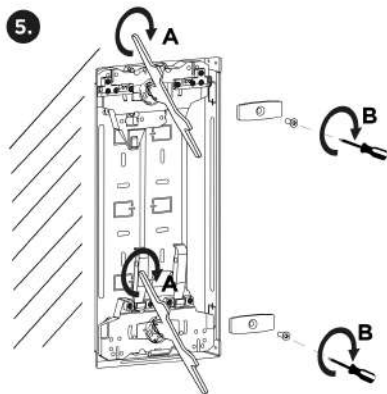

Make a hole of the size of 352 (h) x 167 (w) x 45 (d) mm for the mounting box installation. It is supposed that all the required cables have been carried into the hole. The recommended length of the accessible cables is 35 cm. Remove the selected mounting box blank for cabling. Thread the cables through the selected box hole and put the mounting box in the pre-prepared hole. Make sure that the mounting box hole is deep enough and that the box edges are aligned with the wall surface. If the hole is convenient, anchor the box using screws and dowels (1).

Insert the enclosed detents in the riveting nuts. Make sure that the tops of the detents direct towards the box center against each other. The detent with 2 handles is intended exclusively for the box bottom installation. Fit the detents with screws (2).

If the position of the detents seems to be too deep, untighten the screw to remove the detent fixture (3), insert a levelling key in the levelling mechanism grooves and turn it to adjust the required level (4). The levelling mechanism allows for a shift of up to 8 mm in height.

After levelling re-anchor the fixture with a screw (5).

Use a levelling key to check the proper height of detent embedding to make sure that the key is aligned with the mounting box edge and also touches the detent surface (6).

Put the brackets to the left and right sides of the bottom detent handle (7A) and fit their positions using screws (7B).

Now the mounting box installation is complete (8).

 **Download**

[Drilling Template](#)

2.3 Electric Installation

2N IP Style can be fed either from an external 12V / 4 A DC power supply or from a PoE+ 802.3at supporting LAN.

External Power Supply

For reliability reasons, use a 12 V $\pm 15\%$ SELV supply dimensioned to the current consumption as required for feeding of the main unit and connected extending modules.

DC voltage [V]	Load [A]	Max power [W]
12	3	36
12	4	48

PoE+ Supply

2N IP Style is compatible with the PoE+ 802.3at technology and can be supplied directly from the LAN via compatible network elements. If your LAN does not support this technology, insert a PoE injector, **Part No. 91378101**, between **2N IP Style** and the nearest network element. This power supply provides **2N IP Style** with 21.6 W for feeding of the main unit and connected modules.

⚠ Caution

- The PoE power supply cannot provide **2N IP Style** with a full functionality as it only offers a limited mode (Low Power Mode) for basic configuration. This way of feeding is not recommended. Connect the device to a PoE+ supply or a convenient DC supply and restart the device.
- The PoE power supply detection is performed during the device restart.
- If PoE supply is used and the device works in a low power mode:
 - a power problem notification is displayed in all the setting sections,
 - the display backlight is limited (to 25% of the programmable brightness value),
 - the device status indicating LED on the front side is unfunctional,
 - any module connected via the vbus cable is unfunctional.

Combined Power Supply

2N IP Style can be fed from an external power supply and PoE+ at the same time. In this mode, the maximum power of 48 W (if a 12V / 4A DC external supply is used) or 36 W (if a 12V / 3A DC supply is used) is available for feeding the main unit and connected modules.

⚠ Warning

- In case the external power supply is disconnected / fails during the combined external / PoE feeding, the device will get restarted. The device will run in the Low Power Mode and a feeding problem warning will be displayed in all of the configuration sections.
- Reconnect the device to an external power supply or PoE+ and force restart to recover the full functionality.

Main Unit Max Power Overview

Main Unit	Consumption [W] (Maximum value)		
	mA (from 12V supply)	W (from 12V supply)	W (from PoE+)
Idle	505	6.06	7.13

Restart	700	8.4	9.88
Infrared light (100%)	655	1.8	2.12
Display backlight intensity (100%)	950	4.8	5.65
Audio (100 %)	1420	10.98	12.92
Video motion detection	20	0.24	0.28
OUTPUT	600	7.2	8.47
RFID ON	550	0.54	0.64
Pictogram backlight (100 %)	570	0.24	0.28
Video streaming (ON)	530	0.3	0.35
CPU (100 %)	50	0.6	0.71
Memory (100 %)	25	0.3	0.35
GPU (100 %)	50	0.6	0.71
3 x Stream H.264 (1920 x 1080) MJPEG (1280 x 720)	50	0.6	0.71
Maximum Power Consumption	5 925	33.66	39.61

LAN Connection

2N IP Style is connected to the Local Area Network (LAN) via the UTP/STP cable (Cat 5e or higher) terminated with an RJ-45 (LAN) connector. As the device is equipped with the Auto-MDIX function, you can use either the straight or crossed cable version.

⚠ Caution

- We recommend the use of a LAN surge protection.
- We recommend that an SSTP Ethernet cable with a shielded RJ-45 connector is used, which is connected to the switch (with the grounding option) using the same shielded connector. Thus, the device is grounded without the need to use grounding terminals.

✓ Tip

- Remove the protective connector cover to facilitate the threading of the UTP/STP cable RJ terminal into the device box.

⚠ Warning

- This product cannot be connected directly to the telecommunications lines (or public wireless LANs) of any telecommunication carriers (e.g. mobile communications carriers, fixed communications carriers, or internet providers). In the case of connecting this product to the Internet, be sure to connect it via a router.

Main Unit Connectors

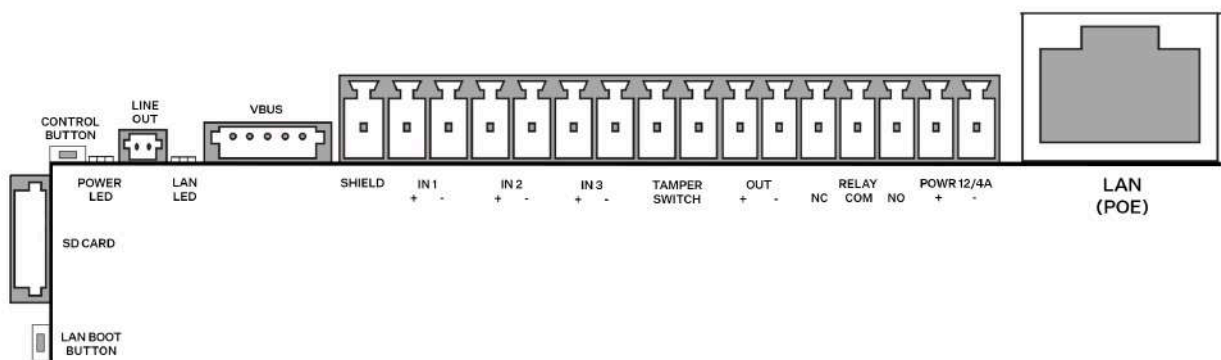

Legend to the figure	
LAN BOOT BUTTON	LAN connection restart button
SD CARD	SD card slot
CONTROL BUTTON	Factory reset button
POWER LED	Device status LED
LAN LED	LAN connection status LED
VBUS	Bus connector
SHIELD	Grounding terminal
IN1, IN2, IN3	Input terminals in passive / active mode (–30 V to +30 V DC) <ul style="list-style-type: none"> • OFF = open contact OR $U_{IN} > 1.5 \text{ V}$ • ON = closed contact OR $U_{IN} < 1.5 \text{ V}$
TAMPER SWITCH	Security system connecting terminals (on the back side above the connectors)
OUT	12 V / 0.6 A DC active output
RELAY	30 V / 1 A AC/DC NO/NC contact terminals. Used for connection of non-critical devices only (lights, e.g.).
POWER 12 V / 4 A	External 12 V / 4 A DC power supply terminals
LAN connector	Optionally PoE+ 802.3at for device LAN connection
Tamper Switch	Switch detecting unauthorized device opening

⚠ Caution

- We recommend that a grounding cable of the cross-section of 1.5 mm² is used.

Available Switches

Location	Name	Description
Basic Unit	RELAY	Passive switch: make and break contact, up to 30 V / 1 A AC/DC Used for connection of non-critical devices only (lights, e.g.).
	OUT	Active switch output: 10–12 V / 600 mA DC
I/O* Module (Part No. 9155034)	ext. relay1	Passive switch: make and break contact, up to 30 V / 1 A AC/DC Used for connection of non-critical devices only (lights, e.g.).
	ext. relay2	Passive switch: make and break contact, up to 30 V / 1 A AC/DC Used for connection of non-critical devices only (lights, e.g.).

You can use any number of the modules marked with *.

✔ **Tip**

- Relay output wiring diagram

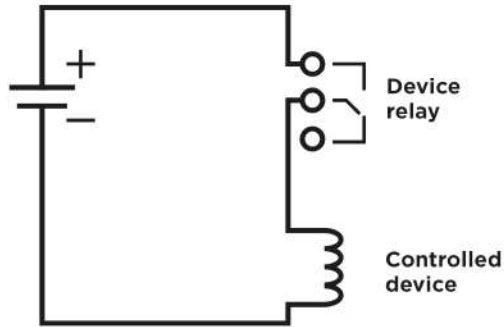

Wiring diagram for making of the electric circuit of the device to be controlled

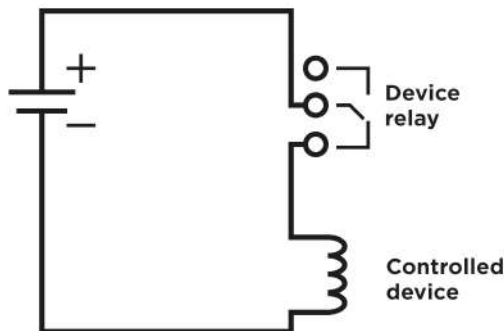

Wiring diagram for breaking of the electric circuit of the device to be controlled

✓ **Tip**

- Wiring Diagram of IN1 connector in active mode

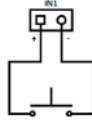

- Wiring Diagram of IN1 connector in passive mode

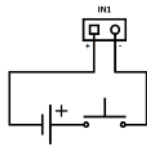

⚠ **Security**

- The 12V output is used for lock connection. If, however, the unit (2N IP Intercom, 2N Access Unit) is installed where unauthorized tampering may happen (building envelopes), we strongly recommend that 2N Security Relay (Part No. 9159010) be used for enhanced installation security.

Warning

If a coil containing device is connected, e.g. a relay / electromagnetic lock, it is necessary to protect the intercom output against voltage peak while switching off the induction load. For this way of protection, we recommend a 1 A / 1000 V diode (e.g., 1N4007, 1N5407, 1N5408) connected antiparallel to the device.

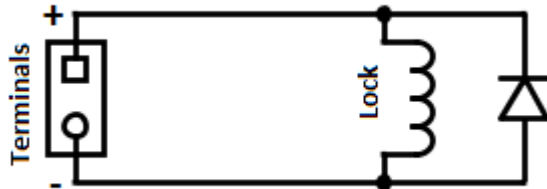

2.3.1 Overvoltage Protection

Recommendations for Additional Overvoltage Protection Installation

If running:

- a) outside a building,
- b) on/in an outer wall or roof,

the 2N device wiring may be exposed to atmospheric effects resulting in overvoltage that may subsequently damage any devices installed outside the building, on its outer wall or roof. Overvoltage may damage devices connected to these wires and installed inside the building as well. Therefore, we recommend that additional surge protectors be installed on all the wires leading outside buildings, on outer walls or roofs, namely:

- a) as close as possible to the device installed outside the building or on its outer wall/roof,
- b) as close as possible to the point where the wires leave the building.

Examples of Overvoltage Protection Installation:

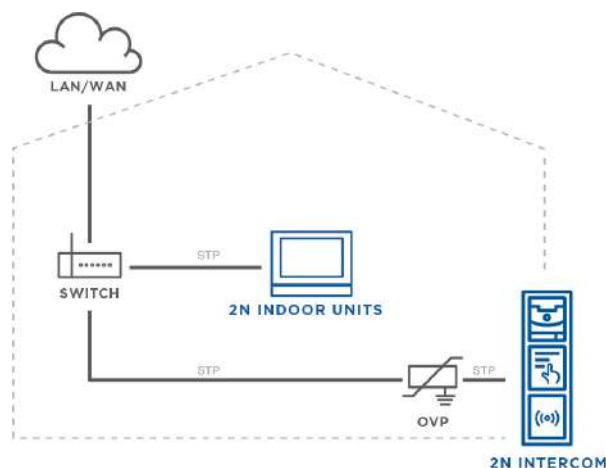

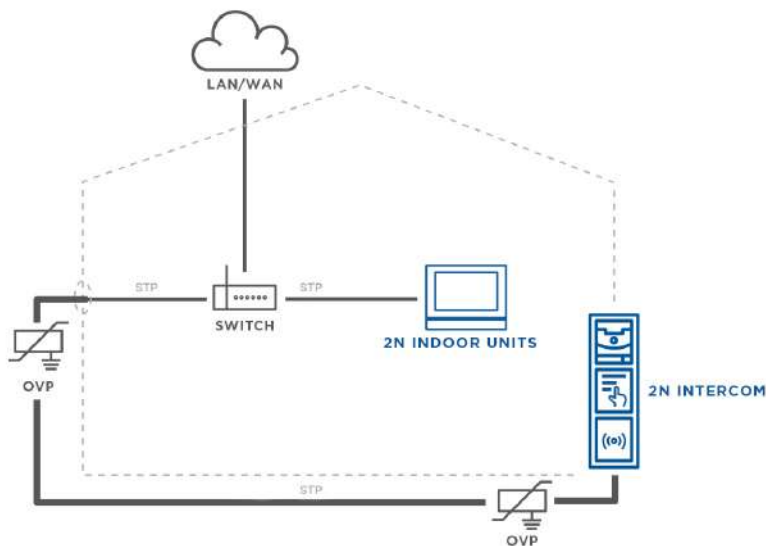
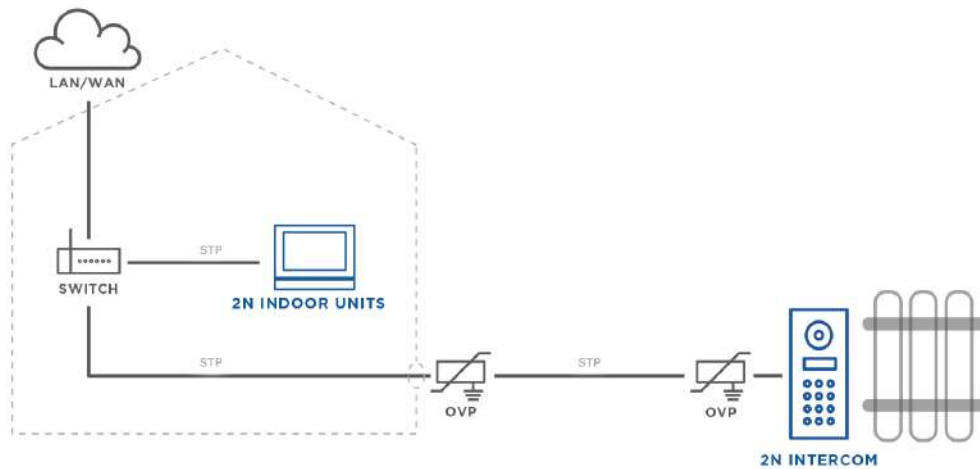

OVP = overvoltage protection

2.4 Extending Module Connection

The **2N IP Style** functions can be extended by connecting any of the available 2N IP Verso extending modules via the VBUS connector. Choose the proper accessories for each type of extending module installation.

- 125 kHz RFID card reader
- 13.56 MHz NFC RFID card reader
- Secured 13.56 MHz NFC RFID card reader

- Induction loop
- Fingerprint scanner
- Wiegand module
- OSDP module
- I/O Module
- Tamper switch

⚠ Caution

- In case the firmware versions of the module to be connected and the main unit are incompatible, the module will not be detected. Therefore, it is necessary to update the device firmware after the modules are connected. Use the device web interface in the System > Maintenance > System configuration section for firmware upgrade (see [Configuration manual for 2N IP intercoms](#)).

Module Bus Interconnection

All the extending modules, except for the tamper switch, are interconnected via a bus. The bus starts on the basic unit and goes over all the modules. The order of modules on the bus is irrelevant. And it is also irrelevant which bus connector on the module is used as the input and which is used as the output.

The modules include a 220 mm long interconnecting cable, the Wiegand (**9155037**) and I/O (**9155034**) modules include an 80 mm long bus cable.

It is possible to order separate bus cables of the length of 1 m, 3 m or 5 m (**Part No. 9155050/9155054/9155055 respectively**), which are intended for remote module installations. Typically, they help install an RFID card reader on the opposite side of the wall on which **2N IP Style** is installed. This cable may only be used once on the bus. The total length of all the bus cables used in these extended installations may not exceed 7 m.

⚠ Caution

- Purchase a frame / mounting box for the extending modules to be connected according to the type of installation. This does not apply to the I/O, Wiegand and tamper switch extending modules.

Module Power Supply

All the **2N IP Style** modules, except for the tamper switch, are powered from a bus. The available bus power output depends on the power supply type. The basic unit can use a 4A power supply to increase the power available to the modules connected.

Power supply	Specification	Available power output
External supply	12 V ±15 % / 4 A DC	up to 48
PoE+	802.3at	up to 21.6 W
Combined	External supply + PoE+	

125 kHz RFID Card Reader Module

The 125 kHz RFID card reader (**Part No. 9155032**) is one of the 2N IP Verso system elements and is used for reading RFID card IDs in the 125 kHz band.

- The module contains two **2N IP Style** bus connectors.
- These two connectors are fully interchangeable and can be used either as inputs from the basic unit or outputs to other modules.
- If this module is the last one on the bus, one of the connectors remains unconnected.
- The module package includes a 220 mm long interconnecting cable.

The following RFID cards can be read:

- EM4xxx

⚠ Caution

- We recommend that the M-Bus and LAN cables are not crossed but carried separately through one bushing to increase the reading distance of this reader if combined with a touch display in a single installation.

13.56 MHz RFID Card Reader Module

The 13.56 MHz RFID card reader (**Part No. 9155040**) is one of the 2N IP Verso system elements and is used for reading RFID card IDs in the 13.56 MHz band.

- The module contains two **2N IP Style** bus connectors.
- These two connectors are fully interchangeable and can be used either as inputs from the basic unit or outputs to other modules.
- If this module is the last one on the bus, one of the connectors remains unconnected.
- The module package includes a 220 mm long interconnecting cable.

The following RFID cards can be read:

- ISO14443A (MIFARE DESFire)
- PicoPass (HID iClass)
- FeliCa
- ST SR(IX)
- **2N Mobile Key**

Secured 13.56 MHz NFC RFID Card Reader

The 13.56 MHz RFID card reader (**Part No. 9155086**) is one of the 2N IP Verso system elements and is used for reading secured RFID card IDs in the 13.56 MHz band.

- The module contains two **2N IP Style** bus connectors.
- These two connectors are fully interchangeable and can be used either as inputs from the basic unit or outputs to other modules.
- If this module is the last one on the bus, one of the connectors remains unconnected.
- The module package includes a 220 mm long interconnecting cable.

The following RFID cards can be read:

- ISO14443A (MIFARE DESFire)
- PicoPass (HID iClass)
- FeliCa
- ST SR(IX)
- **2N Mobile Key**
- HID SE (Seos, iClass SE, MIFARE SE)

Induction Loop Module

The Induction loop module (**Part No. 9155041**) is one of the 2N IP Verso system elements and is used for transmitting audio signals directly into a hearing aid via a magnetic field.

- The module contains two **2N IP Style** bus connectors.
- These two connectors are fully interchangeable and can be used either as inputs from the basic unit or outputs to other modules.
- If this module is the last one on the bus, one of the connectors remains unconnected.
- The module package includes a 220 mm long interconnecting cable.

- Used mode: T
- Maximum power: 2 W
- Frequency range: 100 Hz – 5 kHz / ± 3 dB
- External antenna (**Part No. 9155043**) connection option
- Antenna output short circuit resistance: without limitation

Fingerprint Reader Module

The Fingerprint reader (**Part No. 9155045**) is one of the 2N IP Verso system elements and is used for verification of human fingerprints for access control and intercom / third party equipment control.

- The module contains two **2N IP Style** bus connectors.
- These two connectors are fully interchangeable and can be used either as inputs from the basic unit or outputs to other modules.
- If this module is the last one on the bus, one of the connectors remains unconnected.
- The module package includes a 220 mm long interconnecting cable.

Important module properties:

- FBI PIV and Mobile ID certification – FAP20
- Durable glass touch surface
- Rejection of spoof fingerprints
- Operating temperature range: –20 to 55 °C
- 0–90 % relative humidity, noncondensing

Warning

- The fingerprint reader is not intended for direct sunlight installation sites. Installation at such places may result in erroneous behavior.

Caution

- A higher moisture may deteriorate the finger papillary line scanning. You are advised to dry your finger and the reader scanning surface for successful authentication.
- Fingerprint scanning may be more difficult for seniors whose finger papillary lines are not so distinctive (skin elasticity drops with age and a higher scanning pressure may lead to fingerprint blurring).

Wiegand Module

The Wiegand module (**Part No. 9155037**) is one of the 2N IP Verso system elements and is used for connecting an external Wiegand device (RFID card reader, fingerprint/ biometric data

scanner) and/or connecting the intercom to an external security exchange. All the inputs and outputs are galvanically isolated from the intercom with the insulation strength of 500 V DC. It is necessary to feed +U IN on Wiegand OUT from the Control Panel.

- **Reader** – connects an external Wiegand-supporting reader. The reader sends information on the intercom card number.
- **Control Panel** – used for connection to the security PBX / access system to which the intercom sends the card number information.
- The module contains two **2N IP Style** bus connectors.
- These two connectors are fully interchangeable and can be used either as inputs from the basic unit or outputs to other modules.
- If this module is the last one on the bus, one of the connectors remains unconnected.
- The module package includes a 80 mm long interconnecting cable.

Configure the module name in the Module name parameter in the Hardware / Extending modules menu.

- The LED IN input is addressed as follows: **<module_name>.<input1>**, e.g. module2.input1.
- The Tamper input is addressed as follows: **<module_name>.<tamper>**, e.g. module2.tamper.
- The LED OUT output (negated) is addressed as follows: **<module_name>.<output1>**, e.g. module2.output1.

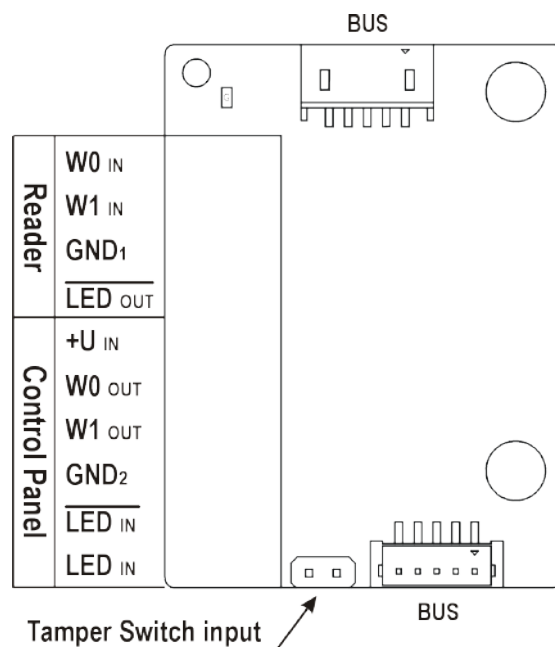

Reader	W0 IN, W1 IN, GND1	Isolated 2-wire WIEGAND IN
	LED OUT	Isolated open LED OUT switched against GND1 (up to 24 V / 50 mA)
Control Panel	+U IN	+U input (5 to 15 V DC) for WIEGAND OUT power supply
	W0 OUT, W1 OUT, GND2	Isolated 2-wire WIEGAND OUT
	LED IN (negated)	Isolated input for open LED IN, input activated by GND ₂ connection
	LED IN	Isolated input for open LED IN, input activated by +U connection
	G	+UIN WIEGAND OUT active supply LED indicator
	TAMPER	Tamper switch (Part No. 9155038) input
Technical Parameters of Wiegand Input		
Current		5 mA
Input resistance		680 Ohm
Pulse length		50 μs
Inter-pulse interval		approx. 2 ms

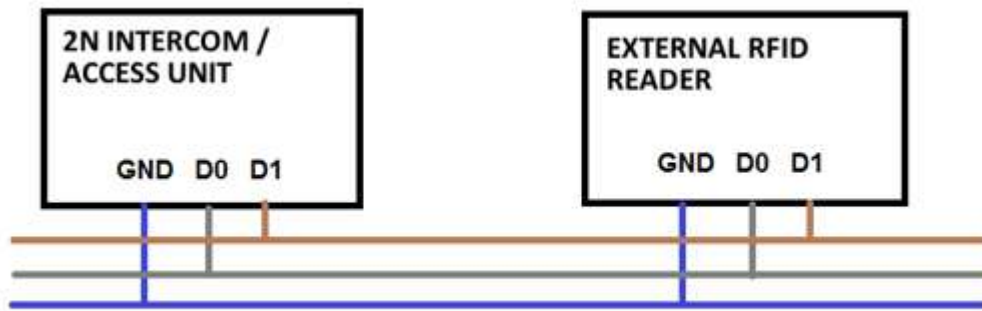

Recommended reader - bus driver wiring diagram

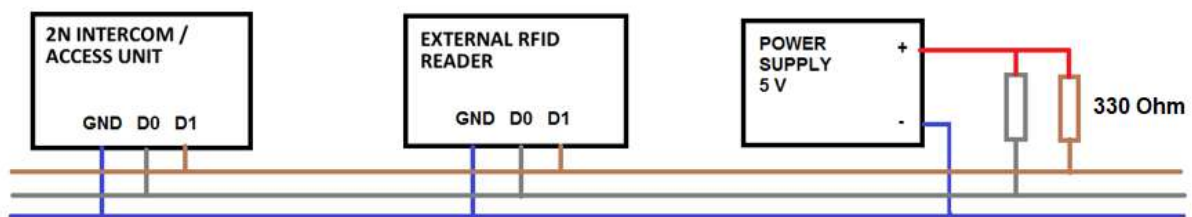

Recommended reader wiring diagram with OC output

OSDP Module

The OSDP module (Part No. **91550371**) is one of the 2N IP Verso modules and provides communication between a connected device (control panel, door controller) and **2N IP Intercom** via the OSDP. The OSDP module provides secure sending of such access data as the access card ID or PIN code. All the inputs and outputs are galvanically isolated from the **2N IP Intercom** system with insulation strength of 500 V DC.

- The module contains two VBUS connectors for device bus connection.
- These two connectors are interchangeable and can be used either as inputs from the basic unit or outputs to other modules.
- If this module is the last one on the bus, one of the connectors remains unconnected.
- The module package includes a 80 mm long interconnecting cable.

The module also includes:

- Isolated OSDP bus
- Power and pairing mode signaling LED

- Tamper switch (9155038) input

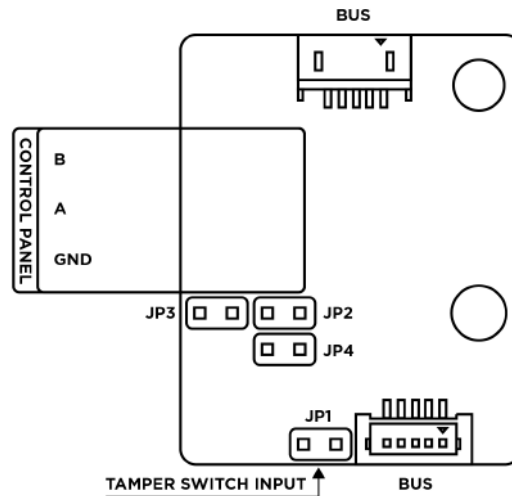

Installation Procedure

Having connected the **OSDP module** to **2N IP Style** via the VBUS, connect the OSDP device to the module. The **OSDP module** uses the RS-485 bus for the interface.

Connect the OSDP device as instructed (A to B or B to A) keeping the correct order to avoid malfunction.

⚠ Caution

- When the JP2 and JP3 jumpers are mounted, strong pull-up / pull-down resistors (560 ohm) are connected to the RS-485 bus. These jumpers must be mounted / unmounted together, i.e. you cannot mount just one of them. The strong pull-up / pull-down resistors can be connected only and exclusively to one arbitrary device on the OSDP bus.
- When the JP4 jumper is mounted, a 120 ohm termination resistor is placed between the A and B wires of the OSDP bus. The termination resistors can be connected exclusively to the first and last OSDP bus modules. We recommend that these resistors are connected to the first and last modules.

Having logged in to the **2N IP Style** web interface, use the *HW / Extending Modules* menu to set the following:

- Give the module a user identification (optional).
- Choose a group for access data resending, making sure that the settings are identical with those of the access readers from which the data are to be resent (card ID < PIN).
- The settings of the codes to be transmitted are optional.
- Enter the OSDP address between 0 and 126 to set the OSDP module address on the OSDP line.
- Set the communication rate in accordance with the requirements of the device to be connected.
- Enter your own encryption key into **2N IP Style** and the opponent's device to ensure encrypted communication.
- Enable forced encryption just for encrypted communication.

Any unencrypted communication from the OSDP device will be rejected if forced encryption is enabled.

If the OSDP device enables remote encryption key setting on a peripheral, you can use the installation mode. Once the encryption key is received, the common mode is automatically switched on. The installation mode is signaled by a LED fast blinking on the **OSDP module**.

I/O Module

The I/O module (**Part No. 9155034**) is one of the 2N IP Verso intercom elements and is used for extending the number of inputs and outputs.

- The module contains two **2N IP Style** bus connectors.
- These two connectors are fully interchangeable and can be used both as inputs from the main unit and outputs to other modules.
- If this module is the last one on the bus, one of the connectors remains unconnected.
- The module package includes an 80 mm long interconnecting cable.

- The inputs / outputs are addressed as follows: **<module_name>.<input/output_name>**, e.g. module5.relay1. The module name is configured in the Module name parameter in the Hardware / Extenders menu.

RELAY1	RELAY1 terminals with accessible 30 V / 1 A AC/DC NO/NC contact
RELAY2	RELAY2 terminals with accessible 30 V / 1 A AC/DC NO/NC contact
IN1	IN1 terminals for input in passive/ active mode (–30 V to +30 V DC) OFF = open OR $U_{IN} > 1.5 \text{ V}$ ON = closed contact OR $U_{IN} < 1.5 \text{ V}$
IN2	IN2 terminals for input in passive/active mode (–30 V to +30 V DC) OFF = open OR $U_{IN} > 1.5 \text{ V}$ ON = closed contact OR $U_{IN} < 1.5 \text{ V}$
TAMPER	Tamper switch (9155038) input

Tamper Switch Module

The Tamper switch module (**Part No. 9155038**) is one of the 2N IP Verso system elements and helps secure the system against tampering.

- The module contains two switches, which open whenever the front frame is removed:
 - One switch leads directly to the terminal board and is connected to an external security exchange (32 V DC / 50 mA max).
 - In coordination with the **I/O module (9155034)** or **Wiegand module (9155037)**, the other switch can be used for initiating alarm via the Automation interface in the **2N IP Style** configuration.
 - This module is not connected to the bus.

Caution

- Remember to purchase the I/O module, Part No. 9155034, along with the tamper switch.

3. Function and Use

This section describes the basic and extending functions of the **2N® IP Style** product.

Here is what you can find in this section:

- [3.1 Configuration](#)
- [3.2 2N® IP Style User Control](#)
- [3.3 Intercom Control as Viewed by Internal User](#)
- [3.4 Maintenance](#)
- [3.5 Downloads](#)

3.1 Configuration

Configuration takes place typically via a web interface. Alternatively, configuration is possible using the **2N® Access Commander** software or the **My2N** service.

Configure **2N® IP Style** using your PC equipped with any Internet browser:

- Launch your Internet browser (Chrome, Firefox, Internet Explorer, etc.).
- Enter the IP address of your intercom (<http://192.168.1.100/>, e.g.).
- Log in using the username **Admin** and password **2n**.

You have to know the IP address of your device to log in to the integrated web server. Upon purchase, **2N® IP Style** is set to the dynamic IP address mode – it retrieves the IP address automatically if there is a properly configured DHCP server in the LAN. If no DHCP is available, **2N® IP Style** can be operated in the static IP address mode. Refer to the [Configuration Manual for 2N IP Intercoms](#) for the **2N® IP Style** configuration details.

If your device remains inaccessible (you have forgotten the IP address or the LAN configuration has changed, for example), change the LAN settings using the hidden menu on the device.

Hidden Menu Launch

Wait until the end of the introductory animation on the display after starting/restarting the device. The moment the home screen appears (after approx. 20 s), place your finger in the left-hand upper corner of the display for approx. 5 s.

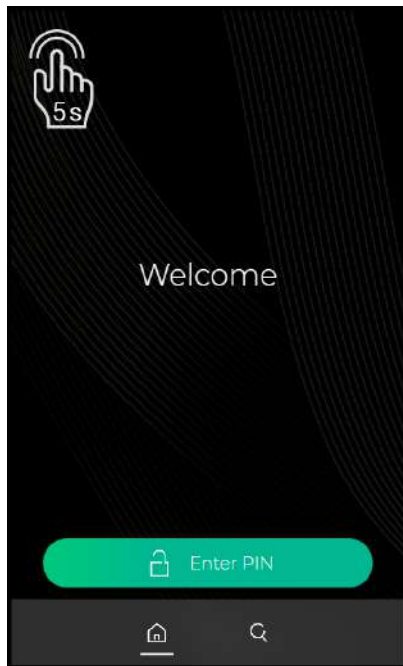

IP Address Retrieval

The IP address of the device will be shown in the hidden menu. The menu contains the network mask, default gateway address and DHCP switch among others.

✓ Tip

- To retrieve the device IP address you can also use 2N® Network Scanner, which can be freely downloaded from www.2n.com.

If the address is 0.0.0.0, then the device did not get the IP address from the DHCP server and the static IP address (DHCP OFF) has to be used. If DHCP OFF is set, the device static address is 192.168.1.100.

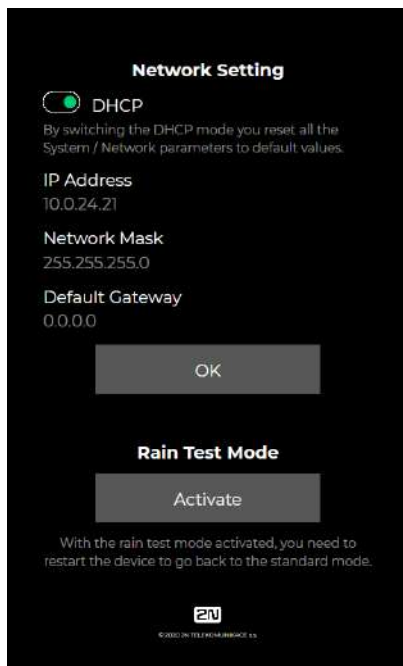

Rain Test Mode

The rain test mode shows where the presence of water has been detected on the display. Once the mode is activated, a black screen is displayed showing the water contact spots. Tap quickly three times on any display spot to delete the impact records.

2N® IP Style does not support the intercom functions (e.g. calls cannot be made, cards cannot be read on the device) during the test. Restart the device to quit the rain test mode and return to the standard mode.

Device Restart

To restart the device, disconnect the device from the power supply or use the web interface in the System / Maintenance section. No configuration change appears after the restart.

Caution

- Do not touch the display during restart, it is being calibrated.

Factory Default Reset

Located among the main unit connectors, the CONTROL button helps you reset the factory default values.

Follow the instructions below to reset the factory default values:

- Disconnect the device from the power supply.

- Press and hold the CONTROL button.
- Connect the device to the power supply.
- Keep holding the button for a few seconds and then release it.

Caution

- If **2N® IP Style** is supplied from an external power source using terminals, the factory reset is performed only if the device is disconnected from the LAN too.

Firmware Upgrade

Use the device web interface in the System / Maintenance / System configuration section for firmware upgrade. Refer to 2n.com for the latest firmware version. The **2N® IP Style** firmware also includes the up-to-date touch display controller. The display touch layer showing the ongoing upgrade notification does not respond during the upgrade. The device restarts automatically after the upgrade is completed successfully. The whole process takes almost one minute.

Warning

- Firmware downgrade in Artpec equipped devices results in factory reset and loss of the whole configuration including the license keys. Therefore, we recommend that you back up the configuration and save the valid license key before such downgrade.

3.1.1 2N® IP Style LAN Location via 2N® Network Scanner

2N® IP Style is configured via the administration web server. Connect the device to the LAN IP and make sure it is properly powered.

2N® Network Scanner Description

The application helps find the IP addresses of the 2N devices in the LAN. Download the app from the 2N web sites (www.2n.com). Make sure that Microsoft .NET Framework 2.0 is installed for successful app installation.

1. Run the **2N® Network Scanner** installer.
2. Use the Setup Wizard for successful installation.

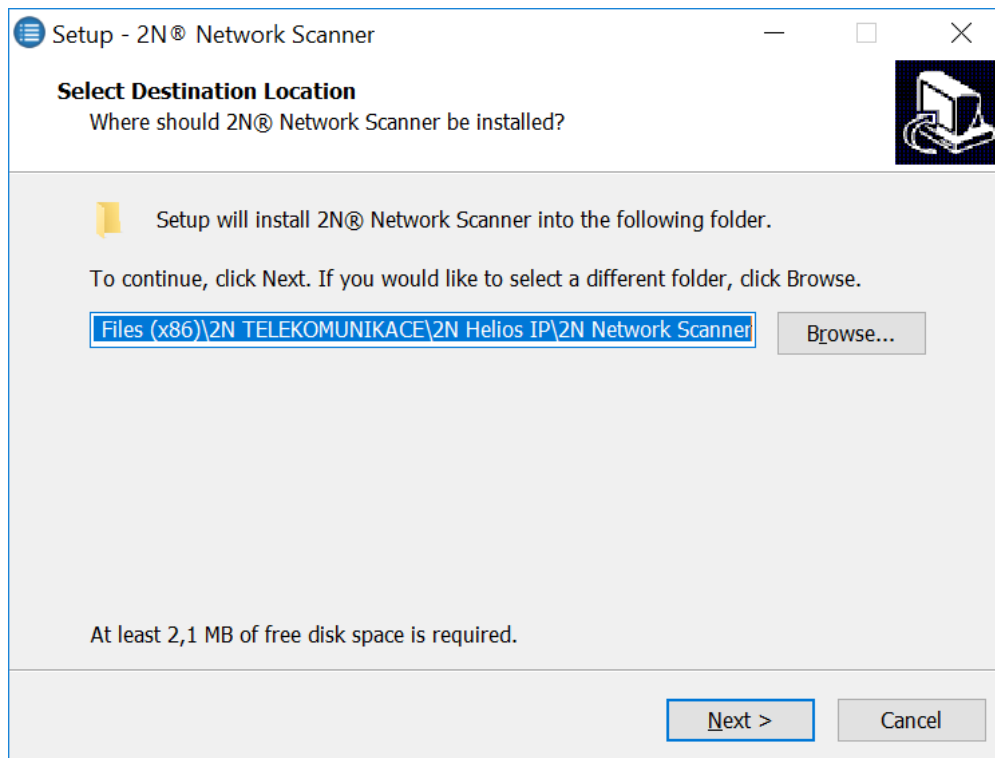

Setup Wizard of 2N® Network Scanner

3. Having installed **2N® Network Scanner**, start the application using the Microsoft Windows Start menu.

Once started, the application begins to automatically search for all the 2N devices in the LAN including their smart extensions which are DHCP/statically assigned IP addresses. All the devices are then displayed in a table

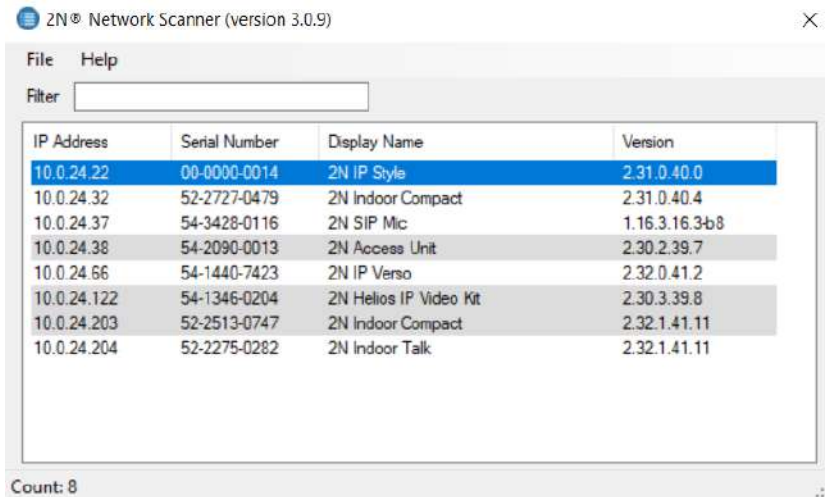

Window of **2N® Network Scanner**

1. Select the **2N® IP Style** device to be configured and right-click it. Select *Browse...* to open the **2N® IP Style** administration web interface login window for configuration. To change the device IP address, select *Config* and enter the required static IP address or activate DHCP. The default configuration password is: 2n. If the found device is grey highlighted, its IP address cannot be configured using this application. In that case, click Refresh to find the device again and check whether multicast is enabled in your network.

 **Tip**

- Double click the selected row in the **2N® Network Scanner** list to access the device web interface easily.

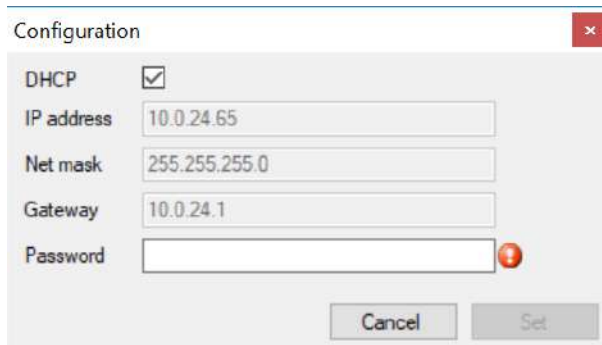

2N® Network Scanner IP Address Change

3.2 2N® IP Style User Control

Sleep Mode

2N® IP Style switches to the Sleep mode after an idle timeout (default value is 60 s). In the Sleep mode, you can go to the Showcase mode to display a presentation or the company logo/address (see Subs. [5.3.8 Display](#) of the Configuration Manual for IP Intercoms).

Touch any part of the display to cancel the Sleep mode and display the home page.

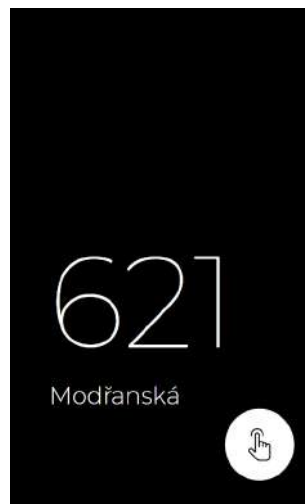



Sleep Mode

⚠ Caution

- After a 2-minute idle time, the screen saver is launched on **2N® IP Style**, in which the display brightness value goes up and down alternately in 20-second intervals. The screen saver mode is terminated by a screen touch, access attempt, incoming call, notification display or motion detection even in case the motion detection function is disabled. If the screen saver is running on the background in the Showcase mode, the termination by a touch also switches the device onto the home page.

Home Page

The home page displays the group / user name list to be called. Use the icon  to display a full-text array to retrieve contacts in the device directory. Also, the possibility to enter the access code via the touch numeric keypad is offered.

If configured so, the home page can provide the possibility to call user virtual numbers  or get access via the **2N® Mobile Key** mobile application under the icon .

The icon  helps you return to the home page.

Calling to Phone Book Position

2N® IP Style displays the group / user name list. The **2N® IP Style** Phone Book can contain up to 10 000 pre-programmed positions. The group / user list can be displayed as a classic name list or as a set of cards (refer to Subs. [5.3.8 Display](#) of the Configuration Manual for IP Intercoms). The user groups are superior to the users, the list is arranged in the alphabetical order.

Press  to display a full-text array to retrieve a user by entering a few letters representing the user name. All options are displayed from the list that contain the searched string.

Procedure:

- Touch the screen with your finger and move up and down to scroll up and down in the group / user list.
- Touch a selected user list position / card with your finger to make an outgoing call to the user. An outgoing call will be set up.
- Press the  red button any time to end the call.

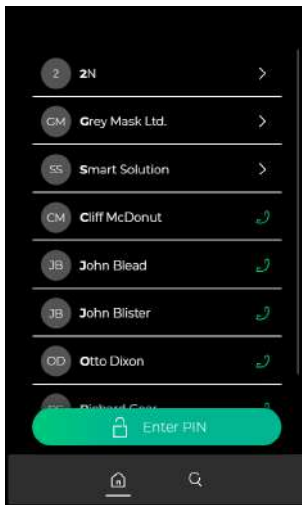

Name List

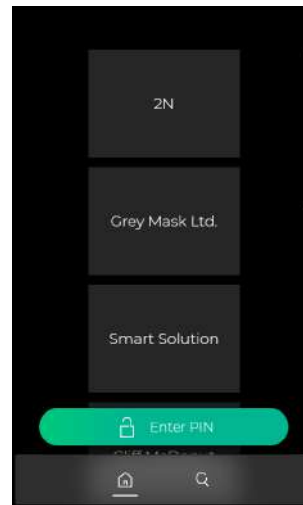



Cards



Virtual Number Call

If the **Phone function enabled** (refer to Subs. [5.4.1 Phone](#) of the Configuration Manual for IP Intercoms) parameter is selected, you can dial a user-defined phone number using the **2N® IP Style** numeric keypad.

Procedure:

1. Press the  button.
2. Enter the phone number using the numeric keypad and repress the  green button for confirmation.
3. Press the  red button any time to end the call.

Incoming Call Answering/Rejecting

If the automatic incoming call answering function is disabled (refer to Subs. [5.4.1 Phone](#) of the Configuration Manual for IP Intercoms), any incoming call to **2N® IP Style** is signaled with loud ringing. Push the  button to answer the call and the  button to reject the call.

Door Opening (Switch Activation) by RFID Card

2N® IP Style is equipped with a door unlocking switch. To activate this switch, tap a valid card or chip on the integrated card reader. Remember to complete the user access card ID (refer to Subs. [5.2.1 Users](#) of the Configuration Manual for IP intercoms) to get an RFID card / chip access.



Procedure:

- Tap a valid RFID card / chip on the integrated card reader located in the bottom part of the device, whose symbol is backlit.
- A valid authentication is notified visually and by a continuous switch activation tone or a predefined unlocking user sound. An invalid RFID card / chip use is signaled acoustically  or using a user sound.

Door Opening (Switch Activation) by Code

2N® IP Style is equipped with a door unlocking switch. Enter the valid code (refer to Subs. [5.3.1 Switches](#) of the Configuration Manual for IP Intercoms) using the touch numeric keypad to activate this switch.



Procedure:

- Enter the switch activating numeric code using the touch numeric keypad and press the  lock button for confirmation.
- A valid authentication is notified visually and by a continuous switch activation tone or a predefined unlocking user sound. An invalid code or interruption longer than as defined in **Timeout for Entering Numbers**, is signaled acoustically  or using a user sound.

Door Opening (Switch Activation) by 2N® Mobile Key



2N® IP Style is equipped with a door unlocking switch. Activate this switch using the **2N® Mobile Key** authentication (refer to Subs. [5.4.5 Mobile Key](#) of the Configuration manual for IP Intercoms) in your smartphone. The application is available for devices with iOS 12 and higher (iPhone 4s and higher) or Android 6.0 Marshmallow and higher (Bluetooth 4.0 Smart supporting phones).

Procedure:

- According to the authentication mode:
 - **Touch mode** – press  or drag  from left to right on the display (depending on the Bluetooth authentication setting) to activate the switch.
 - **Tap in app mode** – unlock your smartphone, open the app and press the virtual button to activate the switch.
 - **Motion mode** – motion has to be detected by the intercom camera to activate the switch. Arrival in the proximity or waving of the hand will do.
 - **Card mode** – move your smartphone close to the integrated RFID card reader to activate the switch.
- A valid authentication is notified visually and by a continuous switch activation tone or a predefined unlocking user sound. An invalid authentication is signaled acoustically  or using a user sound.

Signaling LED

Signaling LED pictograms can be displayed in the notification bar area at the display upper edge.

If the red lock pictogram  is active, i.e. displayed in the notification bar area, it means that the **2N® IP Style** installation site is secured. It is possible to activate the area security by, e.g., assignment to physical input, via HTTP API, etc. If the green door pictogram  is active, it means that the door opening switch is active. See above for how to open the door (activate the switch).

3.3 Intercom Control as Viewed by Internal User

Call Answering

You can answer incoming calls from **2N® IP Style** using your phone like any other calls. You can unlock the door, activate/deactivate a user/profile via your phone keypad during the call. The calls, however, are time-limited to avoid unintentional blocking of the **2N® IP Style** line. Set the maximum call duration in the Call time limit parameter (refer to Subs. [Phone / Calls](#) of the Configuration Manual). Press # on your phone anytime to extend the call time. The automatic call termination is signaled with a short beep 10 s before the call end.



Calling to 2N® IP Style

2N® IP Style allows you to answer incoming calls. Set the required parameters in the Incoming calls group (refer to Subs. [Phone / Calls](#) of the Configuration Manual).

Door Opening (Switch Activation) by Code

2N® IP Style is equipped with a door unlocking switch. Enter the valid code (refer to Subs. [Hardware / Switches](#) of the Configuration Manual) using your phone keypad to activate this switch.

Procedure:

- Enter the switch 1 or 2 activating code using your phone keypad and press  for confirmation. (Confirmation is unnecessary if the Lock code without confirmation is enabled, refer to the Hardware / Switches / Advanced subsection).
- A valid code is signaled acoustically . An invalid code or interruption longer than as defined in **Timeout for Entering Numbers**, is signaled acoustically .

Note

- Codes 00 and 11 are reserved for DTMF-based door opening.

3.4 Maintenance

If used frequently, the device surface gets dirty. Use a piece of soft cloth moistened with clean water to clean the device. It is recommended that the principles below are followed while cleaning:

- Do not use aggressive detergents (such as abrasives or strong disinfectants).
- Use suitable cleaning agents for glass lens cleaning (cleaners for glasses, optical devices, screens, etc.).
- Clean the device in dry weather in order to make waste water evaporate quickly.
- We recommend that IT cleaning wipes are used.

Anticovid

- To disinfect the surface of the device against bacteria and viruses (Anti-Covid) and maintain the hygienic conditions of critical surfaces and touch points, we recommend that you use the Zoono – Microbe Shield Surface Sanitiser spray.

Warning

- Prevent water from getting inside the intercom.
- Do not use alcohol-based cleaners.
- Avoid peroxide-based cleaners.
- Do not use lye-based (sodium hydroxide) cleaners.

Caution

- Use the product for the purpose it was designed and manufactured for, in compliance herewith.
- The manufacturer reserves the right to modify the product in order to improve its qualities.
- **2N® IP Style** contains no environmentally harmful components. When the product's service life is exhausted, dispose of the product in accordance with applicable legal regulations.

3.5 Downloads

Software

[2N® USB driver](#)

[2N® IP Eye](#)

[2N® Network Scanner](#)

4. Technical Parameters

Signaling protocol

- **SIP (UDP, TCP, TLS)**

Audio

- **Microphone:** 2 integrated microphones
- **Amplifier:** 2 x 4 W (class D) amplifier
- **Speaker:** 2 x 4 W / 4 Ω
- **Sound pressure level (SPL max):** 85 dB (for 1 kHz, distance 1 m)
- **Output LINE OUT:** 1 VRMS / 600 Ω
- **Volume control :** adjustable with automatic adaptive mode
- **Full Duplex:** yes (AEC)
- **Speech transmission index (STI):** 0.89

Audio stream

- **Protocols:** RTP / RTSP / SRTP
- **Codecs:** G.711, G.729, G.722, L16/16kHz

Camera

- **Sensor:** 1/2.7" color CMOS
- **JPEG resolution:** up to 2560 (H) x 1920 (V), (4:3); max QHD (16:9)
- **Video resolution:** up to 2560 (H) x 1920 (V), (4:3); max QHD (16:9)
- **Frame rate:** up to 30 frames per s
- **Sensor sensitivity:** 14000 V/lux-sec
- **View angle:** 144 ° (H), 126 ° (V)
- **Infrared light:** yes
- **Sensor sensitivity without IR light:** 0.1 Lux ± 20 %
- **Focal length:** 1.7 mm

Video stream

- **Protocols:** RTP / RTSP / SRTP / HTTP
- **Video call codecs:** H.264
- **ONVIF/RTSP stream codecs:** H.264, H.265, MJPEG
- **IP camera function:** yes, ONVIF v2.4 profile S compatible

Bandwidth

- **Audio codecs**

- PCMA, PCMU – 64 kbps (with 85.6 kbps headers)
- G.729 – 16 kbps (with 29.6 kbps headers)
- G.722 – 64 kbps (with 85.6 kbps headers)
- L16 / 16 kHz – 256 kbps (with 277.6 kbps headers)

- **Video codecs**

Set the video codec data flows in the Services / Phone / Video menu for calls and in the Services / Streaming / RTSP menu for streaming. The set bandwidth represents the value that the codec has to approach on a long-time average. The data flows can vary depending on the scene to be scanned.

Interface

- **Power Supply:** 12 V \pm 15 % / 4 A DC or PoE+
- **PoE:** PoE+ 802.3at
- **LAN:** 10/100BASE-TX s Auto-MDIX, RJ-45
- **Recommended cabling:** Cat-5e or higher
- **Supported protocols:** SIP2.0, SIPS, DHCP opt. 66, SMTP, SNMP, TR069, 802.1x, RTSP, RTP, SRTP, TFTP, HTTP, HTTPS, Syslog, ONVIF
- **Passive switch:** NO and NC contacts, up to 30 V / 1 A AC / DC
- **Active switch output:** 10 – 12 V / 600 mA DC
- **Passive / active input:** –30 V to +30 V DC

RFID card reader

- **Supported 125 kHz cards**
- EM4xxx
- **Supported cards in 13.56 MHz NFC version** (only card ID is read)
 - ISO14443A (MIFARE DESFire)
 - PicoPass (HID iClass)
 - FeliCa
 - ST SR(IX)
 - **2N® Mobile Key**
- **Supported secured cards in 13.56 MHz NFC version**
 - HID SE (Seos, iClass SE, MIFARE SE)
- **Maximum H – field strength at 10 m for 125 kHz version: 1.492e-3 W/m²**
- **Maximum H – field strength at 10 m for 13.56 MHz version: 3.747e-4 W/m²**

Bluetooth

- **Bluetooth 4.2** in compliance with BLE (Bluetooth Low Energy)
- **Security:** asymmetric RSA-1024 and symmetric AES-128 encryption
- **Range:** adjustable (short ~ 2m, long ~ up to 10m)
- **Support of mobile applications:** Android 6 and higher, iOS 12 and higher

Touch display

- **Resolution:** 10.1” 1280 x 800 TFT IPS
- **Contrast ratio:** 800 : 1
- **Brightness:** 900 cd/m²
- **Viewing angle:** 85 ° from any direction
- **Numeric keypad:** touch numeric keypad
- **Touch buttons:** touch display
- **Directory:** residential / business (for 10 000 users)

I/O module (optional)

- **External**
- **Dimension:** 43 (W) x 31.5 (H) x 1.5 (D) mm

Wiegand module (optional)

- **External**
- **Dimensions:** 43 (W) x 31.5 (H) x 1.5 (D) mm

Mechanical properties

- **Cover:** Hardened glass
 - **Body:** EN-AW6060
 - **Surfacing:** Wet coating
 - **RAL**
 - **Body** – RAL 7021 dark grey
 - **Chassis** – RAL 7043
- **Operating temperature:** –30 °C to 60 °C
- **Working relative humidity:** 10 % – 95 % (non-condensing)
- **Storage temperature:** –30 °C to 70 °C
- **Dimensions**
 - **Surface mounting:** 170 (W) x 355 (H) mm x 40 mm (D)
 - **Flush mounting:** 170 (W) x 355 (H) mm x 22 mm (D)
- **Weight:** 1950 g
- **Cover rating:** IP65
- **Resistance level:** IK08

5. Supplementary Information

- [5.1 Troubleshooting](#)
- [5.2 Directives, Laws and Regulations](#)
- [5.3 Other Countries Legislation](#)
- [5.4 General Instructions and Cautions](#)

5.1 Troubleshooting



For the most frequently asked questions refer to faq.2n.cz.

5.2 Directives, Laws and Regulations

2N® IP Style conforms to the following directives and regulations:

- 2014/35/EU for electrical equipment designed for use within certain voltage limits
- 2014/30/EU for electromagnetic compatibility
- 2011/65/EU on the restriction of the use of certain hazardous substances in electrical and electronic equipment
- 2012/19/EU on waste electrical and electronic equipment

Industry Canada

This Class B digital apparatus complies with Canadian ICES-003/NMB-003.

FCC

This equipment has been tested and found to comply with the limits for a Class B digital device, pursuant to part 15 of the FCC Rules.

NOTE: These limits are designed to provide reasonable protection against harmful interference in a residential installation. This equipment generates, uses and can radiate radio frequency energy and, if not installed and used in accordance with the instructions, may cause harmful interference to radio communications.

However, there is no guarantee that interference will not occur in a particular installation. If this equipment does cause harmful interference to radio or television reception, which can be determined by turning the equipment off and on, the user is encouraged to try to correct the interference by one or more of the following measures:

- Reorient or relocate the receiving antenna
- Increase the separation between the equipment and receiver
- Connect the equipment into an outlet on a circuit different from that to which the receiver is connected
- Consult the dealer or an experienced radio/TV technician for help

Changes or modifications to this unit not expressly approved by the party responsible for compliance could void the user's authority to operate this equipment.

5.3 Other Countries Legislation

<p>Thailand</p>	<div style="border: 1px solid black; padding: 10px;"> <p style="text-align: center;">เครื่องโทรคมนาคมและอุปกรณ์นี้มีความสอดคล้องตามมาตรฐานหรือข้อกำหนดทางเทคนิคของ กสทช.</p> <div style="text-align: center;">  <p>nans.</p> </div> <p>เครื่องวิทยุคมนาคมนี้ ได้รับยกเว้น ไม่ต้องได้รับใบอนุญาตให้มี ใช้ซึ่งเครื่องวิทยุคมนาคมหรือตั้งสถานีวิทยุคมนาคมตามประกาศ กสทช. เรื่อง เครื่องวิทยุคมนาคม และสถานีวิทยุคมนาคมที่ได้รับยกเว้นไม่ต้องได้รับใบอนุญาตวิทยุคมนาคมตามพระราชบัญญัติวิทยุคมนาคม พ.ศ. 2498</p> <div style="display: flex; justify-content: space-between; align-items: center;">  <div style="text-align: right;"> <p>nans. โทรคมนาคม</p> <p>กำกับดูแลเพื่อประชาชน</p> <p>Call Center 1200 (InSW5)</p> </div> </div> </div>
<p>Japan</p>	<p>本製品は、特定無線設備の技術基準適合証明を受けています。</p> <p>この装置は、クラスB機器です。この装置は、住宅環境で使用することを目的としていますが、この装置がラジオやテレビジョン受信機に近接して使用されると、受信障害を引き起こすことがあります。取扱説明書に従って正しい取り扱いをして下さい。VCCI-B</p> <p>本製品は、シールドネットワークケーブル(STP)を使用して接続してください。また適切に接地してください。</p> <p>本製品は電気通信事業者（移動通信会社、固定通信会社、インターネットプロバイダ等）の通信回線（公衆無線 LAN を含む）に直接接続することができません。本製品をインターネットに接続する場合は、必ずルータ等を経由し接続してください。</p>

5.4 General Instructions and Cautions

Please read this User Manual carefully before using the product. Follow all instructions and recommendations included herein.

Any use of the product that is in contradiction with the instructions provided herein may result in malfunction, damage or destruction of the product.

The manufacturer shall not be liable and responsible for any damage incurred as a result of a use of the product other than that included herein, namely undue application and disobedience of the recommendations and warnings in contradiction herewith.

Any use or connection of the product other than those included herein shall be considered undue and the manufacturer shall not be liable for any consequences arisen as a result of such misconduct.

Moreover, the manufacturer shall not be liable for any damage or destruction of the product incurred as a result of misplacement, incompetent installation and/or undue operation and use of the product in contradiction herewith.

The manufacturer assumes no responsibility for any malfunction, damage or destruction of the product caused by incompetent replacement of parts or due to the use of reproduction parts or components.

The manufacturer shall not be liable and responsible for any loss or damage incurred as a result of a natural disaster or any other unfavourable natural condition.

The manufacturer shall not be held liable for any damage of the product arising during the shipping thereof.

The manufacturer shall not make any warrant with regard to data loss or damage.

The manufacturer shall not be liable and responsible for any direct or indirect damage incurred as a result of a use of the product in contradiction herewith or a failure of the product due to a use in contradiction herewith.

All applicable legal regulations concerning the product installation and use as well as provisions of technical standards on electric installations have to be obeyed. The manufacturer shall not be liable and responsible for damage or destruction of the product or damage incurred by the consumer in case the product is used and handled contrary to the said regulations and provisions.

The consumer shall, at its own expense, obtain software protection of the product. The manufacturer shall not be held liable and responsible for any damage incurred as a result of the use of deficient or substandard security software.

The consumer shall, without delay, change the access password for the product after installation. The manufacturer shall not be held liable or responsible for any damage incurred by the consumer in connection with the use of the original password.

The manufacturer also assumes no responsibility for additional costs incurred by the consumer as a result of making calls using a line with an increased tariff.

Electric Waste and Used Battery Pack Handling



Do not place used electric devices and battery packs into municipal waste containers. An undue disposal thereof might impair the environment!

Deliver your expired electric appliances and battery packs removed from them to dedicated dumpsites or containers or give them back to the dealer or manufacturer for environmental-friendly disposal. The dealer or manufacturer shall take the product back free of charge and without requiring another purchase. Make sure that the devices to be disposed of are complete.

Do not throw battery packs into fire. Battery packs may not be taken into parts or short-circuited either.

