



2N[®] IP Video Kit

IP Intercom Module



Installation Manual

Version: 2.15

www.2n.cz

The 2N TELEKOMUNIKACE a.s. is a Czech manufacturer and supplier of telecommunications equipment.



The product family developed by 2N TELEKOMUNIKACE a.s. includes GSM gateways, private branch exchanges (PBX), and door and lift communicators. 2N TELEKOMUNIKACE a.s. has been ranked among the Czech top companies for years and represented a symbol of stability and prosperity on the telecommunications market for almost two decades. At present, we export our products into over 120 countries worldwide and have exclusive distributors on all continents.



2N[®] is a registered trademark of 2N TELEKOMUNIKACE a.s. Any product and/or other names mentioned herein are registered trademarks and/or trademarks or brands protected by law.



2N TELEKOMUNIKACE a.s. administers the FAQ database to help you quickly find information and to answer your questions about 2N products and services. On www.faq.2n.cz you can find information regarding products adjustment and instructions for optimum use and procedures „What to do if...“.



2N TELEKOMUNIKACE a.s. hereby declares that the 2N product complies with all basic requirements and other relevant provisions of the 1999/5/EC directive. For the full wording of the Declaration of Conformity see the CD-ROM (if enclosed) or our website at www.2n.cz.



The 2N TELEKOMUNIKACE a.s. is the holder of the ISO 9001:2009 certificate. All development, production and distribution processes of the company are managed by this standard and guarantee a high quality, technical level and professional aspect of all our products.

Content:

- 1. Product Overview
 - 1.1 Components and Associated Products
 - 1.2 Terms and Symbols
- 2. Description and Installation
 - 2.1 Before You Start
 - 2.2 Mechanical Installation
 - 2.3 Electric Installation
 - 2.3.1 Overvoltage Protection
 - 2.4 Extending Module Connection
 - 2.5 Configuration
 - 2.6 Downloads
- 3. Technical Parameters
- 4. Supplementary Information
 - 4.1 Troubleshooting
 - 4.2 Directives, Laws and Regulations
 - 4.3 General Instructions and Cautions

1. Product Overview

Here is what you can find in this section:

- 1.1 Components and Associated Products
- 1.2 Terms and Symbols

Basic Features

2N[®] IP Video Kit is a universal and reliable IP intercom module designed for integration in the third parties' equipment. It is provided with a number of useful functions that are not quite common in the devices of this category. Featuring the SIP standard support and compatibility with renowned IP exchange and telephone manufacturers, **2N[®] IP Video Kit** can make use of all VoIP services available on the market.

2N[®] IP Video Kit is equipped with two composite video inputs, and can support two analog cameras with PAL or NTSC standard. The intercom transcodes the analog signal to video stream in selected format, such as H.264, H.264, MJPEG etc.

2N[®] IP Video Kit is equipped with a 10W power amplifier for external loudspeaker connection. If the power output of the internal loudspeaker is insufficient for your specific application, you can connect an external loudspeaker to the line output. You can also connect an external electret microphone or another audio signal source to the IP intercom line output.

2N[®] IP Video Kit allows up to 16 separate buttons or a 16-button matrix keypad to be connected. Set the button function flexibly according to your specific application needs. You can set up to three telephone numbers and call time profiles to each of the buttons to make the called subscriber accessible any time. Configure the buttons as a numerical keypad, which can be used as a switch activation code lock or for dialling a preset or any other telephone number.

2N[®] IP Video Kit is equipped with one relay output and two active 12 V outputs. Use the numerical keypad or, during the call, any telephone to control these outputs. A wide range of output mode settings help you make use of a high number of applications. Device is also equipped with two galvanically isolated digital inputs and three status signalling outputs.

2N[®] IP Video Kit is very easy to install. All you have to do is connect it to your LAN using the LAN cable. An integrated one-port LAN switch simplifies installation on sites with a limited LAN infrastructure. Supply the intercom either from a 9–36 V source or directly from your POE supporting LAN.

Use a PC web browser to configure your **2N[®] IP Video Kit** . Apply the **2N[®] Access Commander** to administer extensive intercom installations easily and quickly.

Advantages of Use

- Industrial design and variable mounting options
- Wide supply power range + PoE supply
- Two analog cameras connection
- Integrated 10 W power amplifier
- External amplifier/microphone/audio signal source connection
- Galvanically isolated relay output
- Two controlled active 12 V outputs
- Two galvanically isolated logic inputs
- Up to 3 signalling LED outputs
- Up to 16 external buttons/matrix keypad connection
- Integrated one-port LAN switch
- Bidirectional communication – acoustic echo cancelling
- Configuration via web interface/special PC application
- SIP 2.0 support
- Video codecs (H.263, H.263+, H.264, MPEG-4, MJPEG)
- Audio codecs (G.711, G.729, G.722, L16/16 kHz)
- HTTP(S) server for configuration
- SNTP client for server time synchronisation
- RTSP server for audio streaming
- TFTP client for automatic configuration and firmware update

1.1 Components and Associated Products

Basic Units

Part No. 9154100C



- Intercom module in plastic box

Part No. 9154101C



- Intercom module without box

Internal Units and Accessories

<p>Part Numbers:</p> <p>2N Part No. 91378375</p> <p>Axis Part No. 01668-001</p> <p>2N Part No. 91378376</p> <p>Axis Part No. 01670-001</p> 	<ul style="list-style-type: none"> • 2N[®] Indoor Touch 2.0 – black • WiFi version (second part no.) • The elegant internal touch panel, 2N[®] Indoor Touch 2.0, is suitable for all 2N IP intercoms. On the panel's display not only can you find out who is at the door, but also start a conversation with the visitor, open the lock or turn on the light in the entrance hall.
<p>2N Part. No. 91378382</p> <p>Axis Part No. 01425-001</p> 	<ul style="list-style-type: none"> • 2N[®] Indoor Touch desk stand black
<p>Part Numbers:</p> <p>2N Part No. 91378375WH</p> <p>Axis Part No. 01669-001</p> <p>2N Part No. 91378376WH</p> <p>Axis Part No. 01671-001</p> 	<ul style="list-style-type: none"> • 2N[®] Indoor Touch 2.0 – white • WiFi version (second part no.) • The elegant internal touch panel, 2N[®] Indoor Touch 2.0, is suitable for all 2N IP intercoms. On the panel's display not only can you find out who is at the door, but also start a conversation with the visitor, open the lock or turn on the light in the entrance hall.

<p>2N Part. No. 91378382W Axis Part No. 01426-001</p> 	<ul style="list-style-type: none">• 2N[®] Indoor Touch desk stand white
---	--

VoIP Telephones

2N Part No. 91378357

Axis Part No. 01422-001



- Grandstream GXV3240 VoIP video telephone
- GXV3240 is the successor to the popular GXV3140 model, which allows comfortable video calls in the IP network. Touchscreen and keyboard control.



2N Part No. 91378358



Axis Part No. 01421-001



- Grandstream GXV3275 VoIP telephone
- GXV3275 is the successor to the popular GXV3175 model, which allows comfortable video calls in the IP network. Touchscreen control.

Electric Locks

<p>Part No. 932071E</p> 	<ul style="list-style-type: none">• BEFO 11211• 12 V / 230 mA DC• low consumption
<p>Part No. 932081E</p> 	<ul style="list-style-type: none">• BEFO 11221 with momentum pin• 12 V / 230 mA DC• low consumption• For opening of the lock a short electrical impuls is sufficient, which unlocks the lock. Lock is then open until someone closes the door.
<p>Part No. 932091E</p> 	<ul style="list-style-type: none">• BEFO 11211MB with mechanical blocking• 12 V / 230 mA DC• low consumption• Enables mechanically close or open the lock. When opened, the lock is open all the time. When closed, it behaves as standart electrical lock.

<p>Part No. 932061E</p> 	<ul style="list-style-type: none">• BEFO 211211 door signalling, low consumption• 12 V / 230 mA• A regular lock with a built-in contact to indicate whether the door is open or closed.
<p>Part No. 932072E</p> 	<ul style="list-style-type: none">• BEFO 31211• fail-safe• 12 V / 170 mA DC• The failsafe lock is closed when electricity is switched on. When electricity is interrupted, the lock is opened.
<p>Part No. 932062E</p> 	<ul style="list-style-type: none">• BEFO 321211• fail-safe, door signalling• 12 V / 170 mA• The failsafe lock is closed when electricity is switched on. When electricity is interrupted, the lock is opened.• It contains a built-in contact to indicate whether the door is open or closed.

 **Tip**

- [FAQ: Electric locks - Difference between locks in 2N IP intercoms accessories](#)



Power Supply

<p>Part Numbers:</p> <p>2N Part No. 91378100E</p> <p>2N Part No 91378100US</p> <p>Axis Part No. 01403-001</p> 	<ul style="list-style-type: none"> • PoE injektor - with EU cable • PoE injector - with US cable • For power supply of intercom via ethernet cable when PoE switch is not available.
<p>Part No. 91341481E</p> 	<ul style="list-style-type: none"> • Stabilised 12 V / 2 A power supply needs to be used when no PoE is available.
<p>Part No. 932928</p> 	<ul style="list-style-type: none"> • 12 V transformer • For 230 V mains voltage. • For external power supply of the lock with 12 V AC voltage.

Additional Modules

<p>2N Part No. 9159010</p> <p>Axis Part No. 01386-001</p> 	<ul style="list-style-type: none"> • Security Relay • A handy add-on that significantly enhances door entry security as it prevents tampering with the intercom and forced opening of the lock. To be installed between intercom and lock, powered by the intercom.
<p>2N Part No. 9137410E</p> <p>Axis Part No. 01397-001</p> 	<ul style="list-style-type: none"> • External IP Relay - 1 output • Standalone IP device which can be controlled by HTTP commands sent by 2N IP intercom, which can thus control devices on unlimited distance.
<p>2N Part No. 9137411E</p> <p>Axis Part No. 01398-001</p> 	<ul style="list-style-type: none"> • External IP Relay - 4 outputs, PoE • Standalone IP device which can be controlled by HTTP commands sent by 2N IP intercom, which can thus control devices on unlimited distance.

<p>Part No. 9159013</p> 	<ul style="list-style-type: none"> • Exit button • A button for connection to a logic input for opening a door inside a building.
<p>2N Part No. 9159012</p> <p>Axis Part No. 01388-001</p> 	<ul style="list-style-type: none"> • Magnetic door contact • Set for installation on a door, enabling the status of door opening to be ascertained. Used when the intercom is used for door protection, to detect when the door is not closed or forced open.
<p>Part No. 9159014EU/UK</p> <p>Part No. 9159014US</p> <p>Axis Part No. 01404-001</p> 	<ul style="list-style-type: none"> • 2N[®] 2Wire • (set of 2 adaptors and power source for EU/US/UK) • The 2N[®] 2Wire converter allows you to use existing wiring (2 wires) from your original door bell or door intercom to connect any IP device. You don't have to configure anything, and you only need one 2N[®] 2Wire unit at each end of the cable and a power source connected to at least one of these units. <p>The 2N[®] 2Wire unit then provides PoE power not only to the second converter, but also to all other connected IP end devices.</p>

<p>Part No. 9154001</p> 	<ul style="list-style-type: none"> • Electret microphone with self-adhesive layer. • Sensitivity 42 dB, operating temperature 5–35 °C. Adhesion surface 25 (W) x 25 (H) x 16 (D) mm. Cable length 2.9 m. Must be protected from water penetration.
<p>Part No. 9154002</p> 	<ul style="list-style-type: none"> • Speaker with self-adhesive layer. • External dimensions 60 (W) x 60 (H) x 14 (D) mm, actual speaker diameter 45 mm. Cable length 1.4 m. Must be protected from water penetration. <ul style="list-style-type: none"> • Impedance: 16 ohm +/- 15% • Power: 1 W
<p>Part No. 9154003</p> 	<ul style="list-style-type: none"> • Analogue camera for connection to the OEM intercom 2N[®] IP Video Kit. • External dimensions 32 x 32 mm • Resolution: 420 TV rows • Sensitivity: 3 lux • Camera turning option: horizontally and vertically in the range of $\pm 8^\circ$ • Camera chip: colour, 1/4" CCD, automatic transition to black&white mode at dark • Pinhole type: f = 3.7mm • Camera angle of view: 60° diagonally

<p>2N Part No. 9154004 Axis Part No. 01479-001</p> 	<ul style="list-style-type: none">• Water-proof metal buton• Hole diameter 19 mm, button diameter 22 mm.
--	---

License

2N Part No. 9137905 Axis Part No. 01376-001	<ul style="list-style-type: none">• Enhanced Audio
2N Part No. 9137906 Axis Part No. 01377-001	<ul style="list-style-type: none">• Enhanced Video
2N Part No. 9137907 Axis Part No. 01378-001	<ul style="list-style-type: none">• Enhanced Integration
2N Part No. 9137908 Axis Part No. 01379-001	<ul style="list-style-type: none">• Enhanced Security
2N Part No. 9137909 Axis Part No. 01380-001	<ul style="list-style-type: none">• Gold
2N Part No. 9137910 Axis Part No. 01381-001	<ul style="list-style-type: none">• InformaCast
2N Part No. 9137915 Axis Part No. 01382-001	<ul style="list-style-type: none">• NFC

 **Tip**

- Refer to the Configuration Manual for 2N IP intercoms, Subs. **3.2 Function Licensing** for details.

 **Tip**

- For more accessories and particular advice please contact your local distributor of 2N products.

1.2 Terms and Symbols

The following symbols and pictograms are used in the manual:

Safety

- Always abide by this information to prevent persons from injury.

Warning

- Always abide by this information to prevent damage to the device.

Caution

- Important information for system functionality.

Tip

- Useful information for quick and efficient functionality.

Note

- Routines or advice for efficient use of the device.

2. Description and Installation

Here is what you can find in this section:

- 2.1 Before You Start
- 2.2 Mechanical Installation
- 2.3 Electric Installation
- 2.4 Extending Module Connection
- 2.5 Configuration
- 2.6 Downloads

2.1 Before You Start

Product Completeness Check

Before installing this product, please check whether the 2N[®] IP Video Kit delivery complies with the following packing list.

- 1x 2N[®] IP Video Kit
- 1x Short Installation Manual

2.2 Mechanical Installation

Mounting Types

Refer to the table below for a list of mounting types and necessary components. Make sure that the installation site is not exposed to flowing or condensed water.

Wall mounting

Use the proper wall mounting screws and dowels (not included in the delivery). Hang the device on the wall using the cover bottom holes.

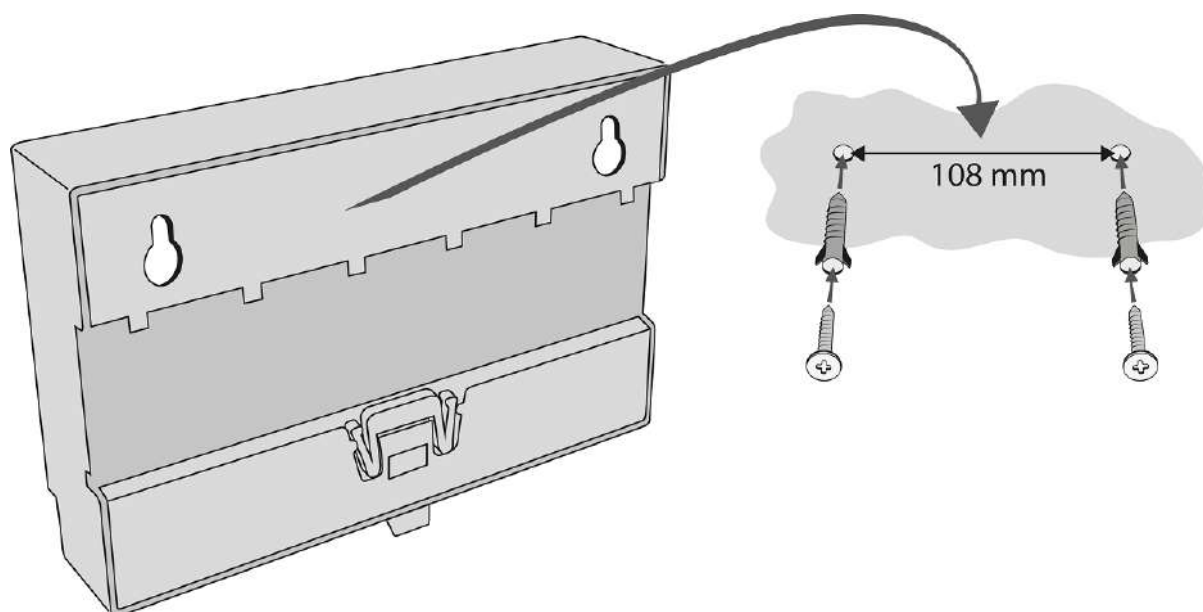

DIN rail mounting

Mount the device to a standard TS 35 DIN rail. The recommended minimum DIN rail length is 14 cm.

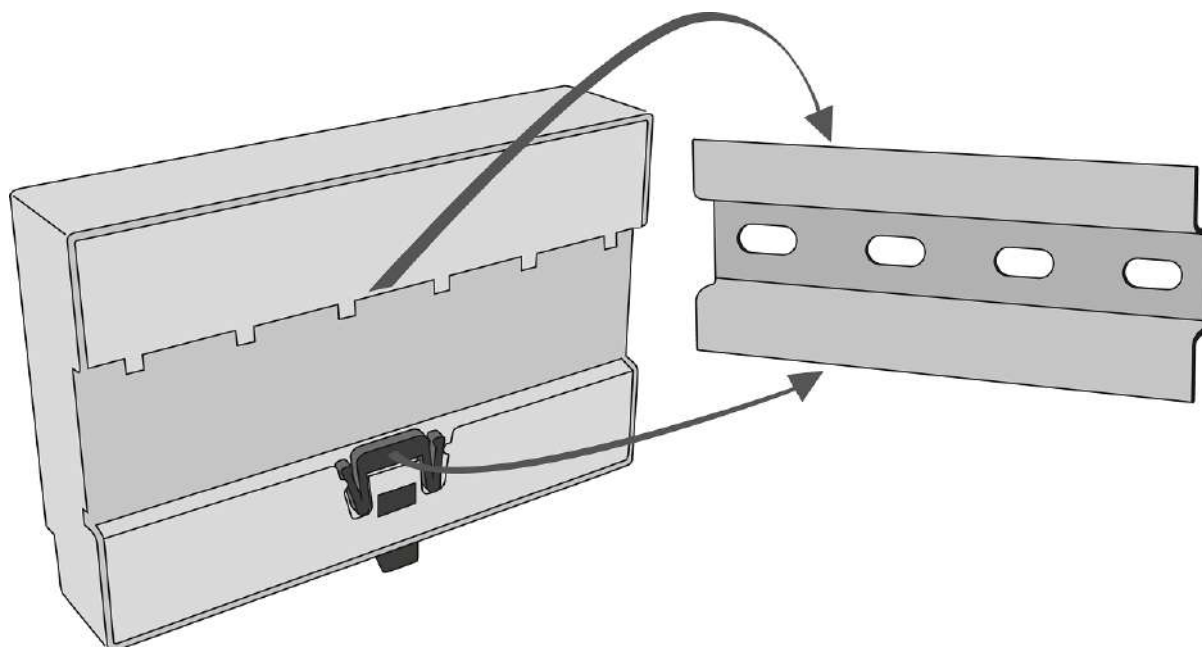

PCB mounting (for Part No. 9154101 only)

Use 4-6 distance columns and proper screws (not included in the delivery) to mount the PCB to the support. Fix the distance columns as shown in the figure.

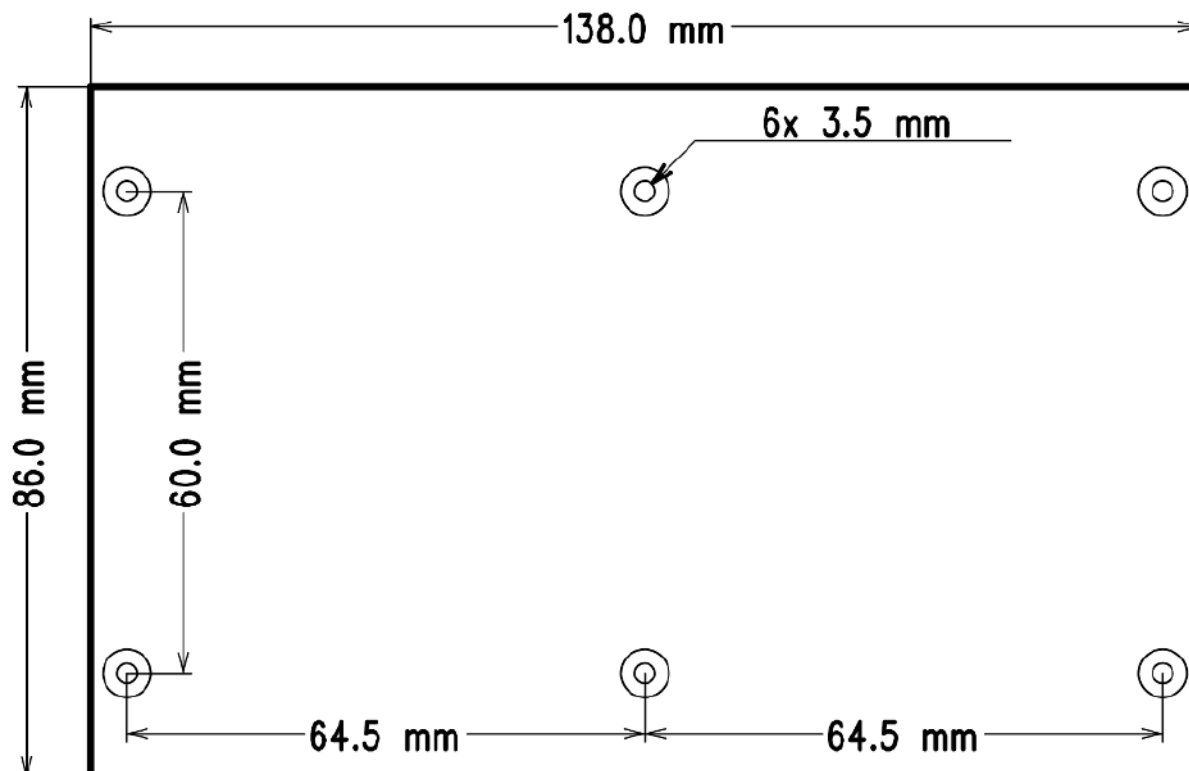

 **Caution**

- Before starting the mechanical installation on a selected place, make sure carefully that the preparations connected with it (drilling, wall cutting) cannot damage the electrical, gas, water and other existing wires and pipes.
- The warranty does not apply to the product defects and failures arisen as a result of improper mounting (in contradiction herewith). The manufacturer is neither liable for damage caused by theft within an area that is accessible after the attached electric lock is switched. The product is not designed as a burglar protection device except when used in combination with a standard lock, which has the security function.
- When the proper mounting instructions are not met, water might get in and destroy the electronics. It is because the intercom circuits are under continuous voltage and water infiltration causes an electro-chemical reaction. The manufacturer's warranty shall be void for products damaged in this way!
- To avoid injury due to accidental drop of the equipment, do not mount it higher than 2 meters.

2.3 Electric Installation

This subsection describes how to connect the 2N[®] IP Audio Kit into your Local Area Network (LAN) and how to connect supply voltage and other electric interfaces.

⚠ Caution

- The device must be part of the electrical system of the building.

Device and PCB Connectors

Figures below show the layout of the 2N[®] IP Video Kit connectors and terminals.

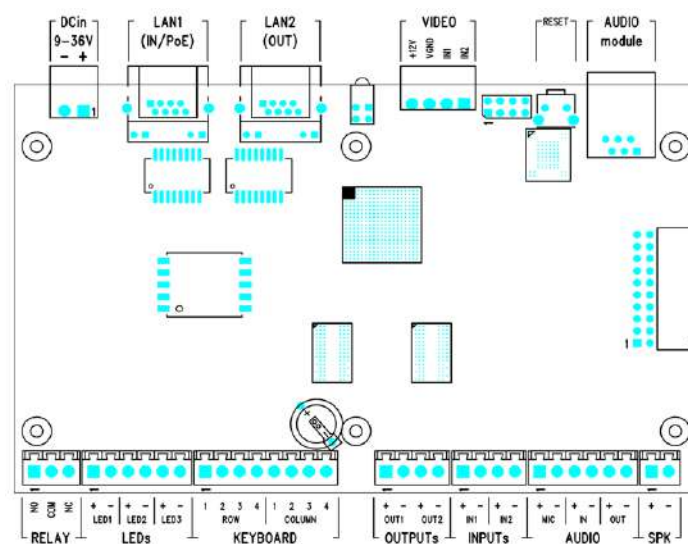

PCB Connectors

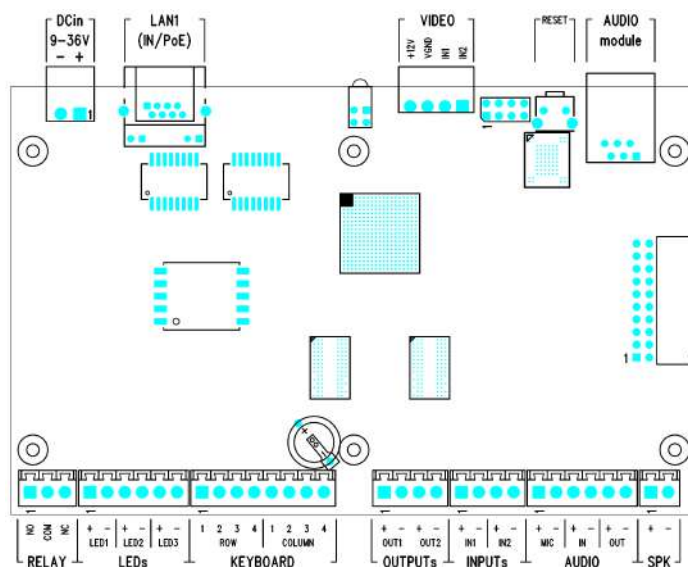

568v2 PCB Connectors

Group	Terminals	Function
DC in		9–36 V / 1.5 A power input
LAN1		LAN connection with PoE function
D1		Integrated red and green LED indicators
VIDEO	+12 V, VGND, IN1, IN2	Connection of up to two analog cameras connected via composite PAL or NTSC signal
RESET		RESET multifunction button
AUDIO MODULE		Connection of an audio module with microphone, loudspeaker, buttons and LEDs
RELAY	NO, COM, NC	Programmable relay switch with an accessible N/O and N/C contact. Used for connection of non-critical devices only (lights, e.g.).
LEDs	LED1+, LED1– LED2+, LED2–	3 current outputs for connection of programmable LED indicators; two terminals per LED

Group	Terminals	Function
KEYBOARD	COL1-4 ROW1-4	Connection of matrix keypad (4 x 4) or 16 separate buttons
OUTPUTS	OUT1+, OUT1- OUT2+, OUT2-	2 programmable active 12 V DC/ 600 mA outputs
INPUTs	IN1+, IN1- IN2+, IN2-	2 programmable galvanically isolated inputs
AUDIO	MIC+, MIC- IN+, IN- OUT+, OUT-	Microphone input, line input, line output
SPEAKER	SPK+ SPK-	Power amplifier output for loudspeaker

Connection to LAN

Connect **2N[®] IP Video Kit** to the LAN using an RJ-45 terminated UTP/STP cable (of category Cat 5e or higher). As the device is equipped with the Auto-MDIX function, you can use either the straight or crossed cable version.

2N[®] IP Video Kit is equipped with LAN interface (LAN1) and an integrated Ethernet switch. You can use only LAN1 interfaces for LAN connection. LAN1 is the only interface provided with PoE. LAN2 helps connect another LAN device on the installation site. This interface is not equipped with PoE. (This applies only to HW revision 568v1).

Note

- 2N[®] IP Video Kit does not allow you to feed another connected device via PoE. The integrated PoE function is intended for the 2N[®] IP Video Kit supply only.

Caution

- We recommend the use of a LAN surge protection.
- We recommend the use of a shielded SSTP Ethernet cable.

Connection of External Power Supply

2N[®] IP Video Kit can be supplied either from an external 9–36 V / 2 A DC source or directly from the LAN provided with the PoE 802.3af supporting network elements.

External Power Supply

Connect the external 12V power supply to the DC in terminals. Use safety low-voltage voltage (SELV, 9–36 V) dimensioned for the minimum current consumption of 1.5 A (Part No. 91341481E, e.g.) to make your device work correctly.

PoE Supply

2N[®] IP Video Kit is compatible with the PoE 802.3af technology (Class 0 - 12.95 W) and can be supplied directly from the LAN via compatible network elements. If your LAN lacks such compatible elements, you can insert a PoE injector, Part No. 91758100E, between your 2N[®] IP Video Kit and the nearest network element. Connect your 2N[®] IP Video Kit to the LAN via the LAN1 interface to supply it successfully.

 **Caution**

- In case you feed your **2N[®] IP Video Kit** via PoE or from a limited-power external power supply, monitor the power consumption of the whole system. With regard to the PoE 802.3af capacities and efficiency of the switched-mode power supplies in the device, the maximum possible device input is approximately 12 W. An overload of the PoE source usually results in PoE disconnection and, subsequently, **2N[®] IP Video Kit** restart.
- The **2N[®] IP Video Kit** consumption at relax (power amplifier inactive, no load switched on LED1-3 and OUT1-2 outputs) is up to 2 W.
- The maximum power amplifier consumption is determined by the current loudspeaker volume level and impedance (up to 10 W for a 4 Ω loudspeaker). The real consumption is typically lower and depends on the characteristics of the signal to be amplified.
- If you intend to connect a considerable load to the OUT1 and OUT2 outputs, make sure that the total input does not exceed the above mentioned limit (12 W for PoE). If the PoE supply fails to provide sufficient power for the specific application, use a more powerful external source to make your device work perfectly.

Connection of LED Indicators

2N[®] IP Video Kit is equipped with three independent current LED control outputs (LED1+, LED2+ and LED3± terminals). All of them are current outputs (20 mA, up to 12 V). LEDs with $I_F \geq 20$ mA can be connected directly, in the opposite case a ballast resistor with resistance $R = (12 - U_F) / I_F$ is necessary. Mind the polarity while connecting the LEDs to make your device work properly.

The functions of the LED1, LED2 and LED3 outputs are programmable.

Connection of Keypad/Buttons

2N[®] IP Video Kit is equipped with an interface for connection of an external matrix keypad or up to 16 separate buttons; see the figure below:

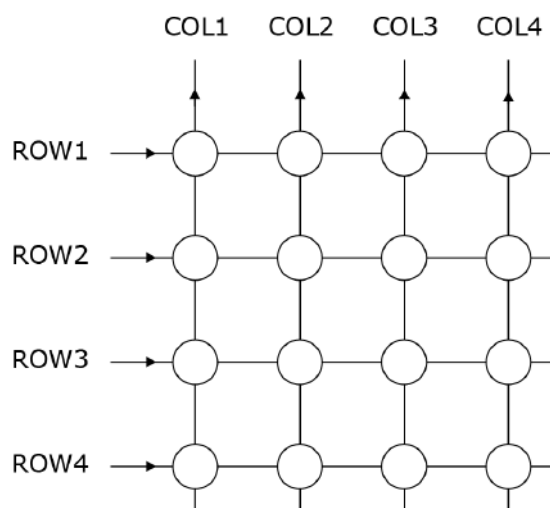

The buttons are connected in a 4x4 matrix to the ROW1-4 (output) and COL1-4 (inputs) terminals. If you do not make use of all of the 16 buttons, you can leave some of the ROW and COL signals unconnected. If you need one button only, connect it to the ROW1 and COL4 terminals.

The button function is programmable. You can set the numerical keypad buttons to any matrix position (0 to 9, *, #) or configure one of the 16 buttons for dialling a telephone directory position.

Caution

- Errors such as false keystroke detection may occur in installations with strong EMI. Therefore, make sure that the keypad or button cables are carried in a trunk separated from the power cables and are as short as possible (up to 1 m).

Connection of External Loudspeaker

2N[®] IP Video Kit is equipped with an integrated 10 W power amplifier of class D. The amplifier output is available on the SPEAKER+ and SPEAKER- terminals. The maximum power is achievable with a 4 Ω loudspeaker only. The higher the loudspeaker impedance, the lower the maximum power output; refer to the table below:

Loudspeaker impedance	Maximum power (at +20 dB)
4 Ω (min)	10 W
8 Ω	5 W
16 Ω	2.5 W
32 Ω	1.2 W
64 Ω	0.6 W

Caution

- Never connect a loudspeaker with impedance lower than 4 Ω to avoid system damage.
- Never exceed the maximum power output designated for the loudspeaker to avoid loudspeaker destruction. Choose a loudspeaker with proper impedance and maximum power values, or limit the maximum volume level in the device configuration.
- Use an external power supply to maximise the power output. Make sure that the maximum Master volume value is +6 dB in the Hardware / Audio menu if you use PoE and 4 Ω speaker.

Connection of External Microphone

2N[®] IP Video Kit is equipped with an input for connection of an external electret microphone on the MIC+ and MIC- terminals. Shielding of the shielded cable is connected to the IN- terminal.

Caution

- Undesired noise may be heard in the earphone where EMI affects the microphone signal. To avoid this, connect the microphone using a shielded cable of the minimum possible length.

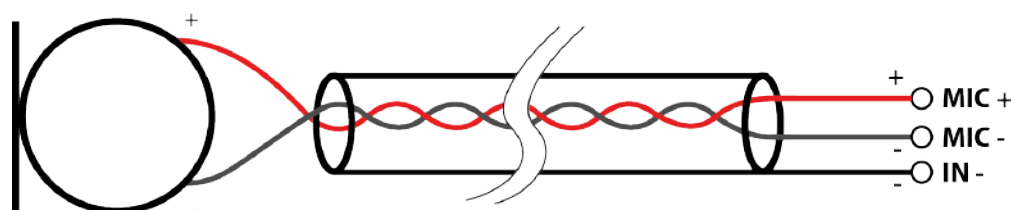

Connection of External Amplifier

2N[®] IP Video Kit is equipped with a line output for connection of an external power amplifier on the LINE OUT+ and LINE OUT- terminals.

Connection of External Audio Source

2N[®] IP Video Kit is equipped with a line input for connection of an external audio signal source (FM tuner, MP3 player, e.g.) on the LINE IN+ and LINE IN- terminals.

Connection to Relay Output

is equipped with one galvanically isolated relay switch with N/O and N/C contacts on the NC, NO and COM terminals. The relay function is programmable.



- Output wiring diagram for Relay terminals

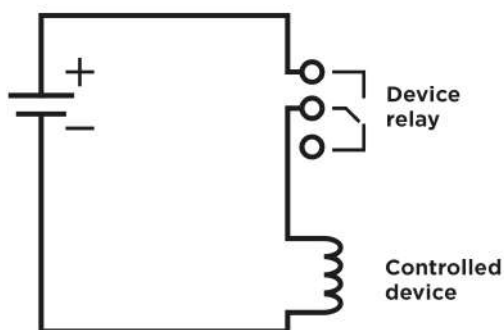

Wiring diagram for the controlled device's electric circuit closing

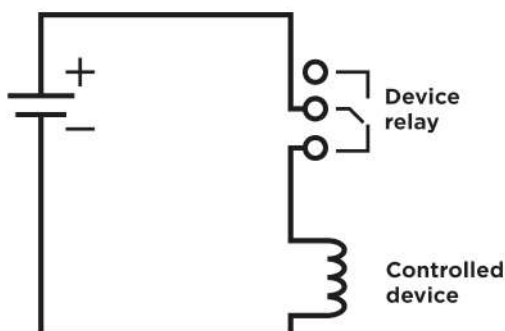

Wiring diagram for the controlled device's electric circuit opening

Warning

- Do not exceed the voltage and current limits for the load connected to the relay contacts as specified in the technical parameters of the device to avoid device damage.

Connection to Digital Outputs

2N[®] IP Video Kit is equipped with two active 12 V / 600 mA outputs on the OUT1± and OUT2± terminals. The outputs are overload and short-circuit resistant.

Warning

When you connect a device containing a coil, such as a relay or an electromagnetic lock, it is necessary to protect the intercom against voltage peak while switching off the induction load. For this way of protection we recommend a diode 1 A / 1000 V (e.g., 1N4007, 1N5407, 1N5408) connected antiparallel to the device.

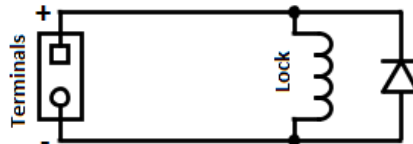
**Reset Button**

Located among the main unit connectors, the Reset button helps you reset the factory default values, restart the device, find the device IP address and switch the static /dynamic mode.

IP Address Finding

Follow the instructions below to **identify the current IP address**:

- Press and hold the RESET button.
- Wait until the red and green LEDs go on simultaneously on the device and the acoustic signal  can be heard (approx. 15–35 s).

- Release the RESET button.
- The device automatically announces the current IP address.

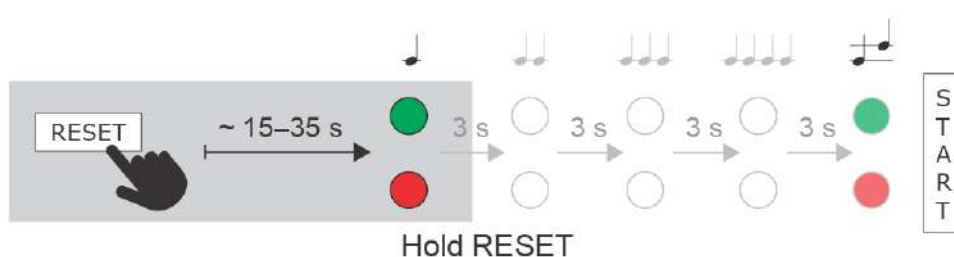



Note

- The delay after pressing RESET till the first light and sound signalling is set to 15–35 s depending on the 2N IP intercom/answering unit model used.
 - 18 s is the valid value for 2N[®] IP Video Kit.

Static IP Address Setting

Follow the instructions below to switch on the **Static IP address** mode (DHCP OFF):

- Press and hold the RESET button.
- Wait until the red and green LEDs go on simultaneously on the device and the acoustic signal  can be heard (approx. 15–35 s).
- Wait until the red LED goes off and the acoustic signal  can be heard (approx. for another 3 s).
- Release the RESET button.

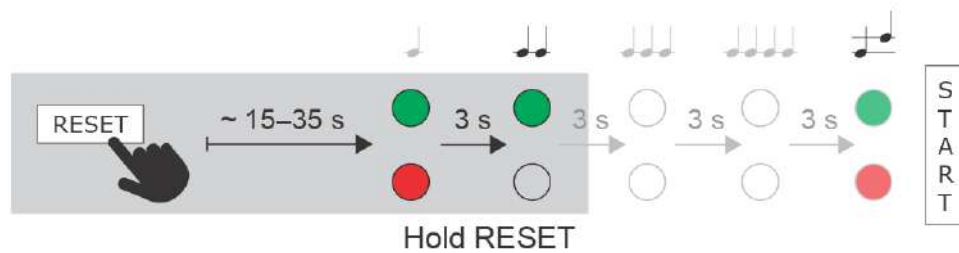

The following network parameters will be set after restart:

- IP address: 192.168.1.100
- Network mask: 255.255.255.0
- Default gateway: 192.168.1.1



Dynamic IP Address Setting

Follow the instructions below to switch on the **Dynamic IP address** mode (DCHP ON):

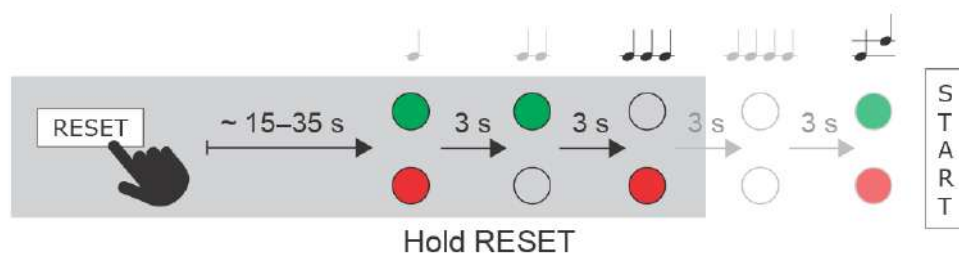

- Press and hold the RESET button.
- Wait until the red and green LEDs go on simultaneously on the device and the acoustic signal  can be heard (approx. 15-35 s).
- Wait until the red LED goes off and the acoustic signal  can be heard (approx. for another 3 s).
- Wait until the green LED goes off and the red LED goes on again and the acoustic signal  can be heard (approx. for another 3 s).
- Release the RESET button.



Factory Reset

Follow the instructions below to **reset the factory default values**:

- Press and hold the RESET button.
- Wait until the red and green LEDs go on simultaneously and the acoustic signal  can be heard (approx. 15-35 s).

- Wait until the red LED goes off and the acoustic signal  can be heard (approx. for another 3 s).
- Wait until the green LED goes off and the red LED goes on again and the acoustic signal  can be heard (approx. for another 3 s).
- Wait until the red LED goes off and the acoustic signal  can be heard (approx. for another 3 s).
- Release the RESET button.

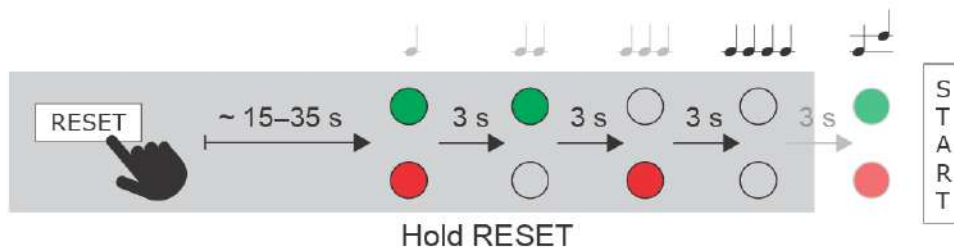

Caution

- In case of resetting the factory default settings on a device with a version of firmware 2.18 or higher it is necessary to reprogram the 2N[®] Security Relay using the instructions from section 2.4.

Device Restart

Press the RESET button shortly (< 1 s) to restart the system without changing configuration.

Note

- The time interval between the short press of RESET and reconnection after restart is 22 s for 2N[®] IP Video Kit.

Connection to Digital Inputs

2N[®] IP Video Kit is equipped with two digital inputs on the IN1± and IN2± terminals. The digital inputs recognise the following two logic levels: log. 0 for voltage under 1.1 V a log. 1 for voltage over 3 V. Keep the voltage polarity to make the function work properly. The function is programmable for either input.

Camera connection

2N[®] IP Video Kit is equipped with two video inputs for analog camera with composite PAL or NTSC signal. Output from camera connects to VIDEO VGND and VIDEO IN1 /IN2 sockets. 2N[®] IP Video Kit automatically detects signal format. If the attached camera has no own power supply, it can be supplied from 2N[®] IP Video Kit from VIDEO +12 V and VIDEO VGND sockets.

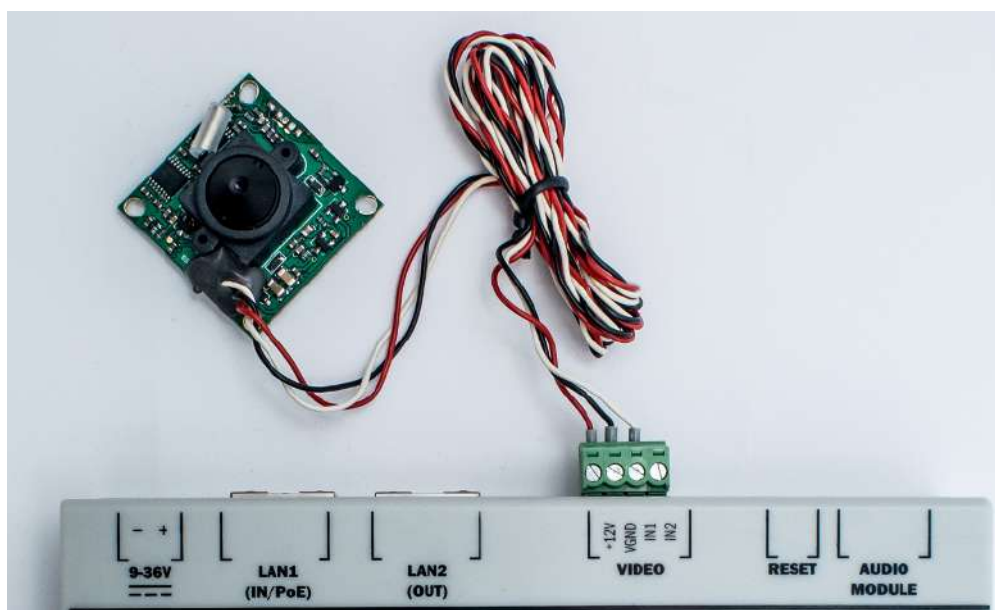

2.3.1 Overvoltage Protection

Recommendations for Additional Overvoltage Protection Installation

If running:

- a) outside a building,
- b) on/in an outer wall or roof,

the 2N device wiring may be exposed to atmospheric effects resulting in overvoltage that may subsequently damage any devices installed outside the building, on its outer wall or roof. Overvoltage may damage devices connected to these wires and installed inside the building as well. Therefore, we recommend that additional surge protectors be installed on all the wires leading outside buildings, on outer walls or roofs, namely:

- a) as close as possible to the device installed outside the building or on its outer wall /roof,
- b) as close as possible to the point where the wires leave the building.

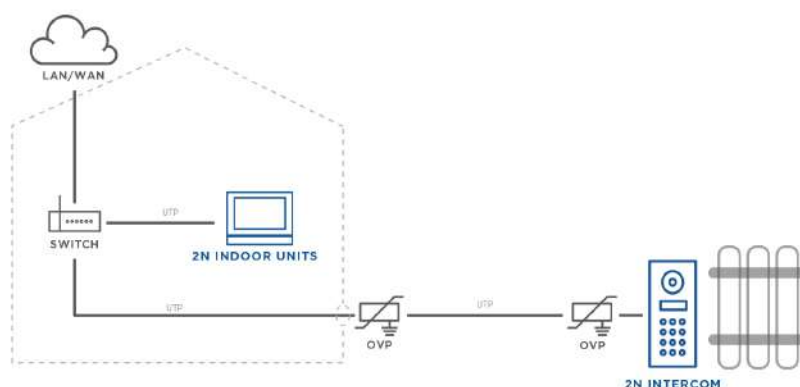
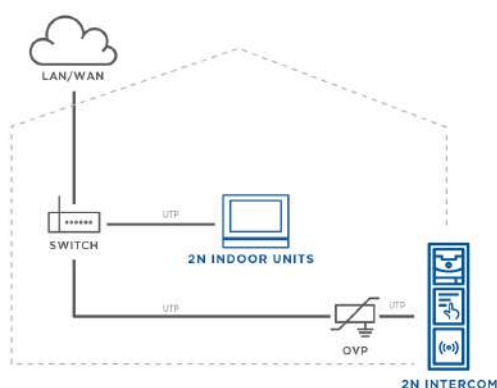

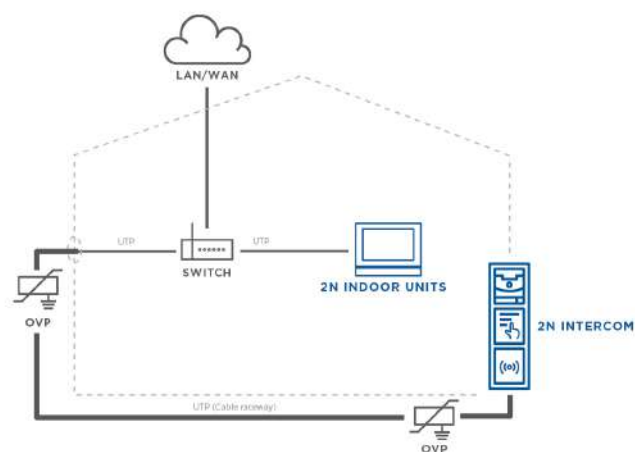

OVP = overvoltage protection

2.4 Extending Module Connection

2N[®] IP Video Kit allows to connect following extending modules:

- Security Relay

Security Relay

The 2N[®] Security Relay (Part No. 9159010) is used for enhancing security between the intercom and the connected electric lock. The 2N[®] Security Relay is designed for any 2N IP intercom model with firmware versions 1.15 and higher. It significantly enhances security of the connected electric lock as it prevents lock opening by forced intercom tampering.



Function:

The 2N[®] Security Relay is a device installed between an intercom (outside the secured area) and the electric lock (inside the secured area). The 2N[®] Security Relay includes a relay that can only be activated if the valid opening code is received from the intercom.

Specifications:

Passive switch: NO and NC contacts, up to 30 V / 1 A AC/DC

Switched output:

- Where the security relay is fed from the intercom, 9 to 13 V DC is available on the output depending on the power supply (PoE: 9 V; adapter: source voltage of minus 1 V) / 400 mA DC.
- Where the security relay is fed from an external power supply, 12 V / 700 mA DC is available on the output.

Dimensions: (56 x 31 x 24) mm

Weight: 20 g

Installation:

Install the 2N[®] Security Relay onto a two-wire cable between the intercom and the electric lock inside the area to be secured (typically behind the door). The device is powered and controlled via this two-wire cable and so can be added to an existing installation. Thanks to its compact dimensions, the device can be installed into a standard mounting box.

Connection:

Connect the 2N[®] Security Relay to the intercom as follows:

- To the intercom active output (OUT1 or OUT2)

Connect the electric lock to the 2N[®] Security Relay output as follows:

- To the switched output.
- To the passive output in series with the external power supply.

The device also supports a Departure button connected between the 'PB' and '- HeliosIP/IP Intercom' terminals. Press the Departure button to activate the output for 5 seconds.

Status signalling:

Green LED	Red LED	Status
blinking	off	Operational mode
on	off	Activated output
blinking	blinking	Programming mode - waiting for initialisation
on	blinking	Error - wrong code received

Configuration:

- Connect the 2N[®] Security Relay to the properly set intercom switch output; refer to the **Configuration Manual for 2N IP intercoms**. Make sure that one LED at least on the 2N[®] Security Relay is on or blinking.
- Press and hold the 2N[®] Security Relay Reset button for 5 seconds to put the device in the programming mode (both the red and green LEDs are blinking).
- Activate the intercom switch using the keypad, telephone, etc. The first code sent from the intercom will be stored in the memory and considered valid. After code initialisation, the 2N[®] Security Relay will pass into the operational mode (the green LED is blinking).

Caution

- In case of resetting the factory default settings on a device with a version of firmware 2.18 or higher it is necessary to reprogram the 2N[®] Security Relay using the instructions above.

Tip

- [FAQ: 2N[®] Security Relay - what it is and how to use it with 2N IP intercom?](#)

Connection:

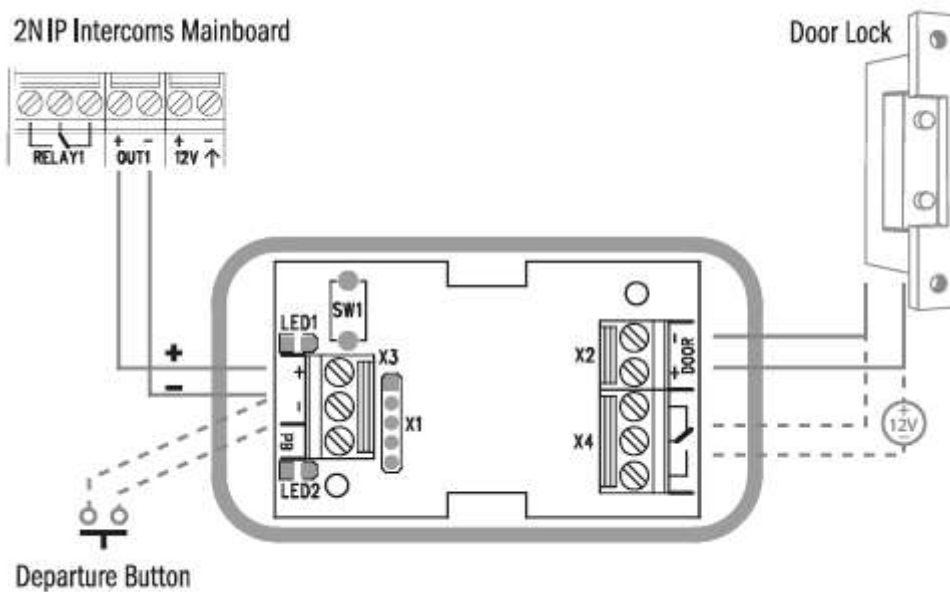

2.5 Configuration

Device Configuration

Configure 2N[®] IP Video Kit using a PC equipped any web browser as follows:

- Launch your web browser (Internet Explorer, Firefox, etc.).
- Enter the IP address of your intercom (<http://192.168.1.100/>, e.g.).
- Log in with username **Admin** and password **2n**.

You have to know the IP address of your device to log in to the integrated web server.

Upon purchase, 2N[®] IP Video Kit is in the Dynamic IP address mode, i.e. it obtains the IP address automatically if there is an adequately set DHCP server in the LAN. If no such server is available, set the Static IP address mode to your 2N[®] IP Video Kit.

If the device remains inaccessible (you have forgotten the IP address or the LAN configuration has changed, e.g.), change the network settings using the RESET button on the device.

LAN Setting Change and Default Reset

2N[®] IP Video Kit is equipped with a RESET button. Press the button shortly (< 1 s) to restart the system without changing configuration.

Follow the instructions below to **identify the current IP address**:

- Connect the loudspeaker to the SPEAKER terminals.
- Press and hold the REST button.
- Wait until the red and green LEDs on the device come on simultaneously (approx. 15 s).
- Release the RESET button.
- The device announces the current IP address via the loudspeaker connected automatically.

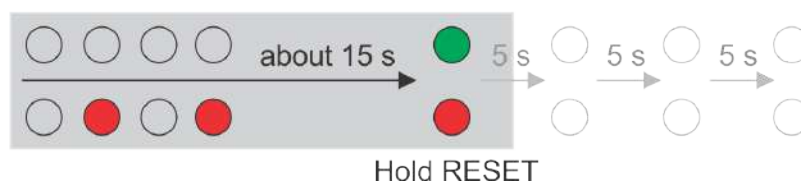

Follow the instructions below to switch on the **Static IP address** mode (DHCP OFF):

- Press and hold the RESET button.
- Wait until the red and green LEDs on the device come on simultaneously (approx. 15 s).
- Wait until the red LED goes off (approx. 5 s).
- Release the RESET button.

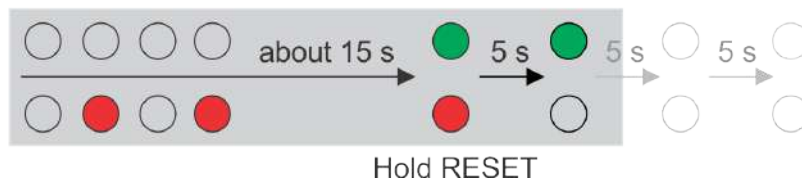

The following network parameters will be set after restart:

- IP address: 192.168.1.100
- Network mask: 255.255.255.0
- Default gateway: 192.168.1.1

Follow the instructions below to switch on the **Dynamic IP address** mode (DCHP ON):

- Press and hold the RESET button.
- Wait until the red and green LEDs on the device come on simultaneously (approx. 15 s).
- Wait until the red LED goes off (approx. 5 s).
- Wait until the green LED goes off and the red LED comes on again (another 5 s).
- Release the RESET button.

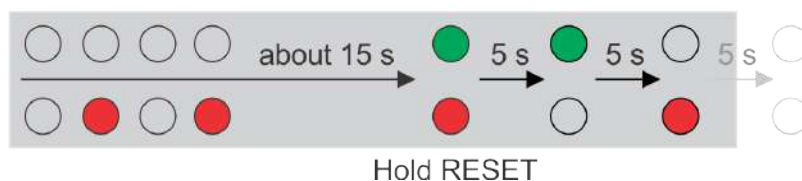

Follow the instructions below to **reset the factory default values**:

- Press and hold the RESET button.
- Wait until the red and green LEDs on the device come on simultaneously (approx. 15 s).
- Wait until the red LED goes off (approx. 5 s).
- Wait until the green LED goes off and the red LED comes on again (approx. 5 s).
- Wait until the red LED goes off (another 5 s).
- Release the RESET button.

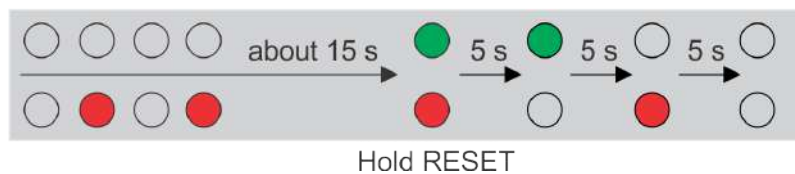

Caution

- In case of resetting the factory default settings on a device with a version of firmware 2.18 or higher it is necessary to reprogram the **2N[®] Security Relay** using the instructions from section **2.4**.

2.6 Downloads

Software

2N[®] IP Eye

2N[®] Network Scanner

3. Technical Parameters

Supported Protocols

- **LAN interface:** IPv4, ARP, TCP, UDP, DHCP, ONVIF
- **Device configuration:** HTTP/HTTPS
- **Call signalling:** SIP 2.0 (UDP)
- **Audio data transmission:** RTP (G.711, G.729, G.722, L16/16kHz)
- **Audio streaming:** RTSP
- **Time synchronisation:** SNTP
- **Auto provisioning:** TFTP
- **E-mail sending:** SMTP

Power Supply

- **External power supply:** 9 to 36 V \pm 10 % / 2 A DC or PoE, typically 12 V DC
- **PoE:** 802.3af (Class 0 - up to 12.95 W)
- **Power consumption:** 2 W at relax

Note

- If you feed the device from a DC power source and the supply voltage is lower than 12 V, then the output voltage is limited to the supply voltage value.

LAN Interface

- **LAN interface count:** 1 (since HW version 568v2)
- **PoE:** 802.3af on LAN1 only
- **Parameters:** 10/100BASE-TX with Auto-MDIX, RJ-45
- **Recommended cabling:** Cat-5e or higher

Video Interface

- **Video input count:** 2 (IN1, IN2)
- **Video input format:** PAL or NTSC composite signal
- **Camera power supply:** 12 V, max 500 mA (+12 V, VGND)

Video stream

- **Protocols:** RTP / RTSP / HTTP
- **Codecs:** H.263, H.263+, H.264, MPEG-4, M-JPEG
- **IP camera function:** Yes, ONVIF v2.4 profile S compatible

Bandwidth

- **Audio codecs**
 - PCMA, PCMU – 64 kbps (with 85.6 kbps headers)
 - G.729 – 16 kbps (with 29.6 kbps headers)
 - G.722 – 64 kbps (with 85.6 kbps headers)
 - L16 / 16 kHz – 256 kbps (with 277.6 kbps headers)

- **V i d e o c o d e c s**

Set the video codec data flows in the Services / Phone / Video menu for calls and in the Services / Streaming / RTSP menu for streaming. The set bandwidth represents the value that the codec has to approach on a long-time average. The data flows can vary depending on the scene to be scanned.

The measured data flow values correspond to the test view of a person standing in front of the intercom.

- **H.264**
 - Low quality: QVGA (320 x 240), 10 fps, 256 kbps: 181 kbps (with 190 kbps headers)
 - Medium quality: VGA (640 x 480), 15 fps, 768 kbps: 600 kbps (with 661 kbps headers)
 - High quality: VGA (640 x 480), 30 fps, 2048 kbps: 1319 kbps (with 1372 kbps headers)
- **MJPEG**
 - Low quality: QVGA (320 x 240), 10 fps, quality 70: 435 kbps with headers
 - Medium quality: VGA (640 x 480), 15 fps, quality 85: 506 kbps

Audio Interface

- **Microphone input:** Standard electret microphone, Max. $V_{pp} = 100$ mV, $R_{in} = 4,4$ k Ω , $V_{bias} = 1,5$ V
- **Line input:** Max. 755 mV RMS, $R_{in} = 47$ k Ω
- **Amplifier output:** 10 W amplifier of class D, MONO output, THD < 1 %, minimum loudspeaker impedance: 4 Ω
- **Line output:** Max. 755 mV RMS, $R_{out} = 600$ Ω
- **Acoustic echo cancelling:** AEC, full duplex

Button/Keypad Interface

- **Button count:** Up to 16 separate buttons in 4×4 matrix
- **Button function:** User programmable
- **Matrix outputs**
 - 4 (ROW1–4 terminals)
 - $U_{out} < 0.1$ V (L), $U_{out} > 3.2$ V (H), up to 8 mA
- **Matrix inputs**
 - 4 (COL1–4 terminals)
 - $U_{in} < 1.15$ (L), $U_{in} > 2.15$ V, max. $U_{in} = 5$ V

LED Control Outputs

- **Output count:** 3 (LED1 \pm , LED2 \pm and LED3 \pm terminals)
- **Output function:** User programmable
- **Output current:** Typ. 20 mA
- **Output voltage:** Up to 12 V

Digital Outputs

- **Output count:** 2 (OUT1 \pm and OUT2 \pm terminals)
- **Output function:** User programmable
- **Output type:** Power output with short-circuit protection
- **Output voltage**
 - PoE power supply: 10 V DC
 - External power supply: Power supply voltage minus 2 V, maximum 11 V DC
- **Output current:** Up to 600 mA

Digital Inputs

- **Input count:** 2 (IN1± and IN2± terminals)
- **Input function:** User programmable
- **Input type:** Galvanically isolated inputs (opto-couplers)
- **Characteristics:** $U_{in} < 1.1 \text{ V (L)}$, $U_{in} > 3 \text{ V (H)}$, max. $U_{in} = 32 \text{ V}$

Relay Output

- **Output count:** 1 (NC, NO, COM terminals)
- **Output function:** User programmable
- **Limits (DC):** Up to 30 V DC / 1 A
- **Limits (AC):** Up to 125 V AC / 0.3 A

Mechanical Properties

- **Working temperature:** $-40 \text{ °C} - 55 \text{ °C}$
- **Working relative humidity:** 10 % - 95 % (non-condensing)
- **Storing temperature:** $-40 \text{ °C} - 70 \text{ °C}$
- **Dimensions**
 - 142 x 98 x 34 mm (Part No. 9154100)
 - 138 x 90 x 26 mm (Part No. 9154101)
- **Weight**
 - Up to 280 g (Part No. 9154100)
 - Up to 150 g (Part No. 9154101)
- **Protection class**
 - IP20 (Part No. 9154100)
 - IP00 (Part No. 9154101)

4. Supplementary Information

Here is what you can find in this section:

- 4.1 Troubleshooting
- 4.2 Directives, Laws and Regulations
- 4.3 General Instructions and Cautions

4.1 Troubleshooting



For the most frequently asked questions refer to faq.2n.cz.

4.2 Directives, Laws and Regulations

2N[®] IP Video Kit conforms to the following directives and regulations:

- 2014/35/EU for electrical equipment designed for use within certain voltage limits
- 2014/30/EU for electromagnetic compatibility
- 2011/65/EU on the restriction of the use of certain hazardous substances in electrical and electronic equipment
- 2012/19/EU on waste electrical and electronic equipment

 **Caution****Warning**

In order to ensure the full functioning and guaranteed outputs we strongly recommend a verification of the timeliness of version of product or facility already during the installation process. The customer takes into consideration that the product or facility can achieve the guaranteed outputs and be fully operational pursuant to the producer's instructions only by using the most recent version of product or facility, which has been tested for full interoperability and has not been determined by the producer as incompatible with certain versions of other products, only in conformity with the producer's instructions, guidelines, manual or recommendation and only in conjunction with suitable products and facilities of the other producers. The most recent versions are available on the website https://www.2n.cz/cs_CZ/, or specific facilities, depending on their technical capacity, allow updating in the configuration interface. Should the customer use any other version of product or facility than the most recent one, or the version that has been determined by the producer as incompatible with certain versions of other producers' products of facilities, or the product or facility in a way incompatible with the producer's instructions, guidelines, manual or recommendation or in conjunction with unsuitable products or facilities of the other producers, he or she is aware of all potential limitations of functionality of such a product or facility and all relating consequences. Should the customer use any other than the most recent version of the product or facility, or the version that has been determined by the producer as incompatible with certain versions of other producers' products of facilities, or the product or facility in a way incompatible with the producer's instructions, guidelines, manual or recommendation or in conjunction with unsuitable products or facilities of the other producers, he or she agrees that the company 2N TELEKOMUNIKACE a. s. is not liable neither for any limitation of such a product's functionality, nor for any damage, loss or injury relating to such a potential limitation of functionality.

4.3 General Instructions and Cautions

Please read this User Manual carefully before using the product. Follow all instructions and recommendations included herein.

Any use of the product that is in contradiction with the instructions provided herein may result in malfunction, damage or destruction of the product.

The manufacturer shall not be liable and responsible for any damage incurred as a result of a use of the product other than that included herein, namely undue application and disobedience of the recommendations and warnings in contradiction herewith.

Any use or connection of the product other than those included herein shall be considered undue and the manufacturer shall not be liable for any consequences arisen as a result of such misconduct.

Moreover, the manufacturer shall not be liable for any damage or destruction of the product incurred as a result of misplacement, incompetent installation and/or undue operation and use of the product in contradiction herewith.

The manufacturer assumes no responsibility for any malfunction, damage or destruction of the product caused by incompetent replacement of parts or due to the use of reproduction parts or components.

The manufacturer shall not be liable and responsible for any loss or damage incurred as a result of a natural disaster or any other unfavourable natural condition.

The manufacturer shall not be held liable for any damage of the product arising during the shipping thereof.

The manufacturer shall not make any warrant with regard to data loss or damage.

The manufacturer shall not be liable and responsible for any direct or indirect damage incurred as a result of a use of the product in contradiction herewith or a failure of the product due to a use in contradiction herewith.

All applicable legal regulations concerning the product installation and use as well as provisions of technical standards on electric installations have to be obeyed. The manufacturer shall not be liable and responsible for damage or destruction of the product or damage incurred by the consumer in case the product is used and handled contrary to the said regulations and provisions.

The consumer shall, at its own expense, obtain software protection of the product. The manufacturer shall not be held liable and responsible for any damage incurred as a result of the use of deficient or substandard security software.

The consumer shall, without delay, change the access password for the product after installation. The manufacturer shall not be held liable or responsible for any damage incurred by the consumer in connection with the use of the original password.

The manufacturer also assumes no responsibility for additional costs incurred by the consumer as a result of making calls using a line with an increased tariff.

Electric Waste and Used Battery Pack Handling



Do not place used electric devices and battery packs into municipal waste containers. An undue disposal thereof might impair the environment!

Deliver your expired electric appliances and battery packs removed from them to dedicated dumpsites or containers or give them back to the dealer or manufacturer for environmental-friendly disposal. The dealer or manufacturer shall take the product back free of charge and without requiring another purchase. Make sure that the devices to be disposed of are complete.

Do not throw battery packs into fire. Battery packs may not be taken into parts or short-circuited either.



2N TELEKOMUNIKACE a.s.

Modřanská 621, 143 01 Prague 4, Czech Republic

Phone: +420 261 301 500, Fax: +420 261 301 599

E-mail: sales@2n.cz

Web: www.2n.cz

v2.15