



# **2N<sup>®</sup> IP Safety**

## **Emergency IP Intercom**



### **Installation Manual**

**Firmware:** 2.14  
**Version:** 2.14

[www.2n.cz](http://www.2n.cz)

The 2N TELEKOMUNIKACE a.s. is a Czech manufacturer and supplier of telecommunications equipment.



The product family developed by 2N TELEKOMUNIKACE a.s. includes GSM gateways, private branch exchanges (PBX), and door and lift communicators. 2N TELEKOMUNIKACE a.s. has been ranked among the Czech top companies for years and represented a symbol of stability and prosperity on the telecommunications market for almost two decades. At present, we export our products into over 120 countries worldwide and have exclusive distributors on all continents.



2N<sup>®</sup> is a registered trademark of 2N TELEKOMUNIKACE a.s. Any product and/or other names mentioned herein are registered trademarks and/or trademarks or brands protected by law.



2N TELEKOMUNIKACE a.s. administers the FAQ database to help you quickly find information and to answer your questions about 2N products and services. On [www.faq.2n.cz](http://www.faq.2n.cz) you can find information regarding products adjustment and instructions for optimum use and procedures „What to do if...“.



2N TELEKOMUNIKACE a.s. hereby declares that the 2N product complies with all basic requirements and other relevant provisions of the 1999/5/EC directive. For the full wording of the Declaration of Conformity see the CD-ROM (if enclosed) or our website at [www.2n.cz](http://www.2n.cz).



This device complies with part 15 of the FCC Rules. Operation is subject to the following two conditions: (1) This device may not cause harmful interference, and (2) this device must accept any interference received, including interference that may cause undesired operation.



The 2N TELEKOMUNIKACE a.s. is the holder of the ISO 9001:2009 certificate. All development, production and distribution processes of the company are managed by this standard and guarantee a high quality, technical level and professional aspect of all our products.

---

# Content:

---

- 1. Product Overview
  - 1.1 Components and Associated Products
  - 1.2 Terms and Symbols
- 2. Description and Installation
  - 2.1 Before You Start
  - 2.2 Mechanical Installation
  - 2.3 Electric Installation
    - 2.3.1 Overvoltage Protection
  - 2.4 Extending Module Connection
- 3. Function and Use
  - 3.1 Configuration
  - 3.2 Maintenance
  - 3.3 Downloads
- 4. Technical Parameters
  - 4.1 General drawings
- 5. Supplementary Information
  - 5.1 Troubleshooting
  - 5.2 Directives, Laws and Regulations
  - 5.3 General Instructions and Cautions

# 1. Product Overview

---

Here is what you can find in this section:

- 1.1 Components and Associated Products
- 1.2 Terms and Symbols

---

## Basic Features

---

**2N<sup>®</sup> IP Safety** is a highly resistant and reliable IP door access intercom provided with a lot of useful above-standard functions. Supporting the SIP standard and being compatible with the leading IP PBX and telephone suppliers, **2N<sup>®</sup> IP Safety** can make use of all VoIP services. **2N<sup>®</sup> IP Safety** can work as a standard or emergency door access intercom for buildings, entrances to premises or garages, manufacturing halls, highways and so on.

**2N<sup>®</sup> IP Safety** is equipped with two very sensitive microphones and an up to 10 W loudspeaker. Thanks to an integrated acoustic echo cancelling (AEC) system, the product provides mutual audibility even of persons talking at the same time under normal conditions.

**2N<sup>®</sup> IP Safety** can be provided with pre-programmed buttons. You can set up to three telephone numbers and time profiles for each of the buttons to increase the accessibility of the called party.

**2N<sup>®</sup> IP Safety** is equipped with an electric lock switch. You can control the switch using a numerical keypad or, during a call, using any telephone set. An additional switch module can be installed if necessary. A wide range of settings allow for a variety of applications.

**2N<sup>®</sup> IP Safety** is very easy to install. All you have to do is connect the system into your LAN via a network cable and feed it from a 12 V power supply or your PoE supporting LAN.

Configure **2N<sup>®</sup> IP Safety** using your PC via any web browser. Use the **2N<sup>®</sup> Access Commander** to manage extensive **2N<sup>®</sup> IP Safety** systems easily and quickly.

---

## Advantages of Use

---

- Uncompromising Antivandal design
- High coverage level - up to class IP69K
- Variable mounting options (brick/plasterboard flush mounting, surface mounting)
- Sensitive microphone and powerful loudspeaker
- Bidirectional communication - acoustic echo cancelling
- Optional dial buttons including backlight
- Integrated electronic lock switches with wide setting options
- LAN (PoE) or external 12 V power supply
- Configuration via web interface or dedicated PC application
- SIP 2.0 support
- Up to 1999 telephone directory positions
- Up to 20 user time profiles
- Video codecs (H.263, H.263+, H.264, MPEG-4, JPEG)
- Audio codecs (G.711, G.729, G.722, L16/16 kHz)
- HTTP server for configuration
- SNTP client for time synchronisation with server
- RTSP server for video streaming
- SMTP client for e-mail sending
- TFTP client for automatic configuration and firmware update

## 1.1 Components and Associated Products

### Basic Units

2N Part No. 9152101W

Axis Part No. 01353-001



- 1 button
- 10 W loudspeaker
- extra robust version
- control of two electric locks
- possibility of connecting additional switch

2N Part No. 9152102W

Axis Part No. 01354-001



- 2 buttons with „INFO“ and „SOS“ labels
- 10 W loudspeaker
- extra robust version
- control of two electric locks



2N Part No. 9152101MW

Axis Part No. 01355-001



- 1 red emergency button
- 10 W loudspeaker
- extra robust version
- control of two electric locks
- possibility of connecting additional switch

2N<sup>®</sup> IP Safety units can wall mounted without requiring any additional accessories. Use the appropriate mounting box (see below) for plasterboard and flush mounting.

## Flush Mounting Box

2N Part No. 9152000

Axis Part No. 01356-001

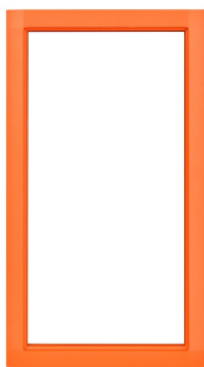

- Mounting frame
- Orange
- Aluminum
- Good to cover the edge of the intercom in flush or plasterboard installation.

2N Part No. 9151001

Axis Part No. 01348-001



- Brick flush mounting box
- Stainless steel
- Dimension: 132 x 223 x 83 mm

2N Part No. 9151002

Aixs Part No. 01349-001



- Plasterboard flush mounting box
- Dimension: 237 x 129 x 70 mm
- Hole: 237 x 118 mm

## Mounting Accessories

2N Part No. 9151005

Axis Part No. 01351-001



- Gooseneck stand
- Height 120 cm (47 inch) to the top of the intercom

2N Part No. 9151007

Axis Part No. 01550-001



- Gooseneck stand double
- Height 115 cm (45") and 203 cm (80")

2N Part No. 9151006

Axis Part No. 01352-001



- Installation adapter (US only)

2N Part No. 9151018

Axis Part No. 01345-001



- Security screws
- An alternative that is safer than regular screws.
- Torx with a pin. Supplied with the appropriate handle.

## Internal Units and Accessories

Part Numbers:

2N Part No. 91378375

Axis Part No. 01668-001

2N Part No. 91378375

Axis Part No. 01670-001



- 2N<sup>®</sup> Indoor Touch 2.0 - black
- WiFi version (second part no.)
- The elegant internal touch panel, 2N<sup>®</sup> Indoor Touch 2.0 , is suitable for all 2N IP intercoms. On the panel's display not only can you find out who is at the door, but also start a conversation with the visitor, open the lock or turn on the light in the entrance hall.

2N Part No. 91378382

Axis Part No. 01425-001



- 2N<sup>®</sup> Indoor Touch desk stand black

**Part Numbers:**

2N Part No. 91378375WH

Axis Part No. 01669-001

2N Part No. 91378376WH

Axis Part No. 01671-001



- 2N<sup>®</sup> Indoor Touch 2.0 - white
- WiFi version (second part no.)
- The elegant internal touch panel, 2N<sup>®</sup> Indoor Touch 2.0, is suitable for all 2N IP intercoms. On the panel's display not only can you find out who is at the door, but also start a conversation with the visitor, open the lock or turn on the light in the entrance hall.

2N Part No. 91378382W

Axis Part No. 01426-001

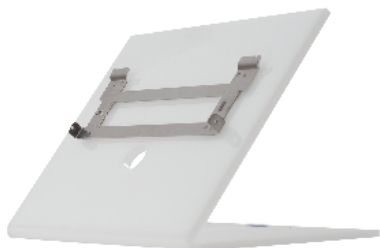

- 2N<sup>®</sup> Indoor Touch desk stand white

## VoIP Telephones

2N Part No. 91378357

Axis Part No. 01422-001



- Grandstream GXV3240 VoIP video telephone
- GXV3240 is the successor to the popular GXV3140 model, which allows comfortable video calls in the IP network. Touchscreen and keyboard control.

2N Part No. 91378358

Axis Part No. 01421-001



- Grandstream GXV3275 VoIP telephone
- GXV3275 is the successor to the popular GXV3175 model, which allows comfortable video calls in the IP network. Touchscreen control.



## Electric Locks

<p>Part No. 932071E</p> 	<ul style="list-style-type: none"><li>• BEFO 11211</li><li>• 12 V / 230 mA DC</li><li>• low consumption</li></ul>
<p>Part No. 932081E</p> 	<ul style="list-style-type: none"><li>• BEFO 11221 with momentum pin</li><li>• 12 V / 230 mA DC</li><li>• low consumption</li><li>• For opening of the lock a short electrical impuls is sufficient, which unlocks the lock. Lock is then open until someone closes the door.</li></ul>
<p>Part No. 932091E</p> 	<ul style="list-style-type: none"><li>• BEFO 11211MB with mechanical blocking</li><li>• 12 V / 230 mA DC</li><li>• low consumption</li><li>• Enables mechanically close or open the lock. When opened, the lock is open all the time. When closed, it behaves as standart electrical lock.</li></ul>

<p>Part No. 932061E</p> 	<ul style="list-style-type: none"> <li>• BEFO 211211 door signalling, low consumption</li> <li>• 12 V / 230 mA</li> <li>• A regular lock with a built-in contact to indicate whether the door is open or closed.</li> </ul>
<p>Part No. 932072E</p> 	<ul style="list-style-type: none"> <li>• BEFO 31211</li> <li>• fail-safe</li> <li>• 12 V / 170 mA DC</li> <li>• The failsafe lock is closed when electricity is switched on. When electricity is interrupted, the lock is opened.</li> </ul>
<p>Part No. 932062E</p> 	<ul style="list-style-type: none"> <li>• BEFO 321211</li> <li>• fail-safe, door signalling</li> <li>• 12 V / 170 mA</li> <li>• The failsafe lock is closed when electricity is switched on. When electricity is interrupted, the lock is opened.</li> <li>• It contains a built-in contact to indicate whether the door is open or closed.</li> </ul>

 **Tip**

- FAQ: Electric locks - Difference between locks in 2N IP intercoms accessories

## Power Supply

### Part Numbers:

2N Part No. 91378100E

2N Part No. 91378100US

Axis Part No. 01403-001



- PoE injector - with EU cable
- PoE injector - with US cable
- For power supply of intercom via ethernet cable when PoE switch is not available.

### Part No. 91341481E



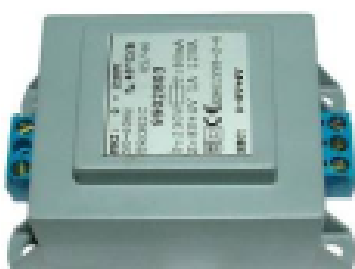

- Stabilised 12 V / 2 A power supply needs to be used when no PoE is available.

### Part No. 932928

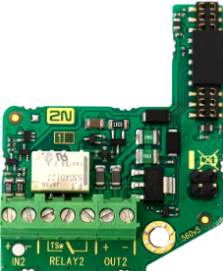

- 12 V transformer
- For 230 V mains voltage.
- For external power supply of the lock with 12 V AC voltage.

## Additional Modules

<p>2N Part No. 9151010 Axis Part No. 01350-001</p> 	<ul style="list-style-type: none"> <li>• Additional switch with normally open/closed contact and 12 V switched output.</li> <li>• Includes tamper switch.</li> <li>• Enables control of a secondary device, passive time unlimited switching up to 48 V / 2 A or active switch 12 V / 700 mA. Also includes tamper switch to signal opening of the front panel. Another one input is available.</li> </ul>
<p>2N Part No. 9159010 Axis Part No. 01386-001</p> 	<ul style="list-style-type: none"> <li>• <b>2N<sup>®</sup> Security Relay</b></li> <li>• A handy add-on that significantly enhances door entry security as it prevents tampering with the intercom and forced opening of the lock. To be installed between intercom and lock, powered by the intercom.</li> </ul>
<p>2N Part No. 9137410E Axis Part No. 01397-001</p> 	<ul style="list-style-type: none"> <li>• External IP Relay - 1 output</li> <li>• Standalone IP device which can be controlled by <b>HTTP</b> commands sent by <b>2N IP intercom</b>, which can thus control devices on unlimited distance.</li> </ul>

<p>2N Part No. 9137411E Axis Part No. 01398-001</p> 	<ul style="list-style-type: none"> <li>• External IP Relay – 4 outputs, PoE</li> <li>• Standalone IP device which can be controlled by HTTP commands sent by <b>2N IP intercom</b>, which can thus control devices on unlimited distance.</li> </ul>
<p>Part No. 9159013</p> 	<ul style="list-style-type: none"> <li>• Exit button</li> <li>• (suitable for Security relay)</li> <li>• A button for connection to a logic input for opening a door inside a building.</li> </ul>
<p>2N Part No. 9159014EU/UK 2N Part No. 9159014US Axis Part No. 01404-001</p> 	<ul style="list-style-type: none"> <li>• 2N<sup>®</sup> 2Wire</li> <li>• (set of 2 adaptors and power source for EU/US/UK)</li> <li>• The 2N<sup>®</sup> 2Wire converter allows you to use existing wiring (2 wires) from your original door bell or door intercom to connect any IP device. You don't have to configure anything, and you only need one 2N<sup>®</sup> 2Wire unit at each end of the cable and a power source connected to at least one of these units.</li> </ul> <p>The 2N<sup>®</sup> 2Wire unit then provides <b>PoE</b> power not only to the second converter, but also to all other connected IP end devices.</p>

<p>2N Part No. 9159050 Axis Part No. 01391-001</p>  A white rectangular device with a blue ear icon and the text '2N IP INTERCOM LOOP' on its surface.	<ul style="list-style-type: none"><li>• 2N<sup>®</sup> Induction Loop</li><li>• An induction loop transmits sound wirelessly from the 2N IP intercom to the earphones of people with hearing disabilities and enables them to hear and perceive sounds better.</li></ul>
<p>2N Part No. 9159052 Axis Part No. 01393-001</p>  A black power supply unit with a three-pronged AC plug and a cable with a connector.	<ul style="list-style-type: none"><li>• Stabilised 12 V / 2 A power supply needs to be used when no PoE is available.</li></ul>
<p>2N Part No. 9159051 Axis Part No. 01392-001</p>  A black square external antenna with a white ear icon and the text '2N' on its surface.	<ul style="list-style-type: none"><li>• 2N<sup>®</sup> Induction loop - external antenna</li><li>• External antenna boosts the range of usability of the induction loop, so that the disabled user can receive the audio signal in wider area. Use an external antenna with the induction loop, Part No. 9159050. A 170 cm long interconnecting cable is included.</li></ul>

2N Part No. 9160501

Axis Part No. 0820-001

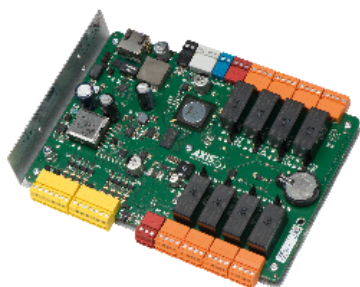

- AXIS A9188 Network I/O relay module
- Lift control relay module for up to 8 floors

## License

2N Part No. 9137905	<ul style="list-style-type: none"> <li>• Enhanced Audio</li> </ul>
2N Part No. 9137906	<ul style="list-style-type: none"> <li>• Enhanced Video</li> </ul>
2N Part No. 9137907	<ul style="list-style-type: none"> <li>• Enhanced Integration</li> </ul>
2N Part No. 9137908	<ul style="list-style-type: none"> <li>• Enhanced Security</li> </ul>
2N Part No. 9137909	<ul style="list-style-type: none"> <li>• Gold</li> </ul>
2N Part No. 9137910 Axis Part No. 01381-001	<ul style="list-style-type: none"> <li>• InformaCast</li> </ul>
2N Part No. 9137915	<ul style="list-style-type: none"> <li>• NFC</li> </ul>
2N Part No. 9137916	<ul style="list-style-type: none"> <li>• Lift Module</li> </ul>

 **Tip**

- Refer to the Configuration Manual for 2N IP intercoms, Subs. **3.2 Function Licensing** for details.

 **Tip**

- For more accessories and particular advice please contact your local distributor of 2N products.



## 1.2 Terms and Symbols

The following symbols and pictograms are used in the manual:

### **Safety**

- Always abide by this information to prevent persons from injury.

### **Warning**

- Always abide by this information to prevent damage to the device.

### **Caution**

- Important information for system functionality.

### **Tip**

- Useful information for quick and efficient functionality.

### **Note**

- Routines or advice for efficient use of the device.

## 2. Description and Installation

---

Here is what you can find in this section:

- 2.1 Before You Start
- 2.2 Mechanical Installation
- 2.3 Electric Installation
- 2.4 Extending Module Connection

## 2.1 Before You Start

---

### Product Completeness Check

Before you start please check the contents of your 2N<sup>®</sup> IP Safety delivery:

- 1x 2N<sup>®</sup> IP Safety
- 1x Torx 10 / Torx 20 double-ended wrench
- 1x spare sealing for big bushing for a thick cable, one hole
- 1x big blank with nut
- 1x brief manual
- 1x mounting template
- 1x grounding connector with the screw
- 4x screws (5 x 80) mm
- 4x "intelligent" (8 x 50) mm dowels
- 1x Certificate of ownership

#### Note

- Mounting frame is not included - it is sold separately as order no. 9152000.
- Bushing set is the same as for 2N<sup>®</sup> IP Force, but bushings are already mounted.

## 2.2 Mechanical Installation

---

### Content

Common Mounting Principles

Flush Mounting - Classic Bricks

Flush Mounting - Thermally Insulated Wall

Flush Mounting - Hollow Bricks

Flush Mounting - Plasterboard

Wall Mounting

Use of Cable Bushings

### Common Mounting Principles

 **Tip**

- Select flush mounting where possible to make your product elegant looking, more vandal resistant and more secure.
- You can purchase the flush mounting box in advance and hire an installation professional to make the basic installation work. Moreover, the mounting box helps you align the intercom vertically (with a deviation of up to 2°).

 **Caution**

- Before starting the mechanical installation on a selected place, make sure carefully that the preparations connected with it (drilling, wall cutting) cannot damage the electrical, gas, water and other existing wires and pipes.
- Make sure that the dowel holes have the required diameter. If the diameter is too large, the dowels may get loose. Use some suitable building adhesive to keep the dowels in place.
- Make sure that the hole depth is sufficient too! The dowel length is 50 mm and the screw length is 90 mm.
- Remember that dowels of poor quality may easily get loose and fall out of the wall!
- Stainless steel screws are used for the 2N<sup>®</sup> IP Safety assembly. Other screws than stainless steel ones corrode soon and may aesthetically deteriorate the surrounding environment!
- Having removed the front panel, make sure that no dirt gets inside the product (especially onto the sealing surface and microphone sound guides).

 **Caution**

- The warranty does not apply to the product defects and failures arisen as a result of improper mounting (in contradiction herewith). The manufacturer is neither liable for damages caused by theft within an area that is accessible after the attached electric lock is switched. The product is not designed as a burglar protection device except when used in combination with a standard lock, which has the security function.
- When the proper mounting instructions are not met, water might get in and destroy the electronics. It is because the intercom circuits are under continuous voltage and water infiltration causes an electro-chemical reaction. The manufacturer's warranty shall be void for products damaged in this way!

 **Note**

- The microphone sound guides are normally loose after the front panel is removed! The screw is only used as a fall-out protection during installation.

**Warning**

Be sure keep strictly the hole dimensions while mounting the device into classic bricks without the flush mounting box as shown in the picture with dimensions.

## Flush Mounting - Classic Bricks

### What You Need:

- The brick flush mounting box, Part No. 9151001
- The metal frame, Part No. 9152000
- Hole: (132 x 223 x 83) mm

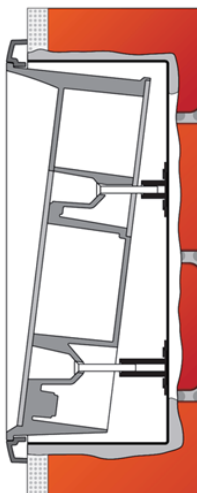

If you use the brick flush mounting box, follow the instructions below:

1. Make a hole using the template.
2. Suppose that all the required cables have been carried into the hole.
3. Put the intercom inside and place the set onto the hole to make sure that the hole is deep enough and the uneven edge is perfectly covered with the frame.
4. If the hole is perfect, wall in the flush mounting box.
5. Remove the front panel from the intercom.
6. Select the holes for cable supply. Insert the blanks into the other holes. Apply the cable bushings or a suitable sealant to prevent penetration of insects or water. You can also insert the small bushing in the intercom bottom hole.
7. Put the frame on the intercom.

8. Place the intercom into the flush mounting box while introducing the cables. Leave some of the cables inside the unit as a reserve and the rest under the intercom bottom.
9. Insert the supplied screws in the side mounting holes making sure that they penetrate into the flush mounting box nuts. Tighten all the screws properly. Tip: The screw tightening sequence may affect the intercom position.
10. We recommend to seal the frame - wall gap with a silicone or another sealant to avoid wall dampening as a result of water leakage.
11. Do not complete mounting until you have finished electrical installation.

## Flush Mounting - Thermally Insulated Wall

### What You Need:

- Longer screws (depending on the thermal insulation thickness)
- Hole: (112 x 220 x 70) mm

Cut out the thermal insulation layer using the template (the same as for classic brick wall).

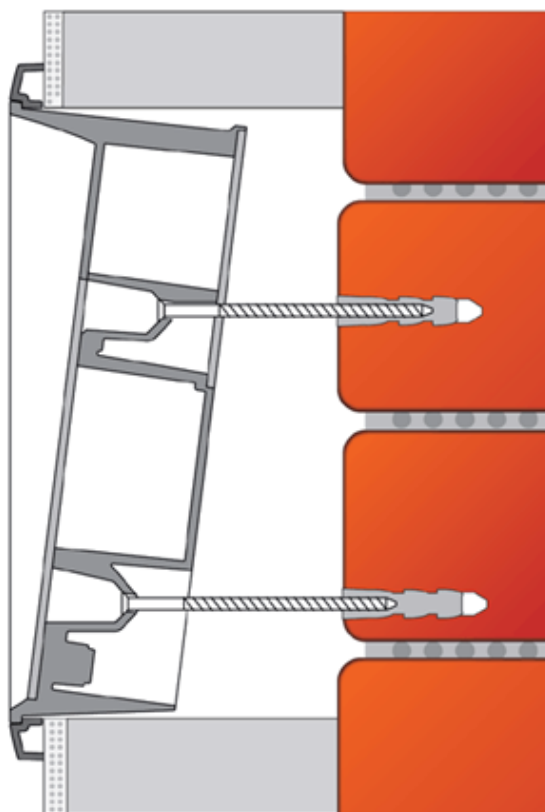

**⚠ Caution**

- The hole depth depends on the insulation layer thickness. If the insulation layer is rather thick, you may need longer screws! If there are hollow bricks under the insulation, make sure that your screws pass through the whole dowel (50 mm) and fix the dowel reliably.
- Make sure that the dowel holes have the required diameter. If the diameter is too large, the dowels may get loose. Use some suitable building adhesive to keep the dowels in place.
- Make sure that the hole depth is sufficient too! The dowel length is 50 mm and the screw length is 90 mm.

Suppose that all the required cables have been carried into the drilled hole. Now follow the instructions applicable for classic brick flush mounting. However, remember that thermally insulated walls show less strength than classic brick walls.

## Flush Mounting – Hollow Bricks

### What You Need:

- Brick flush mounting box, Part No. 9151001
- Hole: (132 x 223 x 83) mm

Suppose you intend to install your 2N<sup>®</sup> IP Safety unit into a wall made of hollow bricks. Note that the external side of the bricks gets damaged by cutting and the dowels cannot practically be fixed into the thin internal part of the bricks. Therefore, use the brick flush mounting box and follow the instructions included therein.

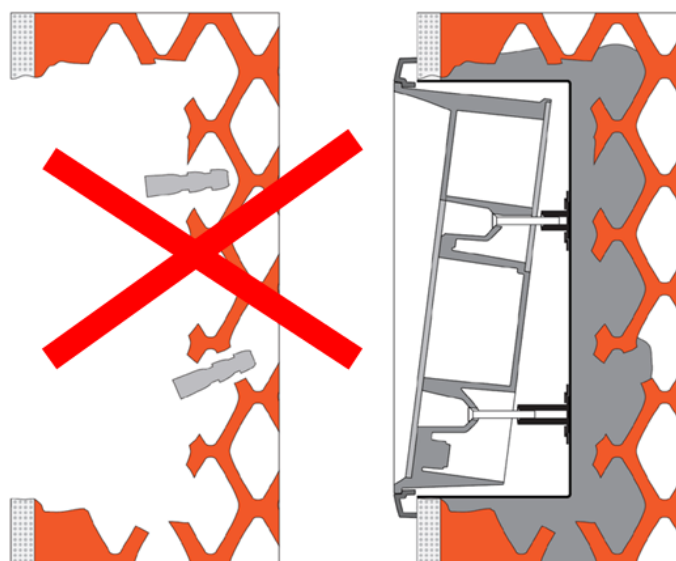



## Flush Mounting - Plasterboard

What You Need:

- Plasterboard flush mounting box, Part No. 9151002
- Hole: (118 x 237) mm



Use the plasterboard flush mounting box and follow the instructions included therein.

## Wall Mounting

What You Need:

- Just your 2N<sup>®</sup> IP Safety unit

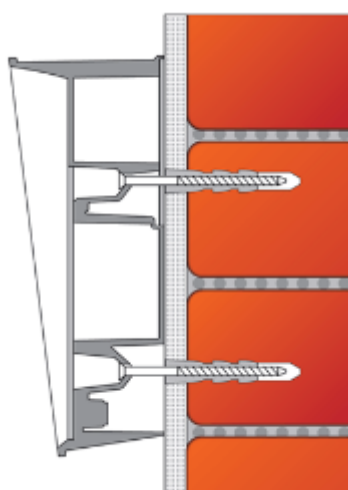

Wall (surface) mounting is used where flush mounting is inapplicable (in concrete and steel structures, entry barrier columns, etc.). The frame is not used.

#### **Caution**

- Wall mounting may be a problem where vandals may destroy the unit (in public garages, e.g.). Therefore, use steel fixing elements instead of the dowels and screws included in the delivery.
- Be sure to insert plugs into unused bushing holes to avoid water leakage during facade cleaning, for example. Never leave the holes open for even a short time (one day delay between mounting and cable connection, e.g.).

#### **Warning**

- Eliminate the risk of accident! Wall mounting is not suitable for narrow passages or places where people's attention may be distracted. The manufacturer shall not be liable for injuries incurred as a result of unsafe mounting!

1. Select the **2N<sup>®</sup> IP Safety** position with respect to the supply cables. Where the cables are installed inside a structure or wall, use the hole at the intercom bottom.
2. Drill holes of the depth of 70 mm for dowels in the wall as shown in the figure. Push or hammer the enclosed dowels into the drilled holes. Use some suitable building adhesive if the dowels are too loose. Use fixing elements of your own for steel structure surface mounting (metric screws + nuts, e.g.).
3. Remove the front panel from the intercom.
4. Select the holes for cable supply. Select and mount the bushings depending on the cables: 2-hole bushing or 1-hole bushing or both. Insert the blanks in the other holes.
5. Put the intercom on the wall/structure while introducing cables inside. Leave some of the cables inside the unit as a reserve. Insert the plugs in the unused bushings and tighten the bushing nuts carefully.
6. Do not complete mounting until you have finished electrical installation – refer to Mounting Completion. Where cables lead along the surface, use the bushings included in the delivery.

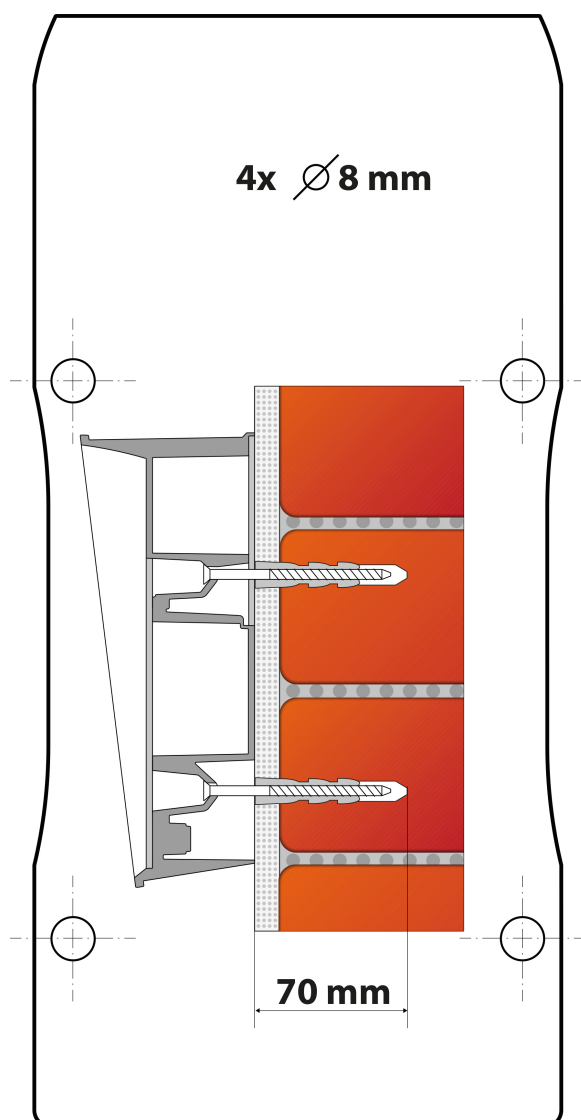

## Use of Cable Bushings

The cable bushings included in the 2N<sup>®</sup> IP Safety delivery are designed for the following cables:

- Big bushing: for two cables of the diameter of 5–6 mm (UTP cable), or, upon insert replacement, for one thick cable/tube of the diameter of up to 14 mm.
- Small bushing: for one cable of the diameter of 5–8 mm.

**Tip**

- Even a LAN cable including the RJ-45 connector can go through the big bushing. See below for instructions.

## How to Pull a RJ-45 Terminated Cable through a Bushing

1. Unscrew the big bushing nut completely.

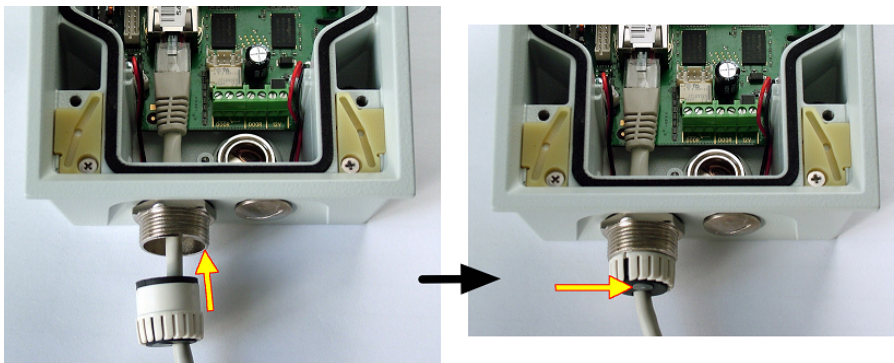

2. Remove the sealing including the cover from the bushing. Cut either of the components as shown in the figures.

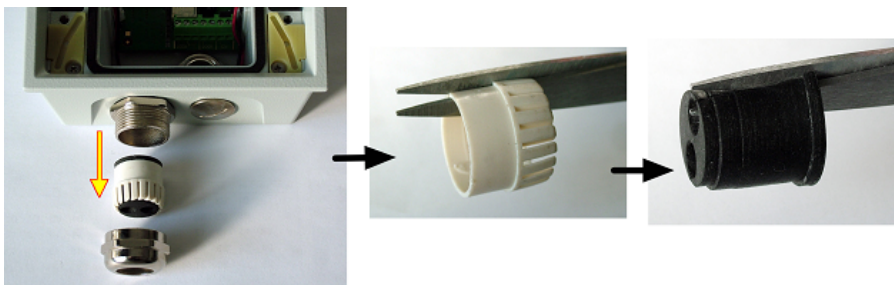

3. Put the bushing nut on the cable and insert the sealing.

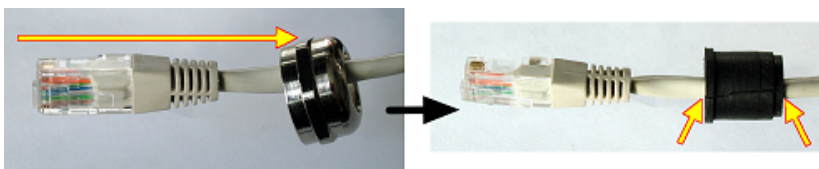

4. Replace the cover onto the sealing.



5. Pull the cable connector through the bushing body into the intercom and clip it into the motherboard connector.

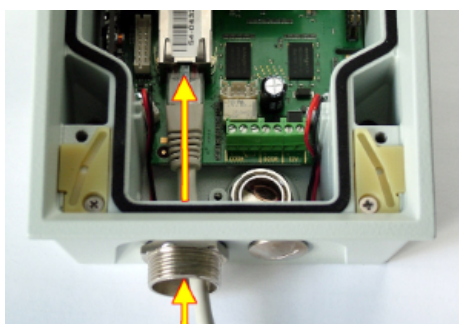

6. Move the sealing including the cover along the cable as far as the bushing body, or add a plug if necessary.

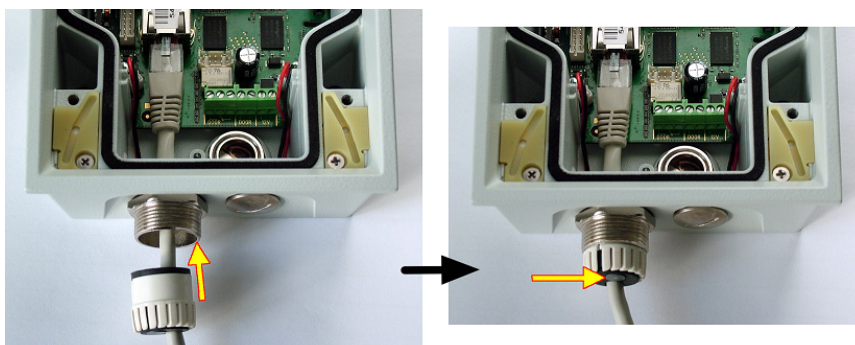

7. Replace and tighten the nut.

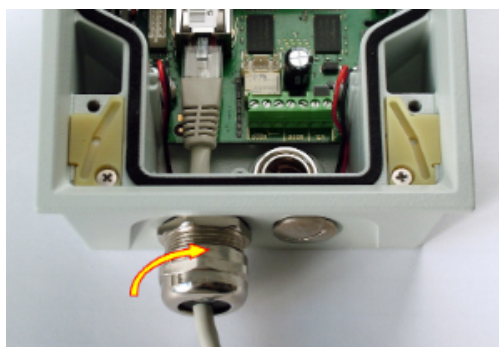

## 2.3 Electric Installation

---

This subsection describes how to connect 2N<sup>®</sup> IP Safety into your Local Area Network (LAN) and how to connect supply voltage and the electric lock.

- PCB Connectors
- LAN Connection
- External Power Supply Connection
- Electric Lock Connection
- Factory Default Resetting (PCB version 555v5)
- Factory Default Resetting (PCB version 555v3 and higher)
- Factory Default Resetting (PCB version 555v2)
- Grounding
- Mounting Completion
- Available Switches



### Caution

- The device must be part of the electrical system of the building.

## PCB Connectors

Picture shows the lay-out of connectors on the 2N<sup>®</sup> IP Safety printed circuit board (PCB). Cables, accessories and other system components are connected to connectors X1 through X22.

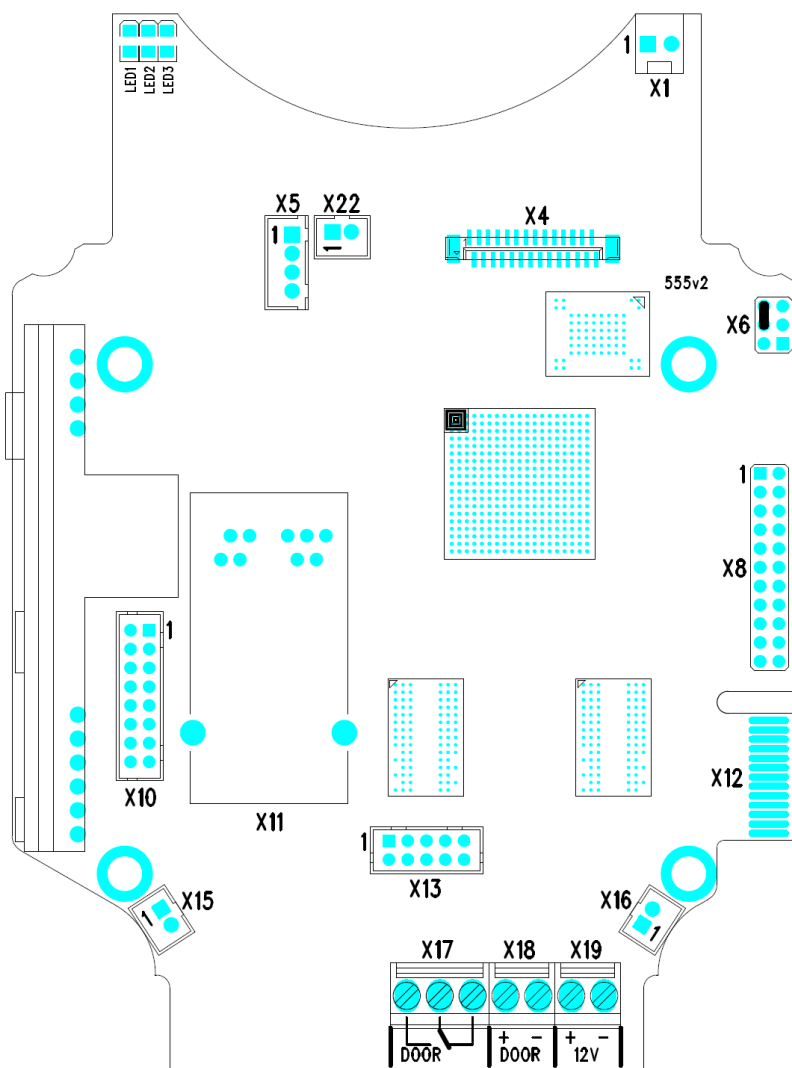

2N<sup>®</sup> IP Safety Connectors, PCB Version 555v2

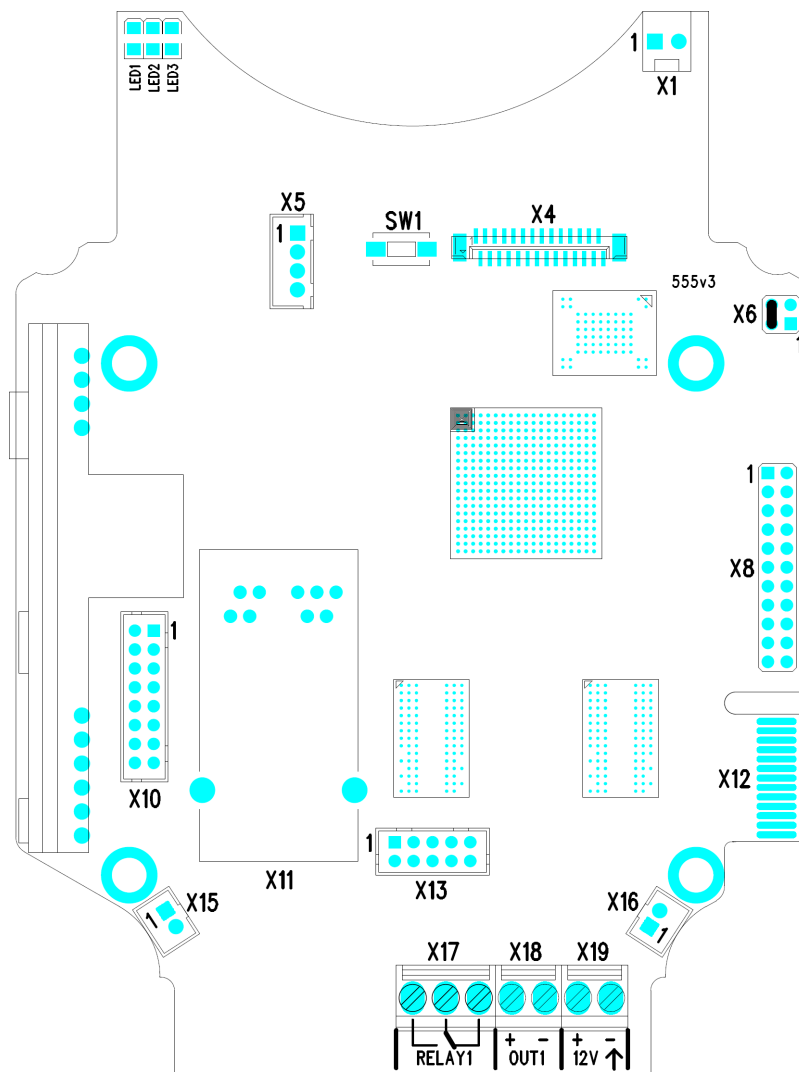

2N<sup>®</sup> IP Safety Connectors, PCB Version 555v3



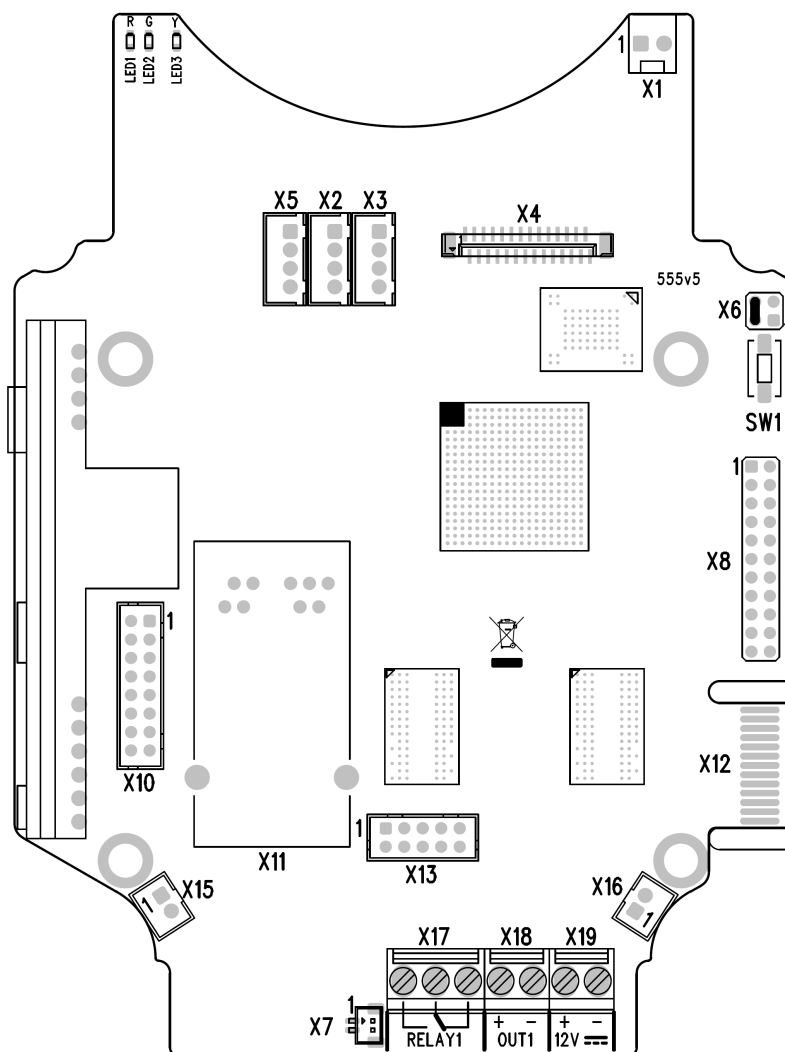

## 2N<sup>®</sup> IP Safety Connectors, PCB Version 555v5

Description of Connectors:

- X1 - Loudspeaker
- X4 - Camera module
- X5 - Button 1
- SW1 - Reset button (555v3 and higher versions only)
- X6 - Configuration jumpers
- X7 - Induction loop output. Connector type JST SHR-02V-S.
- X8 - Extending module (RFID card reader or additional switch)
- X10 - Buttons 1 through 4
- X11 - LAN
- X12 - Servicing connector

- X13 – Keypad module
- X15 – Left-hand microphone
- X16 – Right-hand microphone
- X17 – Relay NO and NC contact. Used for connection of non-critical devices only (lights, e.g.).
- X18 – 12 V / 600 mA switched output
- X19 – 12 V / 1 A DC power input
- LED1/2 – System status indicators
- LED3 – LAN connection activity indicator

✓ **Tip**

- Output wiring diagram for Relay terminals

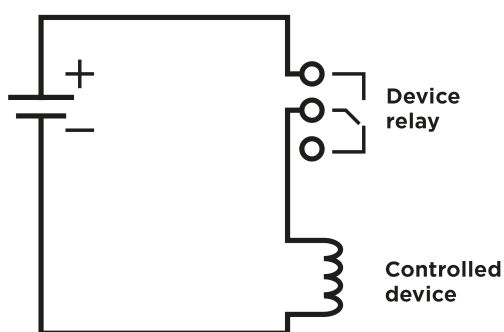

Wiring diagram for the controlled device's electric circuit closing

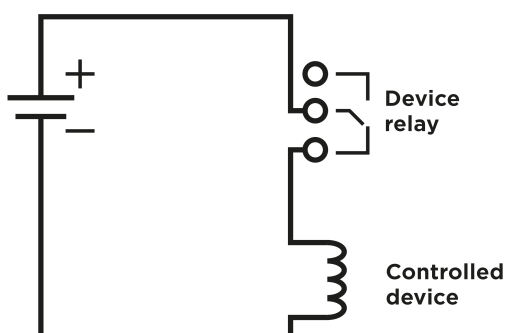

---

Wiring diagram for the controlled device's electric circuit opening

---

## LAN Connection

2N<sup>®</sup> IP Safety is connected to the LAN via a RJ-45 terminated (connector X11) UTP /STP cable (of category Cat 5e or higher). The system is equipped with the Auto-MDIX function and so both the straight and crossed cable versions can be used.

### Caution

- We recommend the use of a LAN surge protection.
- We recommend the use of a shielded SSTP Ethernet cable.

## External Power Supply Connection

2N<sup>®</sup> IP Safety can be fed either from an external 12 V / 1 A DC power supply or from the LAN equipped with the PoE 802.3af supporting network elements.

### External Power Supply

An external 12 V power supply is connected to terminal block X19. Use a 12 V  $\pm 15\%$  DC power source dimensioned to current intake of 1 A at least (Part No. 91341481E) to ensure a reliable function of your device.

### PoE Supply

2N<sup>®</sup> IP Safety is compatible with the PoE 802.3af (Class 0-12.95 W) technology and can be supplied directly from the LAN via compatible network elements. If your LAN is incompatible, insert the PoE injector, Part No. 91758100E, between 2N<sup>®</sup> IP Safety and the nearest network element.

## Reset Button

Located among the main unit connectors, the Reset button helps you reset the factory default values, restart the device, find the device IP address and switch the static /dynamic mode.

## IP Address Finding

Follow the instructions below to **identify the current IP address**:

- Press and hold the RESET button.
- Wait until the red and green LEDs go on simultaneously on the device and the acoustic signal  can be heard (approx. 15–35 s).
- Release the RESET button.
- The device automatically announces the current IP address.

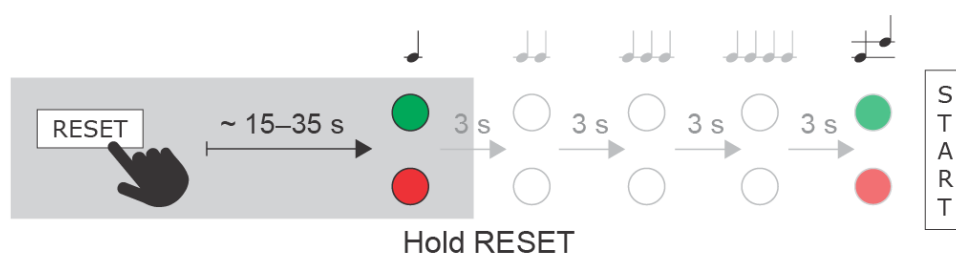



### **Note**

- The delay after pressing RESET till the first light and sound signalling is set to 15–35 s depending on the 2N IP intercom/answering unit model used.
  - 24 s is the valid value for 2N<sup>®</sup> IP Safety HW version 8.

## Static IP Address Setting

Follow the instructions below to switch on the **Static IP address** mode (DHCP OFF):

- Press and hold the RESET button.
- Wait until the red and green LEDs go on simultaneously on the device and the acoustic signal  can be heard (approx. 15–35 s).
- Wait until the red LED goes off and the acoustic signal  can be heard (approx. for another 3 s).
- Release the RESET button.

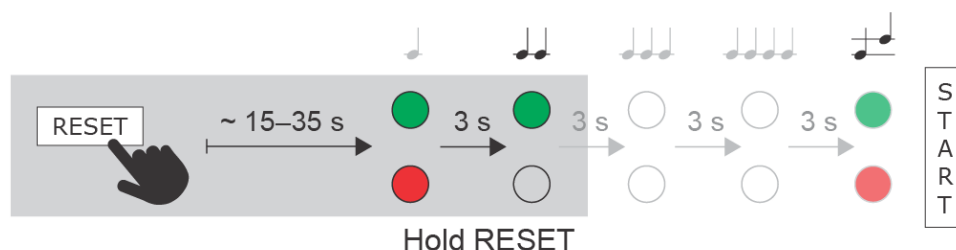

The following network parameters will be set after restart:

- IP address: 192.168.1.100
- Network mask: 255.255.255.0
- Default gateway: 192.168.1.1



## Dynamic IP Address Setting



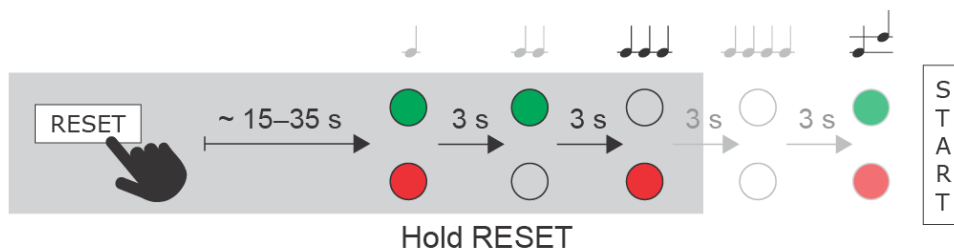

Follow the instructions below to switch on the **Dynamic IP address** mode (DCHP ON):

- Press and hold the RESET button.
- Wait until the red and green LEDs go on simultaneously on the device and the acoustic signal  can be heard (approx. 15–35 s).
- Wait until the red LED goes off and the acoustic signal  can be heard (approx. for another 3 s).
- Wait until the green LED goes off and the red LED goes on again and the acoustic signal  can be heard (approx. for another 3 s).
- Release the RESET button.



## Factory Reset (PCB version 555v8 and latest)

Follow the instructions below to **reset the factory default values**:

- Press and hold the RESET button.
- Wait until the red and green LEDs go on simultaneously and the acoustic signal  can be heard (approx. 15-35 s).
- Wait until the red LED goes off and the acoustic signal  can be heard (approx. for another 3 s).
- Wait until the green LED goes off and the red LED goes on again and the acoustic signal  can be heard (approx. for another 3 s).
- Wait until the red LED goes off and the acoustic signal  can be heard (approx. for another 3 s).
- Release the RESET button.

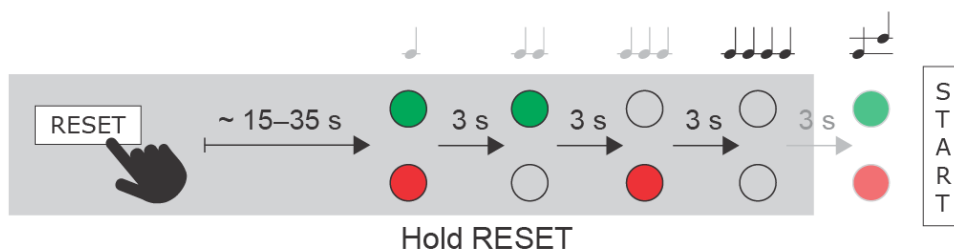

 **Caution**

- In case of resetting the factory default settings on a device with a version of firmware 2.18 or higher it is necessary to reprogram the 2N<sup>®</sup> Security Relay using the instructions from section 2.4.

## Device Restart

Press the RESET button shortly (< 1 s) to restart the system without changing configuration.

 **Note**

- The time interval between the short press of RESET and reconnection after restart is 25–50 s for 2N<sup>®</sup> IP Safety depending on the HW version.



## Factory Default Resetting (PCB version 555v3 and higher)

For resetting device to default settings press and hold SW1 button. Wait for the first sound signalization and then release the button. If you press the button for short time device will reboot only. SW1 button is available in devices with PCB version 555v3 and higher. For devices with PCB version 555v3 see procedure below.

### Caution

- In case of resetting the factory default settings on a device with a version of firmware 2.18 or higher it is necessary to reprogram the 2N<sup>®</sup> IP Security Relay using the instructions from section 2.4.

## Factory Default Resetting (PCB version 555v2)

1. Disconnect the device from the power supply.
2. Move the short-circuit jumper on connector X6 into the **Default setup** position. Configuration jumpers (X6) are located in the right-hand upper corner of the PCB.
3. Reconnect the power supply and wait for a start signalling sound.
4. Disconnect the device from the power supply.
5. Move the short-circuit jumper on connector X6 into the **Normal operation** position.
6. Reconnect the power supply. The device will be reset to factory default.

Configuration jumpers X6, PCB version 555v2:

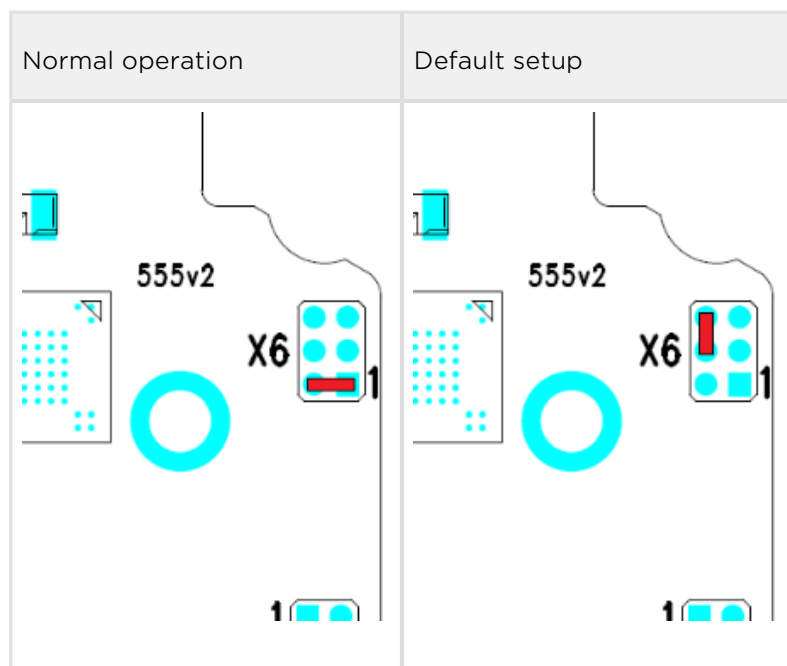

## Grounding

We recommend to ground the intercom in order to improve the static electricity resistance. For proper grounding you need a cable of the minimum cross-section of 4 mm<sup>2</sup>. Connect the cable to the connector in the bottom part of the intercom. The connector is enclosed to the delivery.

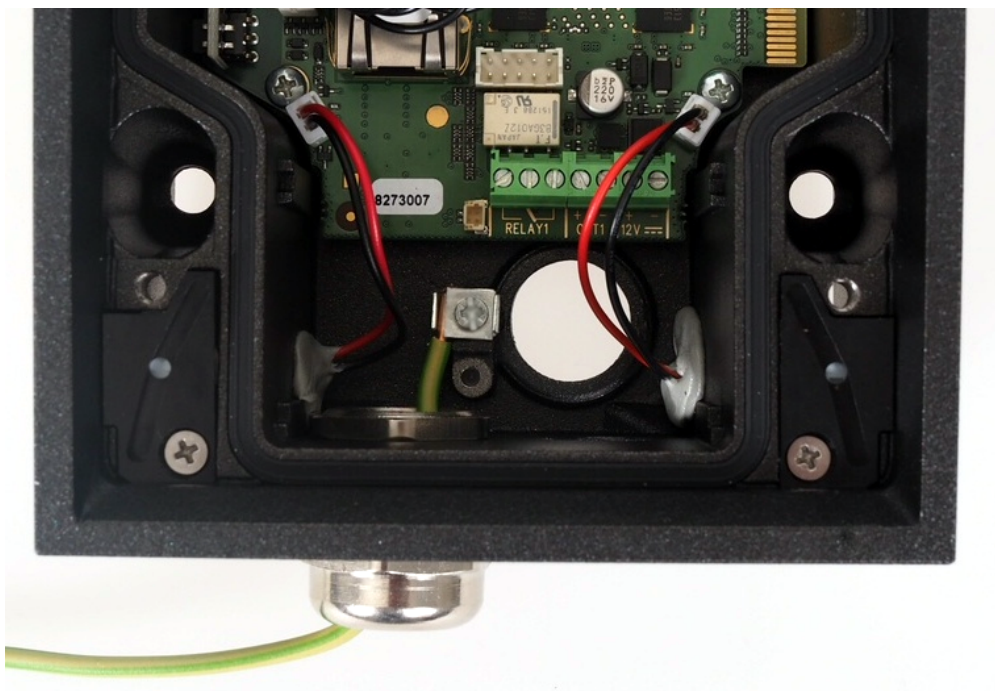

## Mounting Completion

1. Having connected all the wires, make sure that the bushings, if used, are tightened properly and the RJ-45 connector is inserted in the PCB connector.
2. Replace the front cover carefully. Make sure that the connector is inserted correctly and the wires inside the device leave enough space for the board if you are installing a four-button board. Tighten the four screws thoroughly with the wrench enclosed (Torx 20) to make the panel fit tightly to the metal chassis.

### Caution

- Properly installed intercom is waterproof. An incorrect mounting may compromise the intercom watertightness. Water leakage may damage the electronic part of the system.
- Stainless steel screws are used for the 2N<sup>®</sup> IP Safety assembly. Other screws than stainless steel ones corrode soon and may aesthetically deteriorate the surrounding environment!

## Available Switches

Location	Name	Description
Basic Unit	Relay 1	<b>Passive relay switch:</b> NO and NC contacts, up to 30 V / 1 A AC/DC. Used for connection of non-critical devices only (lights, e.g.).
	Output 1	<b>Active switch output:</b> 9 up to 13 V DC depending on power supply (PoE: 9 V; adaptor: power supply voltage minus 1 V), max 600 mA
Additional Switch (Part No. 9151010)	Relay 2	<b>Passive relay switch:</b> NO and NC contacts, up to 30 V / 1 A AC/DC. Used for connection of non-critical devices only (lights, e.g.).
	Output 2	<b>Active switch output :</b> 9 up to 13 V DC depending on power supply (PoE: 9 V; adaptor: power supply voltage minus 1 V), max 600 mA.

**Warning**

When you connect a device containing a coil, such as a relay or an electromagnetic lock, it is necessary to protect the intercom against voltage peak while switching off the induction load. For this way of protection we recommend a diode 1 A / 1000 V (e.g., 1N4007, 1N5407, 1N5408) connected antiparallel to the device.

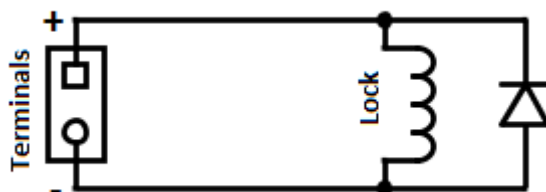

## 2.3.1 Overvoltage Protection

### Recommendations for Additional Overvoltage Protection Installation

If running:

- a) outside a building,
- b) on/in an outer wall or roof,

the 2N device wiring may be exposed to atmospheric effects resulting in overvoltage that may subsequently damage any devices installed outside the building, on its outer wall or roof. Overvoltage may damage devices connected to these wires and installed inside the building as well. Therefore, we recommend that additional surge protectors be installed on all the wires leading outside buildings, on outer walls or roofs, namely:

- a) as close as possible to the device installed outside the building or on its outer wall /roof,
- b) as close as possible to the point where the wires leave the building.

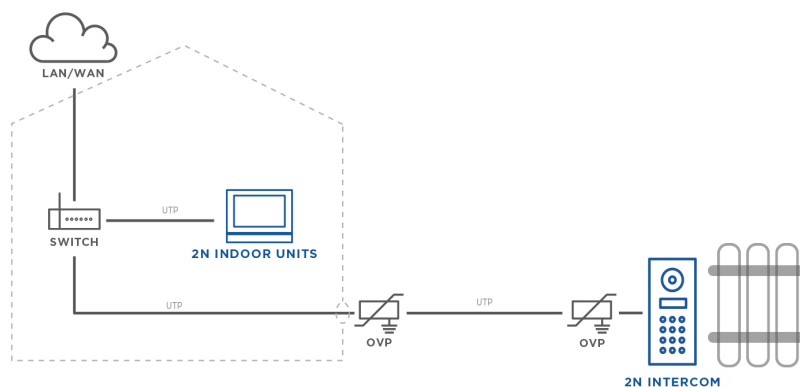
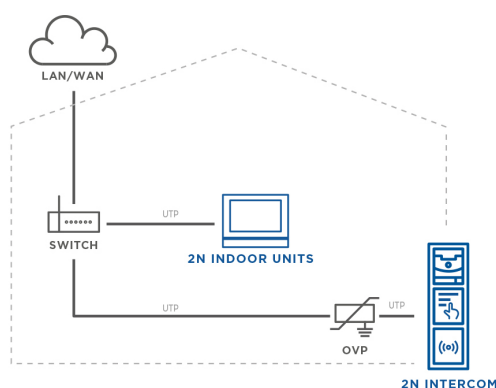

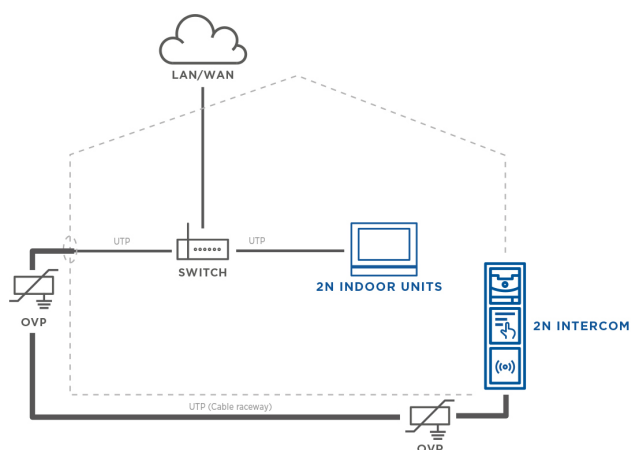

OVP = overvoltage protection

## 2.4 Extending Module Connection

2N<sup>®</sup> IP Safety allows to connect following extending modules:

- Additional Switch
- Security Relay
- Induction Loop

### Additional Switch

The **Additional Switch** (Part No. 9151010) is used for extending the number of inputs /outputs. This extending module is intended for mounting into the 2N<sup>®</sup> IP Safety main unit and is compatible with the basic units with Part No. 915210xxxxx. It is not possible to connect this module to main unit Part No. **9152102W**.

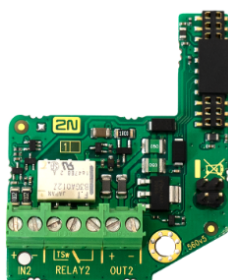

### Function:

The 2N<sup>®</sup> IPSafety Additional Switch adds two additional switches, one logical input and a tamper switch to the 2N<sup>®</sup> IP Safety basic unit. The purpose of the tamper switch is to signal any unauthorised opening of the intercom (to prevent a theft, e.g.). It is recommended to use the tamper switch.

#### Tip

- FAQ: Tamper switch – How to install it into the 2N<sup>®</sup> IP Force



## Specifications version 5:

- IN2 terminals for input in passive / active mode (-30 V to +30 V DC)
  - OFF = open OR  $U_{IN} > 1.5 \text{ V}$
  - ON = closed contact OR  $U_{IN} < 1.5 \text{ V}$
- RELAY2 terminals 30 V/1 A AC/DC NO/NC contact
- OUT2 active output: 12 V/600 mA DC
- Tamper switch input (X2): 24 V/50 mA AC/DC

## Specifications version 4 a lower:

- Passive switch: NO and NC contacts, up to 30 V / 1 A AC/DC
- Active switch output: 9 V (Using PoE) or power supply voltage minus 1 V, from 9 to 13 V max. 700 mA DC
- Tamper switch: 24 V / 50 mA AC/DC

## Module mounting:

1. Switch off the intercom.
2. Remove the front panel from the intercom. Do not disconnect the button cable!
3. Screw the enclosed 12 mm spacer (5) into the right-hand bottom slot on the main board.
4. Mount the enclosed plastic support (6) onto the switch board bottom side.
5. Put the switch board (4) in the main board connector making sure that the screw hole is directly above the spacer.
6. If you want to use the tamper switch, insert the tamper board (9) in the connector located in the right-hand bottom part of the switch board (4). As the tamper switch shares the relay output (NO and NC) terminals, you cannot use the RELAY2 output with the tamper switch together.
7. Place front panel back and tighten all four screws.

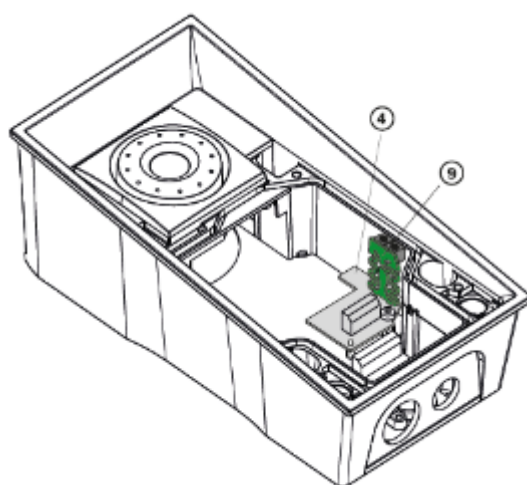
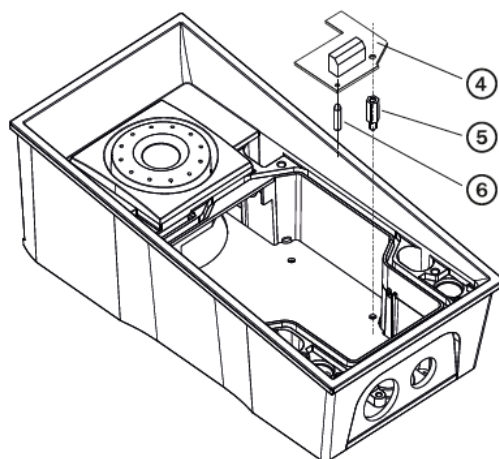

### Module settings:

Refer to the [Configuration Manual](#) for details.

## Connection:

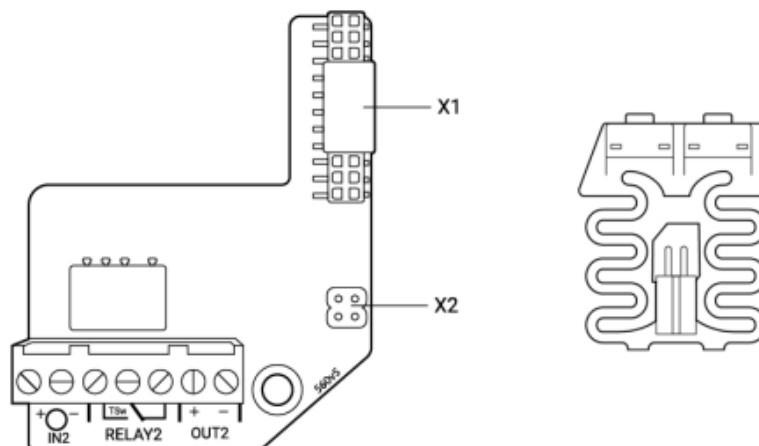

Version 5

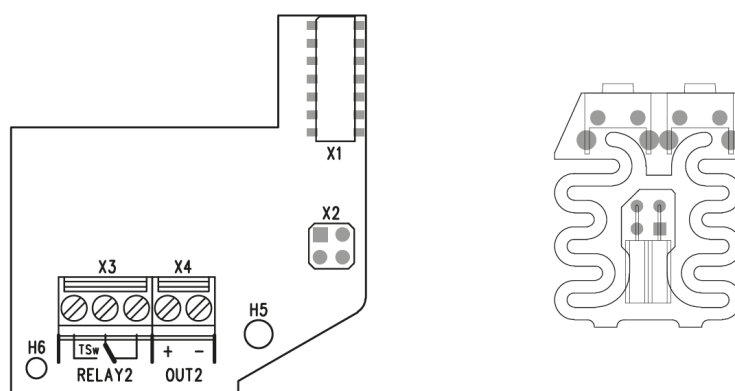

Version 4 and lower

## Security Relay

The **Security Relay** (Part No. 9159010) is used for enhancing security between the intercom and the connected electric lock. The **2N<sup>®</sup> Security Relay** is designed for any **2N IP intercom** model with firmware versions 1.15 and higher. It significantly enhances security of the connected electric lock as it prevents lock opening by forced intercom tampering.



## Function:

The 2N<sup>®</sup> Security Relay is a device installed between an intercom (outside the secured area) and the electric lock (inside the secured area). The 2N<sup>®</sup> Security Relay includes a relay that can only be activated if the valid opening code is received from the intercom.

## Specifications:

Passive switch: NO and NC contacts, up to 30 V / 1 A AC/DC

Switched output:

- Where the security relay is fed from the intercom, 9 to 13 V DC is available on the output depending on the power supply (PoE: 9 V; adapter: source voltage of minus 1 V) / 400 mA DC.
- Where the security relay is fed from an external power supply, 12 V / 700 mA DC is available on the output.

Dimensions: 56 x 31 x 24 mm

Weight: 20 g

## Installation:

Install the 2N<sup>®</sup> IP Security Relay onto a two-wire cable between the intercom and the electric lock inside the area to be secured (typically behind the door). The device is powered and controlled via this two-wire cable and so can be added to an existing installation. Thanks to its compact dimensions, the device can be installed into a standard mounting box.

## Connection:

Connect the 2N<sup>®</sup> Security Relay to the intercom as follows:

- To the intercom active output (OUT1 or OUT2 if a reader module or additional switch is connected)

Connect the electric lock to the 2N<sup>®</sup> Security Relay output as follows:

- To the switched output.
- To the passive output in series with the external power supply.

The device also supports a Departure button connected between the 'PB' and '- HeliosIP/IP Intercom' terminals. Press the Departure button to activate the output for 5 seconds.

## Status signalling:

Green LED	Red LED	Status
blinking	off	Operational mode
on	off	Activated output
blinking	blinking	Programming mode - waiting for initialisation
on	blinking	Error - wrong code received

## Configuration:

- Connect the 2N<sup>®</sup> Security Relay to the properly set intercom switch output; refer to the **Configuration Manual**. Make sure that one LED at least on the 2N<sup>®</sup> Security Relay is on or blinking.
- Press and hold the 2N<sup>®</sup> Security Relay Reset button for 5 seconds to put the device in the programming mode (both the red and green LEDs are blinking).
- Activate the intercom switch using the keypad, telephone, etc. The first code sent from the intercom will be stored in the memory and considered valid. After code initialisation, the 2N<sup>®</sup> Security Relay will pass into the operational mode (the green LED is blinking).

### Caution

- In case of resetting the factory default settings on a device with a version of firmware 2.18 or higher it is necessary to reprogram the 2N<sup>®</sup> Security Relay using the instructions above.

✔ Tip

- FAQ: 2N<sup>®</sup> Security Relay - what it is and how to use it with 2N IP intercom?

## Connection:

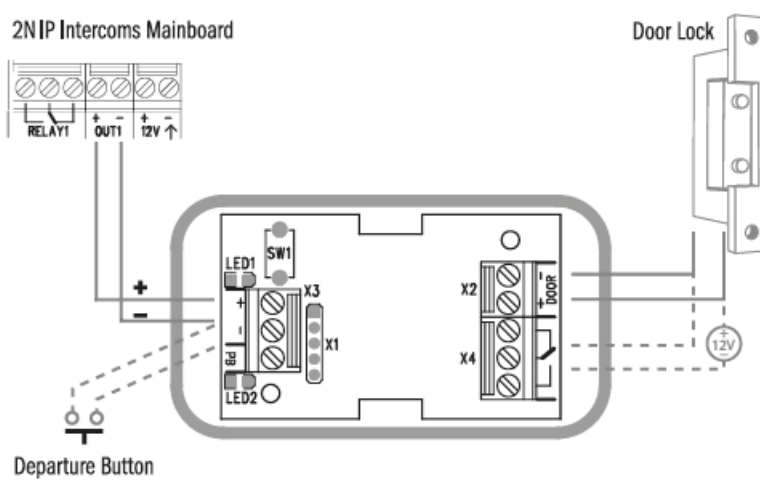

## Induction Loop

2N<sup>®</sup> Induction Loop (Part No. 9159050 - Induction loop amplifier for 2N IP intercom, Part No. 9159054 - Induction loop amplifier without 2N IP intercom accessory, Part No. 9159051 - External induction loop for wall mounting, Part No. 9159052 - 12 V DC power adapter) is part of sound system installations for hearing impaired persons that are equipped with a special hearing aid capable of receiving reproduced sound via a magnetic field receiver. The system is defined by the IEC 60118-4 standard.

## Installation:

The induction loop amplifier can be wall mounted with the use of an internal induction loop where a signal covering is requested. Outdoor use is possible thanks to the IP65 covering. A four-wire cable of the length of one meter is mounted to the supplied product for easier connection to the intercom. In the cable are two wires for 12 V DC supply and two wires for signal input, the wires are connected into interconnection connector. If you shorten the cable, follow the colour marking.

Before wall mounting run the cable through the hole that you have prepared. Then mark two mounting holes on the wall, through the amplifier front. Remove the amplifier and drill the mounting holes. Use the plugs and screws included in the delivery. Use a drill of the diameter of 6 mm. After fastening, cover the screws with the blanks supplied.

Use the supplied connectors to connect the amplifier to the intercom and power supply. The A connector is connected to the amplifier four-wire cable. Insert a special intercom-connecting cable supplied with the amplifier and 12 V power supply outlets to the B connector. Connect the special cable to the intercom and connect the power supply to the mains. You can place the mated A and B connectors into the 2N IP intercom cover. The connectors help you connect stripped cables. Open the connector by pushing a thin screwdriver onto the white spots at its front and close the connector by sliding the movable part through a side gap.

Finally, test the amplifier function using a suitable receiver for hearing impaired persons or magnetic field communication tester. No other settings are required.

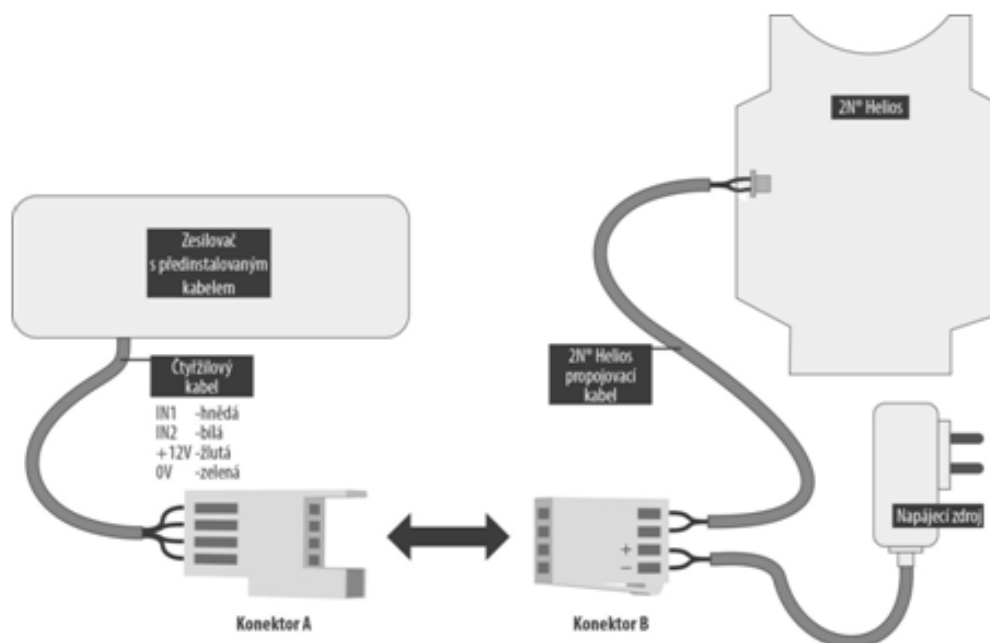

## Specifications:

- Supply voltage: 8 - 18VDC
- Supply current at 12 V supply:
  - 1  $\Omega$  load, full power output; 1.4 A, sine wave signal; 1 A, pink noise signal
  - 8  $\Omega$  load, half power output; 550 mA, sine wave signal; 400 mA, pink noise signal
  - no signal; 100 mA
  - standby; up to 10 mA



- Transition to standby w/o signal: 10 s
- Input level - basic: 100 mV - 6 V<sub>rms</sub>
- Input level - increased: 1 V - 35 V<sub>rms</sub>
- Input impedance: 2 kΩ parallel with 0.3 H
- Output current, 1 Ω load: 2.2 A<sub>rms</sub> (sine wave)
- Full power output: 1.6 A<sub>rms</sub> (pink noise)
- Output current, 8 Ω load: 730 mA<sub>rms</sub> sine wave signal
- Half power output: 520 mA<sub>rms</sub> pink noise signal
- Output short-circuit resistance: unlimited time
- Frequency characteristics: 100 Hz - 5 KHz ±3 dB
- Temperature range: -20 - +50 °C
- Covering: IP65 (with round cable of 5-10 mm diameter)
- Dimensions: 144 x 100 x 31 mm
- Weight: 0.3 kg

## 3. Function and Use

---

In this section we describe the basic and extending functions of the 2N<sup>®</sup> IP Safety product.

Here is what you can find in this section:

- **3.1 Configuration**
- **3.2 Maintenance**
- **3.3 Downloads**

## 3.1 Configuration

---

Use a PC equipped with any web browser to configure **2N<sup>®</sup> IP Safety**:

- Launch your web browser (Internet Explorer, Firefox, etc.).
- Enter the IP address of your intercom (<http://192.168.1.100/>, e.g.).
- Log in using the **Admin** user name and **2n** password.

You have to know the IP address of your device to log in to the integrated web server.

By default, **2N<sup>®</sup> IP Safety** is switched into the dynamic IP address mode, i.e. it obtains the IP address automatically if a properly set DHCP server is available in your LAN. If no such DHCP server is available, you can operate **2N<sup>®</sup> IP Safety** in the static IP address mode. Refer to the **Configuration manual for 2N IP intercoms for 2N<sup>®</sup> IP Safety** configuration details.

If your device remains inaccessible (you have forgotten the IP address, or the LAN configuration has changed, for example), change the LAN settings using the buttons on the device.

### IP Address Retrieval

Take the following steps to retrieve the **2N<sup>®</sup> IP Safety** IP address:

- Connect (or, if connected, disconnect and reconnect) **2N<sup>®</sup> IP Safety** to the power supply.
- Wait for the second sound signal .
- Press the quick dial button 5 times.
- **2N<sup>®</sup> IP Safety** will read its IP address.
- If the address is 0.0.0.0, it means that the intercom has not obtained the IP address from the DHCP server.



**Note**

- Be sure to press the button sequence within thirty seconds after the sound signal for security reasons. Up to 2 s intervals are allowed between the presses.

## Switching between Static and Dynamic IP Address

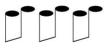
- Connect 2N<sup>®</sup> IP Safety to the power supply (or, disconnect and reconnect it if already connected).
- Wait for the first acoustic signal .
- Press the quick dial button 15 times.
- The acoustic signal  indicates mode switching.
- Wait until the device is restarted automatically.



**⚠ Caution**

- The 15 times 1 sequence must be entered within 30 seconds after the first sound signal for security reasons. The inter-digit delay may be 2 s at most.

The static IP address mode will be switched into the dynamic IP address mode and vice versa upon restart.

## 3.2 Maintenance

---

### Cleaning

If used frequently, the device surface gets dirty. To clean it, use a piece of soft cloth moistened with clean water. We recommend you to follow these principles while cleaning:

- Never use aggressive detergents (such as abrasives or strong disinfectants).
- Alcohol-based cleaners may be applied.
- Clean the device in dry weather in order to make waste water evaporate quickly.
- We recommend using cleaning wipes designed for IT / electronic items.

#### **Warning**

- Avoid peroxide-based cleaners.

#### **Tip**

- The 2N<sup>®</sup> IP Safety models of Part Nos. 9152101W, 9152102W and 9152101M W may be cleaned with WAP high pressure washers.

## Future Programming Changes

For necessary steps refer to the preceding subsections. Keep the following for future changes:

- This manual

### **Caution**

- Always use the product for the purpose it was designed and manufactured for, in compliance herewith.
- The manufacturer reserves the right to modify the product in order to improve its qualities.
- **2N<sup>®</sup> IP Safety** contains no environmentally harmful components. When the product's service life is exhausted and you would like to dispose of it please do so in accordance with applicable legal regulations.

---

## 3.3 Downloads

---

Software

2N<sup>®</sup> Network Scanner



---

## 4. Technical Parameters

---

### Signalling protocol

- SIP (UDP, TCP, TLS)

### Buttons

- **Button design:** Industrial waterproof, stainless steel, vandal resistant pushbutton, blue backlit
- **Count of buttons:** 1 (2 on request)
- **Numerical keypad:** (on request)

### Audio

- **Microphone:** 2 integrated microphones
- **Amplifier:** 10 W (class D)
- **Loudspeaker:** 10 W
- **Sound pressure level (SPL max):** 78.5 dB (1 W type, for 1 kHz, distance 1 m)
- **Sound pressure level (SPL max):** 94 dB (10 W type, for 1 kHz, distance 1 m)
- **Volume control:** Adjustable with automatic adaptive mode
- **Full duplex:** Yes (AEC)
- **Speech transmission index (STI):** 0.80

### Audio stream

- **Protocols:** RTP / RTSP
- **Codecs:** G.711, G.729, G.722, L16/16 kHz

### Video stream

- **Protocols:** RTP / RTSP / HTTP
- **Codecs:** H.263, H.263+, H.264, MPEG-4, M-JPEG
- **IP camera function:** Yes, ONVIF v2.4 profile S compatible

## Bandwidth

- **Audio codecs**

- PCMA, PCMU - 64 kbps (with 85.6 kbps headers)
- G.729 - 16 kbps (with 29.6 kbps headers)
- G.722 - 64 kbps (with 85.6 kbps headers)
- L16 / 16 kHz - 256 kbps (with 277.6 kbps headers)

- **V i d e o c o d e c s**

Set the video codec data flows in the Services / Phone / Video menu for calls and in the Services / Streaming / RTSP menu for streaming. The set bandwidth represents the value that the codec has to approach on a long-time average. The data flows can vary depending on the scene to be scanned.

The measured data flow values correspond to the test view of a person standing in front of the intercom.

- **H.264**

- Low quality: QVGA (320 x 240), 10 fps, 256 kbps: 181 kbps (with 190 kbps headers)
- Medium quality: VGA (640 x 480), 15 fps, 768 kbps: 600 kbps (with 661 kbps headers)
- High quality: VGA (640 x 480), 30 fps, 2048 kbps: 1319 kbps (with 1372 kbps headers)

- **MJPEG**

- Low quality: QVGA (320 x 240), 10 fps, quality 70: 435 kbps with headers
- Medium quality: VGA (640 x 480), 15 fps, quality 85: 506 kbps
- High quality: SXGA (1280 x 960), 15 fps, quality 95: 8 Mbps

## Interface

- **Power supply:** 12 V  $\pm$ 15 % / 2 A DC or PoE
- **PoE:** PoE 802.3af (Class 0-12.95 W)
- **LAN:** 10/100BASE-TX s Auto-MDIX, RJ-45
- **Recommended cabling:** Cat-5e or higher
- **Supported protocols:** SIP2.0, DHCP opt. 66, SMTP, 802.1x, RTSP, RTP, TFTP, HTTP, HTTPS, Syslog, ONVIF
- **Passive switch:** NO and NC contacts, up to 30 V / 1 A AC/DC
- **Active switch output:** 9 up to 13 V DC depending on power supply (PoE: 9 V; adaptor: power supply voltage minus 1 V), max 600 mA

## Additional switch

- **Optional**
  - Includes also one input, active output, relay, tamper switch
- **Passive switch:** NO and NC contacts, up to 30 V / 1 A AC/DC
- **Active switch output:** 9 up to 13 V DC depending on power supply (PoE: 9 V; adaptor: power supply voltage minus 1 V), max 600 mA

## Mechanical properties

- **Cover:** Robust aluminium cast product
- **Colour:** RAL 2004 orange
- **Working temperature:** -40 °C to 55 °C
- **Working relative humidity:** 10 % - 95 % (non-condensing)
- **Storing temperature:** -40 °C to 70 °C
- **Dimensions**
  - 217 x 109 x 83 mm
  - 242 x 136 x 83 mm incl. frame
- **Weight:** netto max. 2 kg / brutto max. 2,5 kg
- **Covering level:** IP65 , IP69K (91521xxxW)
- **Resistance level:** IK10

## UL294 levels

- Attack, Security, Line Security - Level I
- Endurance - Level IV

## 4.1 General drawings

### Surface mounting

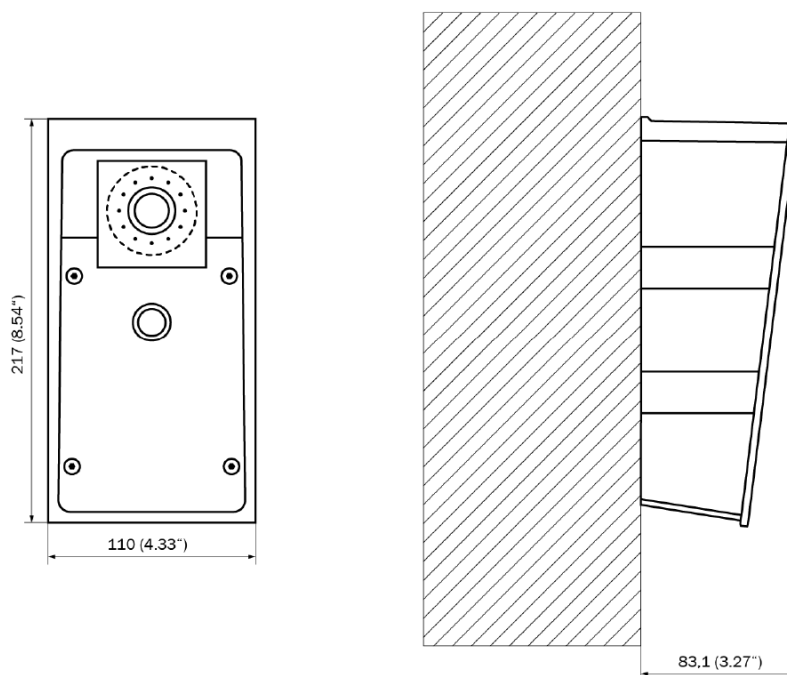

## Flush mounting

### Plasterboard mounting

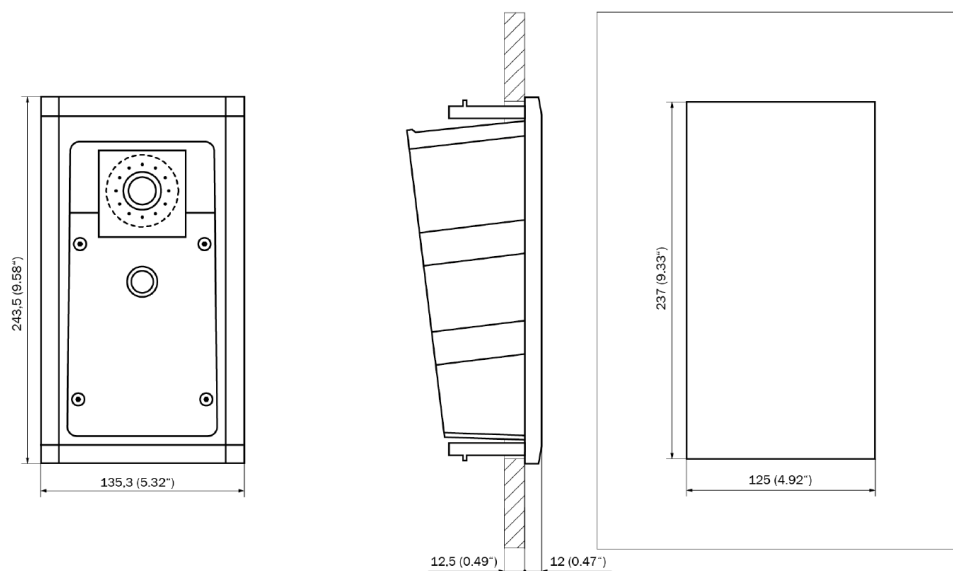

### Flush mounting with box

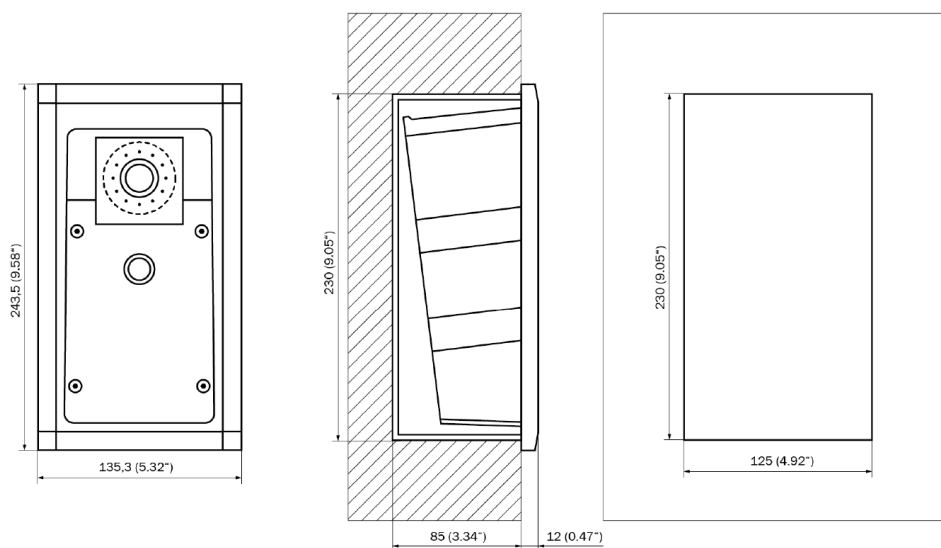

## 5. Supplementary Information

---

Here is what you can find in this section:

- 5.1 Troubleshooting
- 5.2 Directives, Laws and Regulations
- 5.3 General Instructions and Cautions

---

## 5.1 Troubleshooting

---



For the most frequently asked questions refer to [faq.2n.cz](http://faq.2n.cz).

---

## 5.2 Directives, Laws and Regulations

---

2N<sup>®</sup> IP Safety conforms to the following directives and regulations:

- 2014/35/EU for electrical equipment designed for use within certain voltage limits
- 2014/30/EU for electromagnetic compatibility
- 2011/65/EU on the restriction of the use of certain hazardous substances in electrical and electronic equipment
- 2012/19/EU on waste electrical and electronic equipment

### Industry Canada

This Class B digital apparatus complies with Canadian ICES-003/NMB-003.

### FCC

This equipment has been tested and found to comply with the limits for a Class B digital device, pursuant to part 15 of the FCC Rules.

NOTE: These limits are designed to provide reasonable protection against harmful interference in a residential installation. This equipment generates, uses and can radiate radio frequency energy and, if not installed and used in accordance with the instructions, may cause harmful interference to radio communications.

However, there is no guarantee that interference will not occur in a particular installation. If this equipment does cause harmful interference to radio or television reception, which can be determined by turning the equipment off and on, the user is encouraged to try to correct the interference by one or more of the following measures:

- Reorient or relocate the receiving antenna
- Increase the separation between the equipment and receiver
- Connect the equipment into an outlet on a circuit different from that to which the receiver is connected
- Consult the dealer or an experienced radio/TV technician for help

Changes or modifications to this unit not expressly approved by the party responsible for compliance could void the user's authority to operate this equipment.



 **Caution****Warning**

In order to ensure the full functioning and guaranteed outputs we strongly recommend a verification of the timeliness of version of product or facility already during the installation process. The customer takes into consideration that the product or facility can achieve the guaranteed outputs and be fully operational pursuant to the producer's instructions only by using the most recent version of product or facility, which has been tested for full interoperability and has not been determined by the producer as incompatible with certain versions of other products, only in conformity with the producer's instructions, guidelines, manual or recommendation and only in conjunction with suitable products and facilities of the other producers. The most recent versions are available on the website [https://www.2n.cz/cs\\_CZ/](https://www.2n.cz/cs_CZ/), or specific facilities, depending on their technical capacity, allow updating in the configuration interface. Should the customer use any other version of product or facility than the most recent one, or the version that has been determined by the producer as incompatible with certain versions of other producers' products of facilities, or the product or facility in a way incompatible with the producer's instructions, guidelines, manual or recommendation or in conjunction with unsuitable products or facilities of the other producers, he or she is aware of all potential limitations of functionality of such a product or facility and all relating consequences. Should the customer use any other than the most recent version of the product or facility, or the version that has been determined by the producer as incompatible with certain versions of other producers' products of facilities, or the product or facility in a way incompatible with the producer's instructions, guidelines, manual or recommendation or in conjunction with unsuitable products or facilities of the other producers, he or she agrees that the company 2N TELEKOMUNIKACE a. s. is not liable neither for any limitation of such a product's functionality, nor for any damage, loss or injury relating to such a potential limitation of functionality.

---

## 5.3 General Instructions and Cautions

---

Please read this User Manual carefully before using the product. Follow all instructions and recommendations included herein.

Any use of the product that is in contradiction with the instructions provided herein may result in malfunction, damage or destruction of the product.

The manufacturer shall not be liable and responsible for any damage incurred as a result of a use of the product other than that included herein, namely undue application and disobedience of the recommendations and warnings in contradiction herewith.

Any use or connection of the product other than those included herein shall be considered undue and the manufacturer shall not be liable for any consequences arisen as a result of such misconduct.

Moreover, the manufacturer shall not be liable for any damage or destruction of the product incurred as a result of misplacement, incompetent installation and/or undue operation and use of the product in contradiction herewith.

The manufacturer assumes no responsibility for any malfunction, damage or destruction of the product caused by incompetent replacement of parts or due to the use of reproduction parts or components.

The manufacturer shall not be liable and responsible for any loss or damage incurred as a result of a natural disaster or any other unfavourable natural condition.

The manufacturer shall not be held liable for any damage of the product arising during the shipping thereof.

The manufacturer shall not make any warrant with regard to data loss or damage.

The manufacturer shall not be liable and responsible for any direct or indirect damage incurred as a result of a use of the product in contradiction herewith or a failure of the product due to a use in contradiction herewith.

All applicable legal regulations concerning the product installation and use as well as provisions of technical standards on electric installations have to be obeyed. The manufacturer shall not be liable and responsible for damage or destruction of the product or damage incurred by the consumer in case the product is used and handled contrary to the said regulations and provisions.

The consumer shall, at its own expense, obtain software protection of the product. The manufacturer shall not be held liable and responsible for any damage incurred as a result of the use of deficient or substandard security software.

The consumer shall, without delay, change the access password for the product after installation. The manufacturer shall not be held liable or responsible for any damage incurred by the consumer in connection with the use of the original password.

The manufacturer also assumes no responsibility for additional costs incurred by the consumer as a result of making calls using a line with an increased tariff.

## **Electric Waste and Used Battery Pack Handling**



Do not place used electric devices and battery packs into municipal waste containers. An undue disposal thereof might impair the environment!

Deliver your expired electric appliances and battery packs removed from them to dedicated dumpsites or containers or give them back to the dealer or manufacturer for environmental-friendly disposal. The dealer or manufacturer shall take the product back free of charge and without requiring another purchase. Make sure that the devices to be disposed of are complete.

Do not throw battery packs into fire. Battery packs may not be taken into parts or short-circuited either.



**2N TELEKOMUNIKACE a.s.**

Modřanská 621, 143 01 Prague 4, Czech Republic

Phone: +420 261 301 500, Fax: +420 261 301 599

E-mail: [sales@2n.cz](mailto:sales@2n.cz)

Web: [www.2n.cz](http://www.2n.cz)

v2.14