

Installation manual 2N[®] IP Base

2N

Content:

- 1. Product Overview
 - 1.1 Components and Associated Products
 - 1.2 Terms and Symbols
- 2. Description and Installation
 - 2.1 Before You Start
 - 2.2 Mechanical Installation
 - 2.3 Electric Installation
 - 2.3.1 Overvoltage Protection
 - 2.4 Extending Module Connection
 - 2.5 Completion
- 3. Function and Use
 - 3.1 Configuration
 - 3.2 Intercom Control as Viewed by External User
 - 3.3 Intercom Control as Viewed by Internal User
 - 3.4 Maintenance
 - 3.5 Downloads
- 4. Technical Parameters
 - 4.1 General drawings
- 5. Supplementary Information
 - 5.1 Troubleshooting
 - 5.2 Directives, Laws and Regulations
 - 5.3 Other Countries' Legislation
 - 5.4 General Instructions and Cautions

1. Product Overview

Here is what you can find in this section:

- [1.1 Components and Associated Products](#)
- [1.2 Terms and Symbols](#)

Basic Features

2N® IP Base – is an elegant and reliable intercom equipped with lots of useful functions. Thanks to SIP support and compatibility with major brands of PBX manufacturers, it can benefit from using VoIP networks. **2N® IP Base** can be used as a door or special purpose intercom for office buildings, residential areas and other applications.

Wide angle HD camera – allows the tenant to see the calling person on his or her videophone or PC screen in high resolution.

Quick dial buttons – there are 2 quick dial buttons in total. For each button, up to three separate phone numbers plus substitute users can be defined, which ensures that the called user is reached whenever needed. The buttons are backlit with a clear mechanical response. The nametag surface is scratch resistant.

RFID card reader – the card reader module brings the access control functionality according to the RFID card or keyfob. With the advanced features, other functions can be RFID card controlled too.

Electric lock control – as part of the access system, the electrical lock can be controlled by a code entered on the keypad or the called phone, with the RFID card, via a PC application, etc. Numerous parameters allow for a wide spectrum of applications.

Robustness – **2N® IP Base** is designed as a vandal resistant intercom, which withstands mechanical or weather conditions with no need to purchase extra accessories.

Audio quality – using the automatic echo cancelling system, full duplex communication is available at any time.

The installation of 2N® IP Base – is very easy, all you have to do to attach the network cable. The intercom can be supplied from a 12 V DC power source, or using a PoE switch.

Use your PC with any internet browser to configure **2N® IP Base** or apply the **2N® Access Commander** to configure extensive installations of multiple intercoms.

Advantages of Use

- Elegant design
- Weather resistant
- Sensitive microphone and loud speaker
- Both-way audio communication – acoustic echo cancellation
- Integrated colour HD camera with wide-angle lense and hidden night vision
- Selectable number of quick dial buttons (one or two) with name tags and backlight
- Integrated switches of electric locks with wide setting options
- Optional integrated RFID card reader module
- PoE or 12 V DC power supply
- Configuration using web interface or dedicated PC application
- VoIP standard SIP 2.0 support
- 10 000 Phone Book positions
- 20 user time profiles
- Video codecs (H.263, H.263+, H.264, MJPEG)
- Audio codecs (G.711, G.722)
- NTP client for time synchronisation

1.1 Components and Associated Products

Main Units

2N Part No. 9156111CB
Axis Part No. 01357-001



- Main unit **2N® IP Base**
- Standalone compact unit is expandable with an RFID reader.
- We recommend to use the mounting backplate on an uneven surface.
- Exposure to direct sunlight is not recommended.

⚠ Caution

- The only possible installation of **2N® IP Base** is on surface.

Mounting backplate

2N Part No. 9156020
Axis Part No. 01360-001



- **2N® IP Base** – mounting backplate
- Mounting backplate for main unit **2N® IP Base**
- Optional, recommended for mounting on uneven surfaces (inequalities bigger than 2mm)

2N® IP Base is designed for outdoor use and requires no additional roof.

Expansion modules

2N Part No. 9156030
Axis Part No. 01358-001

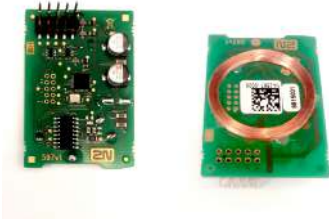

- **2N® IP Base** – RFID Card Reader, 125 kHz
- The card reader module provides you with access control via contactless cards or keyfobs. The module supports the 125 kHz cards:
 - EM4xxx

2N Part No. 9156031
Axis Part No. 01359-001



- **2N® IP Base** – RFID Card Reader, 13.56 MHz, NFC/HCE
- The card reader module provides you with access control via contactless cards or keyfobs. The module supports the following 13.56 MHz cards or other carriers (only card serial number is read):
 - ISO14443A (MIFARE DESFire)
 - PicoPass (HID iClass)
 - FeliCa
 - ST SR(IX)
 - 2N® Mobile Key

2N Internal Units and Accessories

Part Numbers:
2N Part No. 91378375
Axis Part No. 01668-001
2N Part No. 91378376
Axis Part No. 01670-001



- **2N® Indoor Touch 2.0** – black
- WiFi version (second part no.)
- The elegant internal touch panel, **2N® Indoor Touch 2.0**, is suitable for all **2N IP intercoms**. On the panel's display not only can you find out who is at the door, but also start a conversation with the visitor, open the lock or turn on the light in the entrance hall.

2N Part No. 91378382

Axis Part No. 01425-001



- **2N® Indoor Touch** desk stand black

Part Numbers:

2N Part No. 91378375WH

Axis Part No. 01669-001

2N Part No. 91378376WH

Axis Part No. 01671-001



- **2N® Indoor Touch 2.0** – white
- WiFi version (second part no.)
- The elegant internal touch panel **2N® Indoor Touch 2.0** is suitable for all **2N IP intercoms**. On the panel's display not only can you find out who is at the door, but also start a conversation with the visitor, open the lock or turn on the light in the entrance hall.

2N Part No. 91378382W

Axis Part No. 01426-001



- **2N® Indoor Touch** desk stand white

**2N Part No.
1120101W**

**Axis Part No.
02518-001**



- **2N® IP Handset**
- answering unit
- white color

**2N Part No.
1120101B**

**Axis Part No.
02519-001**



- **2N® IP Handset**
- answering unit
- black color

IP Phones

2N Part No. 1120102
Axis Part No. 02660-001



- **2N® IP Phone D7A**
- simple operation
- HD quality video calls
- A display-equipped extender EXP50 (Part No. **91378363**) can be added to the phone delivery to make up to 60 speed dialings.

2N Part No. 1120111EU
Axis Part No. 02544-001



- **Grandstream GXV3350 IP video phone**
- Android 7.0 OS
- 5" touch display control
- HD quality video calls
- WiFi and Bluetooth support
- HDMI output and pan tilt zoom camera
- Easy integration with intercoms or PBXs via SIP



Electric Locks



| | |
|--|---|
| <p>Part No. 11202101</p>  | <ul style="list-style-type: none"> • Mini electronic doorstrike series 5 • electric opener designed for door frame installation • intended for such narrow profiles as aluminum, wood or PVC in particular • short sheet metal front cover version (130 mm) • 16 mm width |
| <p>Part No. 11202101-L</p>  | <ul style="list-style-type: none"> • Mini electronic doorstrike series 5 – long • electric opener designed for door frame installation • intended for such narrow profiles as aluminum, wood or PVC in particular • long sheet metal front cover version (250 mm) • 16 mm width |
| <p>Part No. 11202102</p>  | <ul style="list-style-type: none"> • Mini electronic doorstrike series 5 – with momentum pin • electric opener designed for door frame installation • intended for such narrow profiles as aluminum, wood or PVC in particular • short sheet metal front cover version (130 mm) • 16 mm width |



| | |
|---|---|
| <p>Part No. 11202102-L</p>  | <ul style="list-style-type: none"> • Mini electronic doorstrike series 5 – with momentum pin, long • electric opener designed for door frame installation • intended for such narrow profiles as aluminum, wood or PVC in particular • long sheet metal front cover version (250 mm) • 16 mm width |
| <p>Part No. 11202103</p>  | <ul style="list-style-type: none"> • Mini electronic doorstrike series 5 – with mechanical blocking • electric opener designed for door frame installation • intended for such narrow profiles as aluminum, wood or PVC in particular • short sheet metal front cover version (130 mm) • 16 mm width |
| <p>Part No. 11202103-L</p>  | <ul style="list-style-type: none"> • Mini electronic doorstrike series 5 – with mechanical blocking, long • electric opener designed for door frame installation • intended for such narrow profiles as aluminum, wood or PVC in particular • long sheet metal front cover version (250 mm) • 16 mm width |

| | |
|--|--|
| <p>Part No. 11202104</p>  | <ul style="list-style-type: none"> • Mini electronic doorstrike series 5 – door signaling • electric opener designed for door frame installation • intended for such narrow profiles as aluminum, wood or PVC in particular • including a door state monitoring micro switch: open/closed • short sheet metal front cover version (130 mm) • 16 mm width |
| <p>Part No. 11202104-L</p>  | <ul style="list-style-type: none"> • Mini electronic doorstrike series 5 – door signaling, long • electric opener designed for door frame installation • intended for such narrow profiles as aluminum, wood or PVC in particular • including a door state monitoring micro switch: open/closed • long sheet metal front cover version (250 mm) • 16 mm width |
| <p>Part No. 11202105</p>  | <ul style="list-style-type: none"> • Mini electronic doorstrike series 5 – fail-safe • electric opener designed for door frame installation • intended for such narrow profiles as aluminum, wood or PVC in particular • under voltage: opener secured, blocked • at voltage interruption: opener unblocked, door can be opened • short sheet metal front cover version (130 mm) • 16 mm width |

| | |
|---|--|
| <p>Part No. 11202105-L</p>  | <ul style="list-style-type: none"> • Mini electronic doorstrike series 5 – fail-safe, long • electric opener designed for door frame installation • intended for such narrow profiles as aluminum, wood or PVC in particular • under voltage: opener secured, blocked • at voltage interruption: opener unblocked, door can be opened • long sheet metal front cover version (250 mm) • 16 mm width |
| <p>Part No. 11202106</p>  | <ul style="list-style-type: none"> • Mini electronic doorstrike series 5 – fail-safe and door signaling • electric opener designed for door frame installation • intended for such narrow profiles as aluminum, wood or PVC in particular • under voltage: opener secured, blocked • at voltage interruption: opener unblocked, door can be opened • short sheet metal front cover version (130 mm) • 16 mm width |
| <p>Part No. 11202106-L</p>  | <ul style="list-style-type: none"> • Mini electronic doorstrike series 5 – fail-safe and door signaling, long • electric opener designed for door frame installation • intended for such narrow profiles as aluminum, wood or PVC in particular • under voltage: opener secured, blocked • at voltage interruption: opener unblocked, door can be opened • long sheet metal front cover version (250 mm) • 16 mm width |

| | |
|--|---|
| <p>Part No. 11202201</p>  | <ul style="list-style-type: none"> • Electromechanical lock SAM 7255 • 72/55 self-locking lock with panic function • A key is necessary for door opening from the outside (or an electric pulse from a connected 2N IP intercom / reader). • convenient solution for emergency exits |
| <p>Part No. 11202201-M</p>  | <ul style="list-style-type: none"> • Electromechanical lock SAM 7255 with monitoring • 72/55 self-locking lock with panic function • A key is necessary for door opening from the outside (or an electric pulse from a connected 2N IP intercom / reader). • convenient solution for emergency exits |
| <p>Part No. 11202202</p>  | <ul style="list-style-type: none"> • Electromechanical lock SAM 9235 • 92/35 self-locking lock with panic function • A key is necessary for door opening from the outside (or an electric pulse from a connected 2N IP intercom / reader). • convenient solution for emergency exits |

| | |
|---|---|
| <p>Part No. 11202202-M</p>  | <ul style="list-style-type: none"> • Electromechanical lock SAM 9235 with monitoring • 92/35 self-locking lock with panic function • A key is necessary for door opening from the outside (or an electric pulse from a connected 2N IP intercom / reader). • convenient solution for emergency exits |
| <p>Part No. 11202301</p>  | <ul style="list-style-type: none"> • Cable protector FX290 • Provides secure passage and protection of the supply cable between the door frame and the door leaf. • 290 mm length |
| <p>Part No. 11202302</p>  | <ul style="list-style-type: none"> • Cable protector FX510 • Provides secure passage and protection of the supply cable between the door frame and the door leaf. • 510 mm length |

| | |
|---|---|
| <p>Part No. 11202303</p>  | <ul style="list-style-type: none"> • Cable protector FX300G • Provides secure passage and protection of the supply cable between the door frame and the door leaf. • 440 mm length |
| <p>Part No. 11202304</p>  | <ul style="list-style-type: none"> • Cable protector FX500G • Provides secure passage and protection of the supply cable between the door frame and the door leaf. • 640 mm length |
| <p>Part No. 11202203</p> | <ul style="list-style-type: none"> • Supply cable with 14-core connector • 6000 mm length • Conductor cross section: 14 × 0.22 mm • Terminated with a connector on one side • Designed for 11202201-M and 11202202-M locks |
| <p>Part No. 11202107</p>  | <ul style="list-style-type: none"> • Maglock MEX100 • used as a door holding supplement, not replacing the lock • consists of two parts: supplied part and counterpart • under voltage: door cannot be opened • at voltage interruption: magnets get disconnected, door opens |

Part No. 11202501



- **Magnetic handle P300RP**
- fully replaces a mortise lock and handle
- under voltage: door cannot be opened
- at voltage interruption: magnets get disconnected, door opens
- suitable for wooden, metal and glass doors

Part No. 11202401





- **ED100**
- low energy simple door operator
- contactless operation
- can be interconnected with a motion sensor and electronic access control system
- applicable for right / left doors
- in / out opening versions

✓ **Tip**

- FAQ: [Electric locks – Difference between locks in 2N IP intercoms accesories](#)

Power Supply

| | |
|--|---|
| <p>Part Numbers:</p> <p>2N Part No. 91378100E</p> <p>2N Part No. 91378100US</p> <p>Axis Part No. 01403-001</p>  | <ul style="list-style-type: none"> • PoE injector – with EU cable • PoE injector – with US cable • For power supply of intercom via ethernet cable when PoE switch is not available. |
| <p>Part No. 91341481E</p>  | <ul style="list-style-type: none"> • Stabilised 12 V / 2 A power supply needs to be used when no PoE is available. |
| <p>Part No. 932928</p>  | <ul style="list-style-type: none"> • 12 V transformer • For 230 V mains voltage. • For external power supply of the lock with 12 V AC voltage. |

Two-wire connection

2N Part No. 9159014EU/UK

2N Part No. 9159014US

Axis Part No. 01404-001



- **2N® 2Wire**
- (set of 2 adaptors and power source for EU/US/UK)
- The **2N® 2Wire** converter allows you to use existing wiring (2 wires) from your original door bell or door intercom to connect any IP device. You don't have to configure anything, and you only need one **2N® 2Wire** unit at each end of the cable and a power source connected to at least one of these units. The **2N® 2Wire** unit then provides PoE power not only to the second converter, but also to all other connected IP end devices.

RFID 13 MHz

2N Part No. 9137421E

Axis Part No. 01400-001



- **Ext. RFID Reader 13.56 MHz, 125 kHz + NFC/HCE (USB interface)**
- External RFID card reader for connection to PC using a USB interface. Suitable for system administration and adding 13.56 MHz, 125 kHz cards and Android platform devices supporting NFC/HCE using **2N IP intercom** web interface or the **2N® Access Commander** application. Suitable for MIFARE DESFire card upload to the **2N® PICard Commander** encryption application. It reads the same types of cards and devices as card readers in **2N IP intercoms**:
 - **125 kHz**
 - EM4xxx
 - **13.56 MHz**
 - ISO14443A (MIFARE DESFire)
 - PicoPass (HID iClass)
 - FeliCa
 - ST SR(IX)

2N Part No. 9137424E

Axis Part No. 01527-001





- **Ext. secured RFID Reader 13.56 MHz, 125 kHz + NFC/HCE (USB interface)**
- External secured RFID card reader for connection to PC using a USB interface. Suitable for system administration and adding 13.56 MHz, 125 kHz cards and Android platform devices supporting NFC/HCE using **2N IP intercom** web interface or the **2N® Access Commander** application. Suitable for MIFARE DESFire card upload to the **2N® PICard Commander** encryption application. It reads the same types of cards and devices as card readers in **2N IPintercoms**.
 - **125 kHz**
 - EM4xxx
 - HID Prox
 - **13.56 MHz**
 - ISO14443A (MIFARE DESFire)
 - PicoPass (HID iClass)
 - FeliCa
 - ST SR(IX)
 - 2N® Mobile Key
 - HID SE (Seos, iClass SE, MIFARE SE)

2N Part No. 9134173

Axis Part No. 01384-001

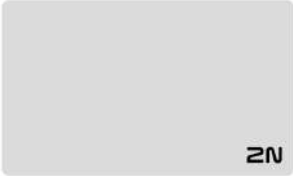

- **MIFARE Classic**, 1k RFID card, 13.56 MHz

| | |
|--|---|
| <p>2N Part No. 9134174 Axis Part No. 01385-001</p>  | <ul style="list-style-type: none">• MIFARE Classic. 1k RFID fob, 13.56 MHz |
| <p>Part No. 11202601 Axis Part No. 02787-001</p>  | <ul style="list-style-type: none">• 2N® RFID card Mifare Desfire EV3 4K 13.56MHz 10 pcs• 10 pcs per package• MIFARE DESFire EV3 (ISO/IEC14443A)• Suitable for data encryption in 2N® PICard Commander. |
| <p>Part No. 11202602 Axis Part No. 02788-001</p>  | <ul style="list-style-type: none">• 2N® RFID fob Mifare Desfire EV3 4K 13.56MHz 10 pcs• 10 pcs per package• MIFARE DESFire EV3 (ISO/IEC14443A)• Suitable for data encryption in 2N® PICard Commander. |

RFID 125 kHz

2N Part No. 9159030
Axis Part No. 01389-001





- External 125 kHz RFID card reader
- Secondary reader for connection to an internal reader. Allows for card entry control from both sides of the door. IP67 cover, also suitable for exteriors. Reads EM4xxx cards.

2N Part No. 9137420E
Axis Part No. 01399-001





- USB RFID card reader 125 kHz
- External RFID card reader for connection to a PC using a USB interface. Suitable for system management and the addition of EM41xx cards via the PC application, **2N® Access Commander**.

| | |
|--|--|
| <p>2N Part No. 9134165E Axis Part No. 01395-001</p>  | <ul style="list-style-type: none"> • RFID card, type EM4100, 125 kHz |
| <p>2N Part No. 9134166E Axis Part No. 01396-001</p>  | <ul style="list-style-type: none"> • RFID fob, type EM4100, 125 kHz |

External switches

| | |
|--|--|
| <p>2N Part No. 9159010 Axis Part No. 01386-001</p>  | <ul style="list-style-type: none"> • 2N® Security Relay • A handy add-on that significantly enhances door entry security as it prevents tampering with the intercom and forced opening of the lock. To be installed between intercom and lock, powered by the intercom. |
|--|--|

| | |
|--|--|
| <p>2N Part No. 9137410E Axis Part No. 01397-001</p>  | <ul style="list-style-type: none"> • External IP Relay – 1 output • Standalone IP device which can be controlled by HTTP commands sent by 2N IP intercom, which can thus control devices on unlimited distance. |
| <p>2N Part No. 9137411E Axis Part No. 01398-001</p>  | <ul style="list-style-type: none"> • External IP Relay – 4 outputs, PoE • Standalone IP device which can be controlled by HTTP commands sent by 2N IP intercom, which can thus control devices on unlimited distance. |

Sensors and switches

| | |
|--|---|
| <p>Part No. 9159013</p>  | <ul style="list-style-type: none"> • Exit button • A button for connection to a logic input for opening a door inside a building. |
|--|---|

| | |
|--|--|
| <p>2N Part No. 9159012 Axis Part No. 01388-001</p>  | <ul style="list-style-type: none"> • Magnetic door contact • Set for installation on a door, enabling the status of door opening to be ascertained. Used when the intercom is used for door protection, to detect when the door is not |
|--|--|

License

| | |
|--|--|
| <p>2N Part No. 9137909</p> | <ul style="list-style-type: none"> • Gold • Includes Enhanced Video, Enhanced Integration and Lift Control licenses |
| <p>2N Part No. 9137910 Axis Part No. 01381-001</p> | <ul style="list-style-type: none"> • InformaCast |

✔ **Tip**

- Refer to the Configuration Manual for 2N IP intercoms, Subs. [3.2 Function Licensing](#) for details.

✔ **Tip**

- For more accessories and particular advice please contact your local distributor of 2N products.

1.2 Terms and Symbols

The following symbols and pictograms are used in the manual:

Safety

- **Always abide** by this information to prevent persons from injury.

Warning

- **Always abide** by this information to prevent damage to the device.

Caution

- **Important information** for system functionality.

Tip

- **Useful information** for quick and efficient functionality.

Note

- Routines or advice for efficient use of the device.

2. Description and Installation

Here is what you can find in this section:

- [2.1 Before You Start](#)
- [2.2 Mechanical Installation](#)
- [2.3 Electric Installation](#)
- [2.4 Extending Module Connection](#)
- [2.5 Completion](#)

2.1 Before You Start

Product Completeness Check

Before you start please check whether the contents of the package of your new **2N® IP Base** complies with the following list:

- **2N® IP Base**
- Manual
- Films for labels
- Double-ended wrench – Torx
- Double-button
- Screws and dowels
- Metal pads
- Certificate of ownership



2.2 Mechanical Installation

Surface Mounting

What you need for mounting:

- **2N® IP Base** plus appropriate frames
- LAN connection, UTP Cat5e or better with RJ-45 connector
- 802.3af PoE or 12 V DC / 2 A power supply

Before using this product, please read the instruction manual and follow the instructions and recommendations contained therein.

Installation procedure:

- Choose a location easily accessible to users.
- As the intercom is black, do not install it in direct sunlight to avoid overheating.
- Verify the cable connecting options – the device has two grommets towards the wall at the bottom.
- Prepare the cables connected to the LAN as well as the power supply and line to the lock or other accessories if necessary.
- Remove the metal frame of the device, open the lower blank module as pointed by the arrows and insert all the cables. Put the cables through the grommets. The manufacturer is not liable for defects caused by loss due to insufficient sealing.
- Fit the device to the backplate. You can use a drilling template; download [here](#).
- Plug in the cables, check the functionality of the device.
- Replace the blank module and attach the frame.
- The figures below show frame demounting and position of the mounting screws.

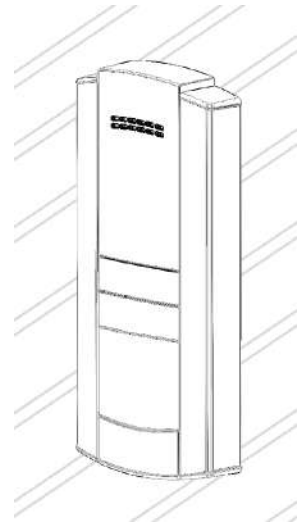

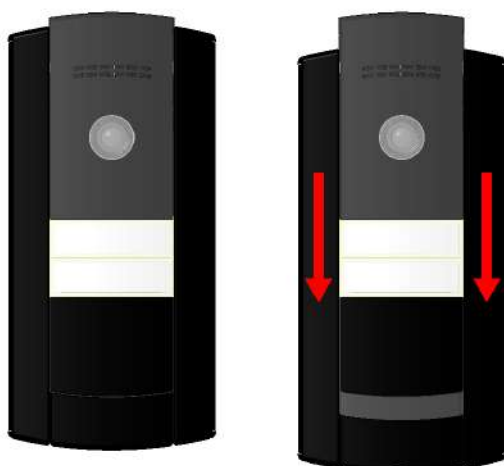

Frame Demounting. First use the torx handle enclosed to remove the screw that fits the frame to the **2N® IP Base** structure.



Position of Mounting Screws on **2N® IP Base**

The device is intended for surface mounting, for this type of installation the device itself is sufficient. A mounting backplate can be used (**Part. No. 9156020**) for uneven surfaces and easier installation. For mounting backplate installation, follow the mounting backplate instructions.

⚠ Caution

- After removing the front end cap at the lower part of the intercom make sure that there is no dirt on gaskets and connectors.
- The warranty does not apply to the product defects and failures arisen as a result of improper mounting (in contradiction herewith). The manufacturer is neither liable for damage caused by theft within an area that is accessible after the attached electric lock is switched. The product is not designed as a burglar protection device except when used in combination with a standard lock, which has the security function.
- When the proper mounting instructions are not met, water might get in and destroy the electronics. It is because the communicator circuits are under continuous voltage and water infiltration causes an electro-chemical reaction. The manufacturer's warranty shall be void for products damaged in this way!

Mounting Principles

⚠ Caution

- Before starting the mechanical installation on a selected place, make sure carefully that the preparations connected with it (drilling, wall cutting) cannot damage the electrical, gas, water and other existing wires and pipes.
- Make sure that the diameter of the dowel holes is accurate to avoid falling out of the dowels! Use the mounting glue to secure the dowels if necessary. Make sure that the depth of the dowel holes is accurate! Do not use low-quality dowels to avoid their pulling out of the wall!
- Never turn **2N® IP Base** to align the box assembly after mounting. Make sure that the flush mounting boxes have been installed accurately.
- Make sure that the surface mounting place is perfectly flat with the maximum inequality of 2 mm (e.g. desk materials, glass, cut stone etc.). If the place is not flat, use mounting backplate **Part No. 9156020** or equal the wall surface.

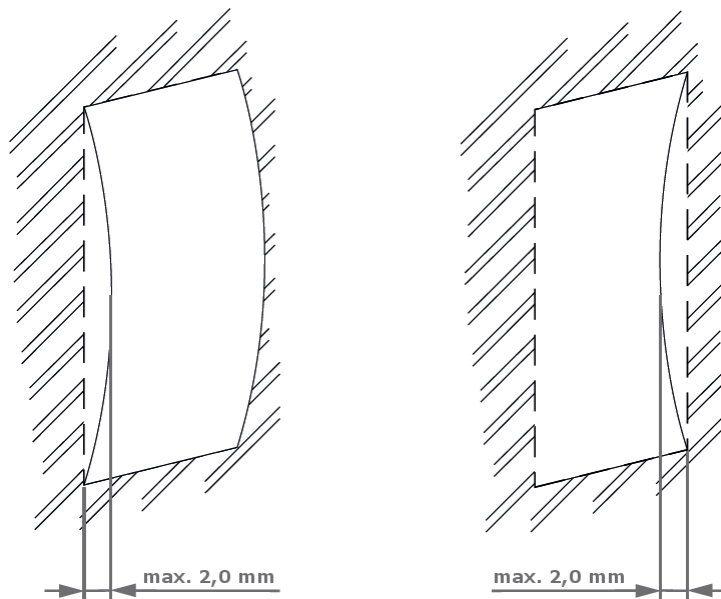

2.3 Electric Installation

Static IP Address Setting This subsection describes how to connect the **2N IP Base** main unit to the power supply and LAN and how to connect other elements. Connection of RFID reader modules is contained in section [2.4 Extending Module Connection](#).

⚠ Caution

- The device must be part of the electrical system of the building.

Main Unit Connector Configuration

Description board connectors accessible to users:

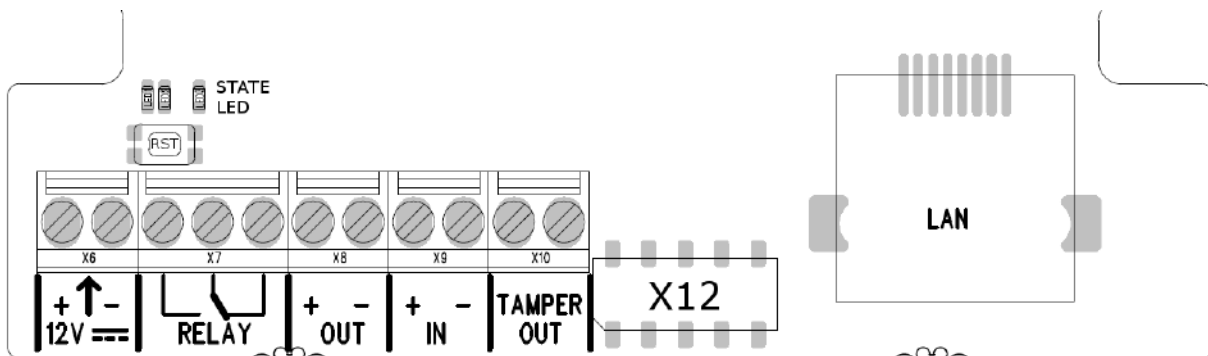

| Legend | |
|---------------|--|
| LAN (PoE) | LAN (PoE according to 802.3af) connector |
| X12 Connector | The connector for RFID Reader modules |
| Tamper | Output of internal security intercom contact |
| IN | Terminals for input in passive / active mode (-30 V to +30 V DC) <ul style="list-style-type: none"> • OFF = open OR $U_{IN} > 1.5\text{ V}$ • ON = closed contact OR $U_{IN} < 1.5\text{ V}$ |
| OUT | OUT1 active output: 8 up to 12 V DC depending on power supply (PoE: 10 V; adaptor: power supply voltage minus 2 V), max 600 mA |
| RELAY | Terminal 30 V / 1 A AC/DC NO/NC contact. Used for connection of non-critical devices only (lights, e.g.). |
| 12V | External 12 V / 2 A DC power supply terminals |
| RESET (RST) | RESET / FACTORY RESET button |
| LED | LED indicators (red – device state / green – eth. link up / yellow – LAN activity) |

- Output wiring diagram for Relay terminals

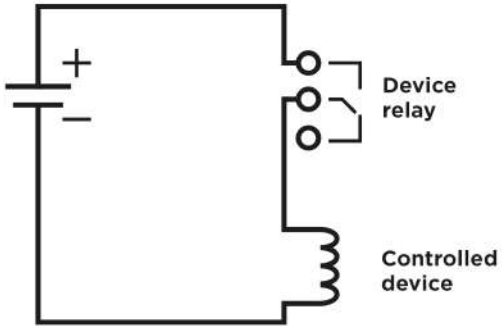

Wiring diagram for the controlled device's electric circuit closing

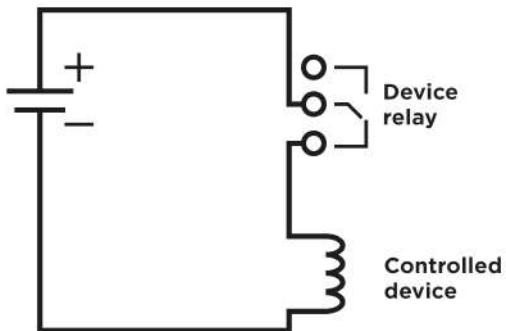

Wiring diagram for the controlled device's electric circuit opening

✓ **Tip**

- Wiring Diagram of IN1 connector in active mode



- Wiring Diagram of IN1 connector in passive mode

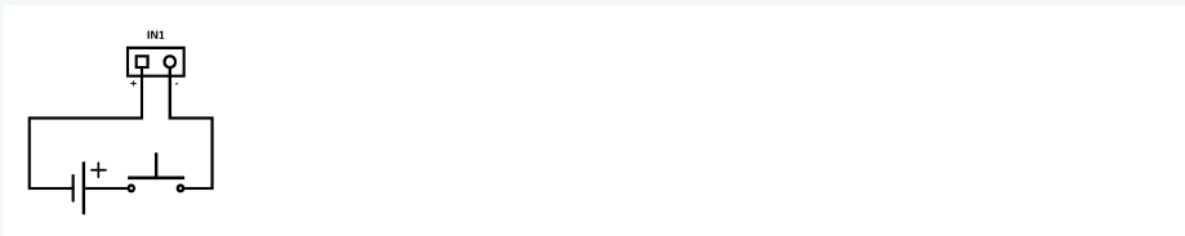

Electric Lock Connection

Connect the electric lock or another electric appliance directly to the device Active input or use a relay to switch the power supply. In the latter case, use an external lock supply. In any case, you are recommended to use low-consumption locks and keep the limits mentioned above.

⚠ **Warning**

When you connect a device containing a coil, such as a relay or an electromagnetic lock, it is necessary to protect the intercom against voltage peak while switching off the induction load. For this way of protection we recommend a diode 1 A / 1000 V (e.g., 1N4007, 1N5407, 1N5408) connected antiparallel to the device.

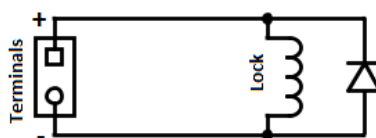

Main Unit

Power Supply Connection

2N IP Base can be powered either from an external 12 V / 2 A DC source or directly from the LAN equipped with PoE 802.3af supporting network elements.

External Power Supply

To make your device work reliably, use a safe 12 V ± 15 % voltage supply, **Part No. 91341481E** (SELV), dimensioned for current consumption according to the required performance, for the main unit supply (2 A, 24 W).

PoE Power Supply

2N IP Base is compatible with the PoE 802.3af (Class 0–12,95 W) technology and can be fed directly from the LAN via the compatible network elements. If your LAN does not support this technology, insert a PoE injector, Part No. 91378100, between **2N IP Base** and the nearest network element. This power supply provides **2N IP Base** with 12 W for feeding of the main unit.

Varování

- **2N IP Base** cannot be fed from an external power supply and PoE at the same time. A combined supply might result in a device damage.

LAN Connection

2N IP Base is connected to the Local Area Network (LAN) via the UTP/STP cable (Cat 5e or higher) terminated with an RJ-45 (LAN) connector. As the device is equipped with the Auto-MDIX function, both the straight and crossed cable can be used.

Caution

- We recommend the use of a LAN surge protection.
- We recommend the use of a shielded SSTP Ethernet cable.

Reset Button

Located among the main unit connectors, the Reset button helps you reset the factory default values, restart the device, find the device IP address and switch the static/dynamic mode.

IP Address Finding

Follow the instructions below to **identify the current IP address**:

- Press and hold the RESET button.
- Wait until the red and green LEDs go on simultaneously on the device and the acoustic signal  can be heard (approx. 15–35 s).
- Release the RESET button.
- The device automatically announces the current IP address.

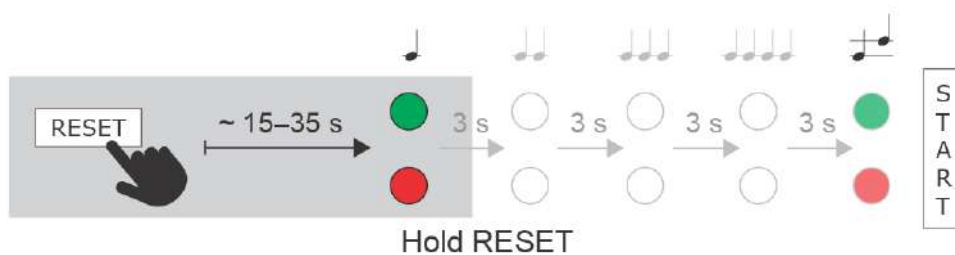



Note

- The delay after pressing RESET till the first light and sound signalling is set to 15–35 s depending on the 2N IP intercom/answering unit model used.
 - 18 s is the valid value for **2N IP Base**.

Static IP Address Setting

Follow the instructions below to switch on the **Static IP address** mode (DHCP OFF):

- Press and hold the RESET button.
- Wait until the red and green LEDs go on simultaneously on the device and the acoustic signal  can be heard (approx. 15–35 s).

- Wait until the red LED goes off and the acoustic signal  can be heard (approx. for another 3 s).
- Release the RESET button.

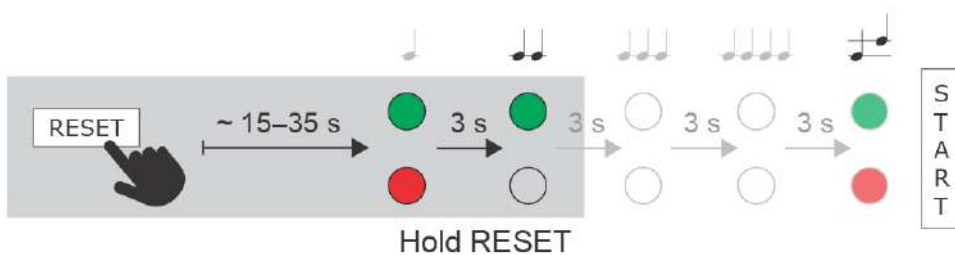

The following network parameters will be set after restart:

- IP address: 192.168.1.100
- Network mask: 255.255.255.0
- Default gateway: 192.168.1.1



Dynamic IP Address Setting



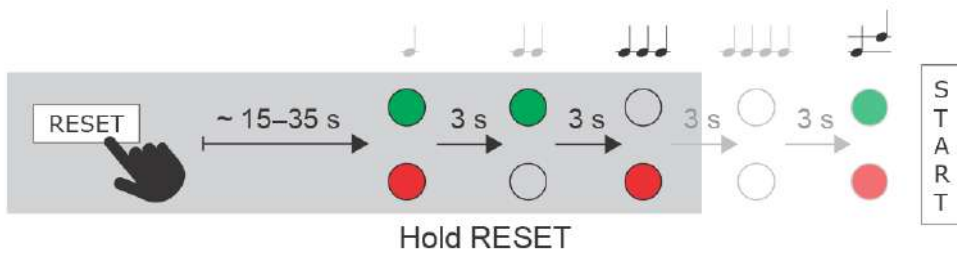

Follow the instructions below to switch on the **Dynamic IP address** mode (DCHP ON):

- Press and hold the RESET button.
- Wait until the red and green LEDs go on simultaneously on the device and the acoustic signal  can be heard (approx. 15–35 s).
- Wait until the red LED goes off and the acoustic signal  can be heard (approx. for another 3 s).
- Wait until the green LED goes off and the red LED goes on again and the acoustic signal  can be heard (approx. for another 3 s).
- Release the RESET button.



Factory Reset

Follow the instructions below to **reset the factory default values**:

- Press and hold the RESET button.
- Wait until the red and green LEDs go on simultaneously and the acoustic signal  can be heard (approx. 15–35 s).
- Wait until the red LED goes off and the acoustic signal  can be heard (approx. for another 3 s).
- Wait until the green LED goes off and the red LED goes on again and the acoustic signal  can be heard (approx. for another 3 s).
- Wait until the red LED goes off and the acoustic signal  can be heard (approx. for another 3 s).
- Release the RESET button.

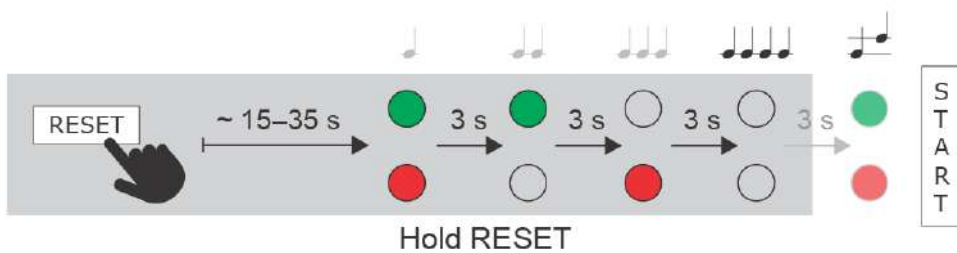

 **Caution**

- In case of resetting the factory default settings on a device with a version of firmware 2.18 or higher it is necessary to reprogram the **2N Security Relay** using the instructions from section [2.4](#).

Device Restart

Press the RESET button shortly (< 1 s) to restart the system without changing configuration.

 **Note**

- The time interval between the short press of RESET and reconnection after restart is 26 s for **2N IP Base**.

2.3.1 Overvoltage Protection

Recommendations for Additional Overvoltage Protection Installation

If running:

- a) outside a building,
- b) on/in an outer wall or roof,

the 2N device wiring may be exposed to atmospheric effects resulting in overvoltage that may subsequently damage any devices installed outside the building, on its outer wall or roof. Overvoltage may damage devices connected to these wires and installed inside the building as well. Therefore, we recommend that additional surge protectors be installed on all the wires leading outside buildings, on outer walls or roofs, namely:

- a) as close as possible to the device installed outside the building or on its outer wall/roof,
- b) as close as possible to the point where the wires leave the building.

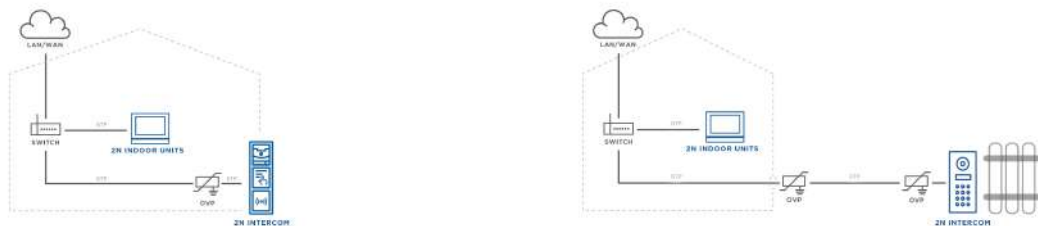

OVP = overvoltage protection

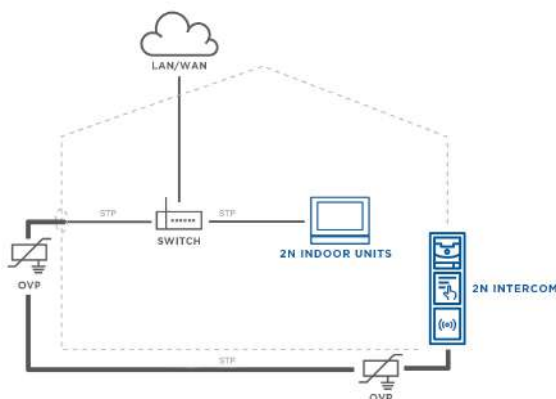

2.4 Extending Module Connection

2N® IP Base allows to connect following extending modules:

- RFID card reader 125 kHz
- RFID card reader 13.56 MHz, NFC/HCE
- Security Relay

Module Bus Interconnection

⚠ Caution

- In case the firmware versions of the module to be connected and the main unit are incompatible, the module will not be detected. Therefore, it is necessary to update the device firmware after the modules are connected. Use the device web interface in the System > Maintenance > System configuration section for firmware upgrade (see [Configuration manual for 2N IP intercoms](#)).

All modules **2N® IP Base**, are connected via connector X12, the position of this connector is shown in Fig. Before connecting RFID card reader it is suitable to disconnect **2N® IP Base** from the power supply. Only one module can be connected at a time.

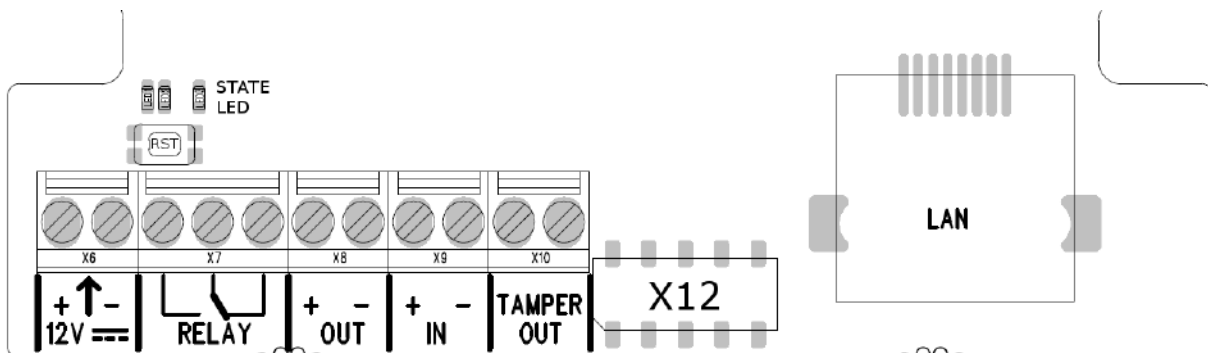

How to install modules:

- 1) On the picture there is a highlighted connector X12. This connector is designed to connect the module to the main unit.



2) Insert the module of card reader into the shown connector.



3) As the last, it is necessary to fix the module using tabs built into the structure of **2N® IP Base**. This tab is highlighted in the following picture by the red rectangle.



Module Power Supply

All modules **2N® IP Base** are powered via connector X12.

RFID Card Reader Module 125 kHz

The 125 kHz RFID Card Reader (**Part No. 9156030**) is one of the **2N® IP Base** intercom elements and is used for reading RFID card Ids in the 125 kHz band.

The following RFID cards can be read:

- EM4xxx

RFID Card Reader 13.56 MHz, NFC/HCE

The 13.56 MHz RFID Card Reader (**Part No. 9156031**) is one of the **2N® IP Base** intercom elements and is used for reading RFID card Ids in the 13.56 MHz band.

The following RFID cards can be read (only card serial number is read):

- ISO14443A (MIFARE DESFire)
- PicoPass (HID iClass)
- FeliCa
- ST SR(IX)
- 2N® Mobile Key

Security Relay

The **2N® Security Relay** (Part No. 9159010) is used for enhancing security between the intercom and the connected electric lock. The **2N® Security Relay** is designed for any **2N IP intercom** model with firmware versions 1.15 and higher. It significantly enhances security of the connected electric lock as it prevents lock opening by forced intercom tampering.



Function:

The **2N® Security Relay** is a device installed between an intercom (outside the secured area) and the electric lock (inside the secured area). The **2N® Security Relay** includes a relay that can only be activated if the valid opening code is received from the intercom.

Specifications:

Passive switch: NO and NC contacts, up to 30 V / 1 A AC/DC

Switched output:

- Where the security relay is fed from the intercom, 9 to 13 V DC is available on the output depending on the power supply (PoE: 9 V; adapter: source voltage of minus 1 V) / 400 mA DC.
- Where the security relay is fed from an external power supply, 12 V / 700 mA DC is available on the output.

Dimensions: (56 x 31 x 24) mm

Weight: 20 g

Installation:

Install the **2N® Security Relay** onto a two-wire cable between the intercom and the electric lock inside the area to be secured (typically behind the door). The device is powered and controlled via this two-wire cable and so can be added to an existing installation. Thanks to its compact dimensions, the device can be installed into a standard mounting box.

Connection:

Connect the **2N® Security Relay** to the intercom as follows:

- To the intercom active output (OUT1)

Connect the electric lock to the **2N® Security Relay** output as follows:

- To the switched output.
- To the passive output in series with the external power supply.

The device also supports a Departure button connected between the 'PB' and '- HeliosIP/IP Intercom' terminals. Press the Departure button to activate the output for 5 seconds.

Status signalling:

| Green LED | Red LED | Status |
|-----------|----------|---|
| blinking | off | Operational mode |
| on | off | Activated output |
| blinking | blinking | Programming mode – waiting for initialisation |
| on | blinking | Error – wrong code received |

Configuration:

- Connect the **2N® Security Relay** to the properly set intercom switch output; refer to the **Configuration manual for 2N IP intercoms**. Make sure that one LED at least on the **2N® Security Relay** is on or blinking.
- Press and hold the **2N® Security Relay** Reset button for 5 seconds to put the device in the programming mode (both the red and green LEDs are blinking).
- Activate the intercom switch using the keypad, telephone, etc. The first code sent from the intercom will be stored in the memory and considered valid. After code initialisation, the **2N® Security Relay** will pass into the operational mode (the green LED is blinking).

 **Caution**

- In case of resetting the factory default settings on a device with a version of firmware 2.18 or higher it is necessary to reprogram the **2N® Security Relay** using the instructions above.

✔ **Tip**

- FAQ: 2N® Security Relay – what it is and how to use it with 2N IP intercom?

Connection:

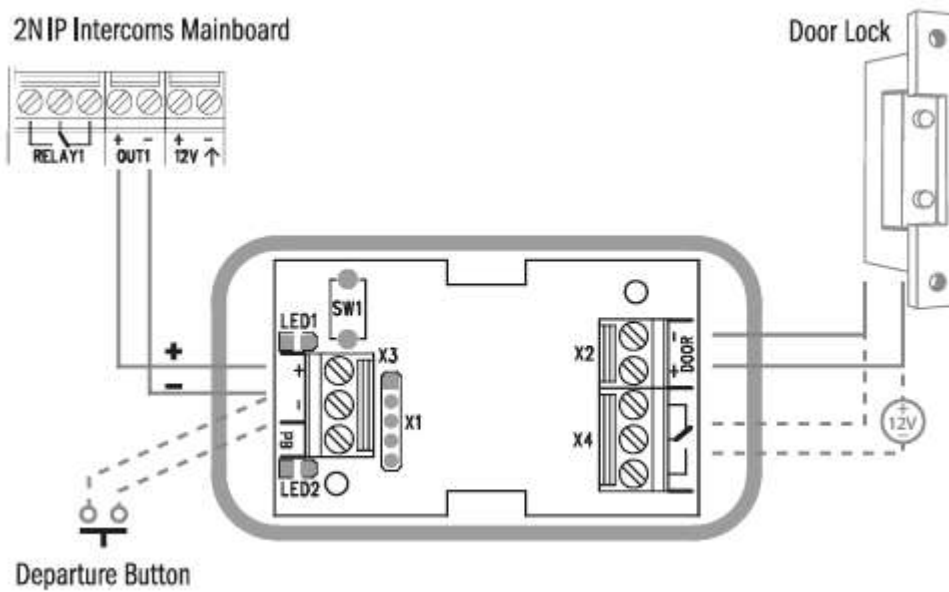

✔ **Tip**

Video Tutorial: Security Relay Installation and Configuration



Sorry, the widget is not supported in this export.
But you can reach it using the following URL:
<https://www.youtube.com/watch?v=ardukvQzw5A>

2.5 Completion

Installation Completion

Check the connection of all wires and the RJ-45 plug to the board connector.

⚠ Caution

- All unused connectors have to have tightened screws in order to avoid vibration caused by sound.

Nametag Placing

Every intercom package includes a piece of transparent foil, which can be laser printed. Download the printing template from www.2n.com. Do not use paper or other non-water-proof materials for your tags. Water may get inside the name tag – this has no influence on the device function.

⚠ Caution

- The area where nametags are placed is called a wet zone. After heavy rain, water can penetrate to the nametag. Water in this area does not affect the intercom functionality in any way and evaporates soon.
- Always use waterproof foil (enclosed or other) for the nametags. Never use paper or ink jet printing to avoid damage due to water leakage!

Nametag Inserting/Replacing:

1. Remove the frame.
2. Remove the button cover using the clips placed on the shorter sides of the cover.
3. Remove the used nametag and insert a new one.
4. Replace the button cover.
5. Replace the frame.

3. Function and Use

This section describes the basic and extending functions of the the **2N® IP Base** product.

Here is what you can find in this section:

- [3.1 Configuration](#)
- [3.2 Intercom Control as Viewed by External User](#)
- [3.3 Intercom Control as Viewed by Internal User](#)
- [3.4 Maintenance](#)
- [3.5 Downloads](#)

3.1 Configuration

Configuration takes place typically via a Web interface. Alternatively, it is possible to configure using the software **2N® Access Commander** or service **My2N**. Configuration via the web interface can be accessed as follows:

- Launch your internet browser (Internet Explorer, Firefox, etc.).
- Enter the IP address of your intercom (<http://192.168.1.100/>, e.g.).
- Log in using the username **Admin** and password **2n**.

You have to know your intercom IP address to log in to the integrated web server. Upon purchase, **2N® IP Base** is set to the dynamic IP address mode – it retrieves the IP address automatically if there is a properly configured DHCP server in the LAN. If no DHCP is available, operate **2N® IP Base** in the static IP address mode (in default state address <http://192.168.1.100>).

If you do not know the IP address of the device it is also possible to use the **2N® Network Scanner**, which can find the **2N IP intercom**, **2N® Access Unit** and **2N® IndoorTouch** in your network. You can find in section [3.6 Downloads](#).

If your device remains inaccessible (you have forgotten the IP address, the network configuration has changed, etc.), you can change the network configuration using the device buttons.

Refer to the **Configuration manual for 2N IP intercoms** for the **2N® IP Base** configuration details.

IP Address Retrieval

Take the following steps to retrieve the **2N® IP Base** IP address:

- Connect (or, if connected, disconnect and reconnect) **2N® IP Base** to the power supply.
- Wait for the second sound signal  .
- Press the quick dial button on the main unit 5 times.
- **2N® IP Base** will read its IP address.
- If the address is 0.0.0.0, it means that the intercom has not obtained the IP address from the DHCP server

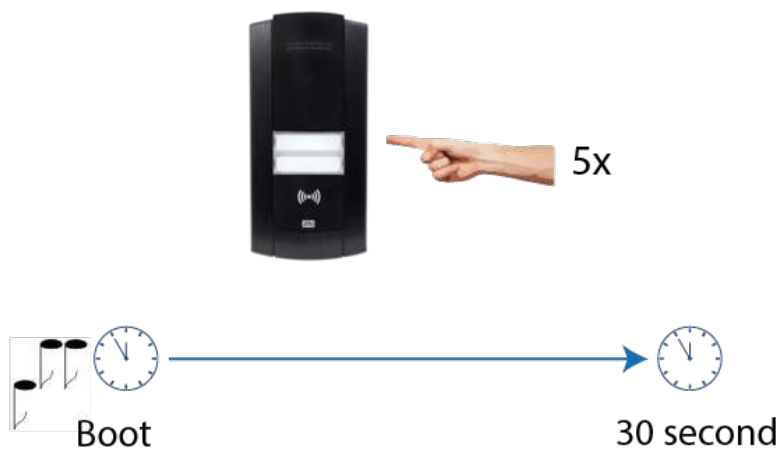



Note

- Be sure to press the button sequence within thirty seconds after the sound signal for security reasons. Up to 2 s intervals are allowed between the presses.

Dynamic/Static IP Address Switching

Take the following steps to switch the dynamic and static IP address mode in

2N® IP Base:

- Connect (or, if connected, disconnect and reconnect) **2N® IP Base** to the power supply.
- Wait for the first sound signal .
- Press the quick dial button on the main unit 15 times.
- Network parameter reset and DHCP switch are signaled by the  sound.
- For devices with FW versions 2.33 and lower, wait until the device is automatically restarted.
 - After restart, the static IP address mode is switched into the dynamic IP address and vice versa.
- Simultaneously, all the **System / Network** parameters are reset to default values. This is useful where it is impossible to connect to the device due to wrong VPN configuration, for example.



The following network parameters will be set after the static IP address mode is switched on and the device is restarted:

- IP address: 192.168.1.100
- Network mask: 255.255.255.0
- Default gateway: 192.168.1.

Note

- Be sure to press the button sequence within thirty seconds after the sound signal for security reasons. Up to 2 s intervals are allowed between the presses.

Firmware Upload

We also recommend you to update your intercom firmware upon the first login to the intercom. Use the device web interface in the System > Maintenance > System configuration section for firmware upgrade (see [Configuration manual for 2N IP intercoms](#)). Refer to [2N.com](#) for the latest firmware version. The device restarts automatically after the upgrade is completed successfully. The whole process takes almost one minute.

3.2 Intercom Control as Viewed by External User

This subsection describes how to control **2N® IP Base** when viewed by an external user.

Speed Dial Buttons

Press the speed dial buttons on the basic unit to make quick dialling for the first 1 or 2 (depending on the model type) in the telephone directory. Call setup is signalled by a long intermittent tone or otherwise as configured in the PBX connected.

Repeated pressing of one and the same speed dial button during call setup may initiate call termination, or call termination plus dialling the next telephone number of the called subscriber, or may be assigned no function.

3.3 Intercom Control as Viewed by Internal User

Call Answering

You can answer the incoming calls to the **2N® IP Base** intercom using your phone like any other calls. You can unlock the door, activate/deactivate a user/profile via your phone keypad during the call. The calls, however, are time-limited to avoid unintentional blocking of the **2N® IP Base** line. Set the maximum call duration in the **Call time limit** (refer to the Intercom Configuration / Services / Phone / Calls subsection of Configuration Manual). Press # on your

phone anytime to extend the call time. The automatic call termination is signalled with a short beep 10 s before the call end.



Calling to 2N® IP Base

2N® IP Base allows you to answer incoming calls. Set the required parameters in the Incoming calls group; refer to the Intercom Configuration / Services / Phone / Calls subsection of Configuration Manual.

Door Opening (Switch Activation) by Code

2N® IP Base is equipped with a door unlocking switch. Enter the valid code (refer to the Intercom Configuration / Hardware / Switches subsection of Configuration Manual) using your phone keypad to activate this switch.

Procedure:

- Enter the switch 1 or 2 activating code using your phone keypad and press  for confirmation. Confirmation is unnecessary if the **Lock code without confirmation** is enabled, refer to the Intercom Configuration / Hardware / Switches / Advanced subsection of Configuration Manual.
- A valid code is signalled by the  sound. An invalid code or interruption longer than as defined in **Timeout for Entering Numbers** is signalled by the  sound.

3.4 Maintenance

Cleaning

If used frequently, the device surface gets dirty. Use a piece of soft cloth moistened with clean water to clean the device.

We recommend that the principles below be followed while cleaning:

Use a piece of soft cloth moistened with clean water or non-aggressive detergents to clean the device. Use suitable cleaning agents for glass lens cleaning (cleaners for glasses, optical devices, screens, etc.). Do not use such abrasive pastes as scouring powder and peroxide, lye, acid and chlorine based detergents. Clean the device in dry weather in order to make waste water evaporate quickly. Cleaning wipes for IT equipment are suitable.

Warning

- Prevent water from getting inside the intercom.
- Do not use such abrasive pastes as scouring powder and peroxide, lye, acid and chlorine based detergents.

3.5 Downloads

Templates

[Nameplates](#)

[Drilling Template](#)

Software

[2N® USB driver](#)

[2N® IP Eye](#)

[2N® Network Scanner](#)

4. Technical Parameters

Signalling protocol

- **SIP (UDP, TCP, TLS)**

Buttons

- **Button design:** White-backlit transparent buttons with replaceable nametags
- **Button count:** 1 or 2

Audio

- **Microphone:** 1 integrated microphone
- **Amplifier:** 2 W (class D) amplifier
- **Speaker:** 2 W / 8 Ω
- **Sound pressure level (SPL max):** 78 dB (for 1 kHz, distance 1 m)
- **Volume control:** Adjustable with automatic adaptive mode
- **Full duplex:** Yes (AEC)
- **Speech transmission index (STI):** 0.80

Audio stream

- **Protocols:** RTP
- **Codecs:** G.711, G.729, G.722, L16/16 kHz

Camera

- **Sensor:** 1/3" colour CMOS
- **JPEG resolution:** Up to 1280 (H) x 960 (V)
- **Video resolution:** 640 (H) x 480 (V)
- **Frame rate:** Up to 30 snapshots/s
- **Sensor sensitivity:** 5.6 V/lux-sec (550 nm)
- **View angle:** 135 ° (H), 109 ° (V), 141 °(D)
- **Infrared light:** No
- **Sensor sensitivity without IR light:** 0,1 Lux \pm 20 %
- **Focal length:** 2.3 mm

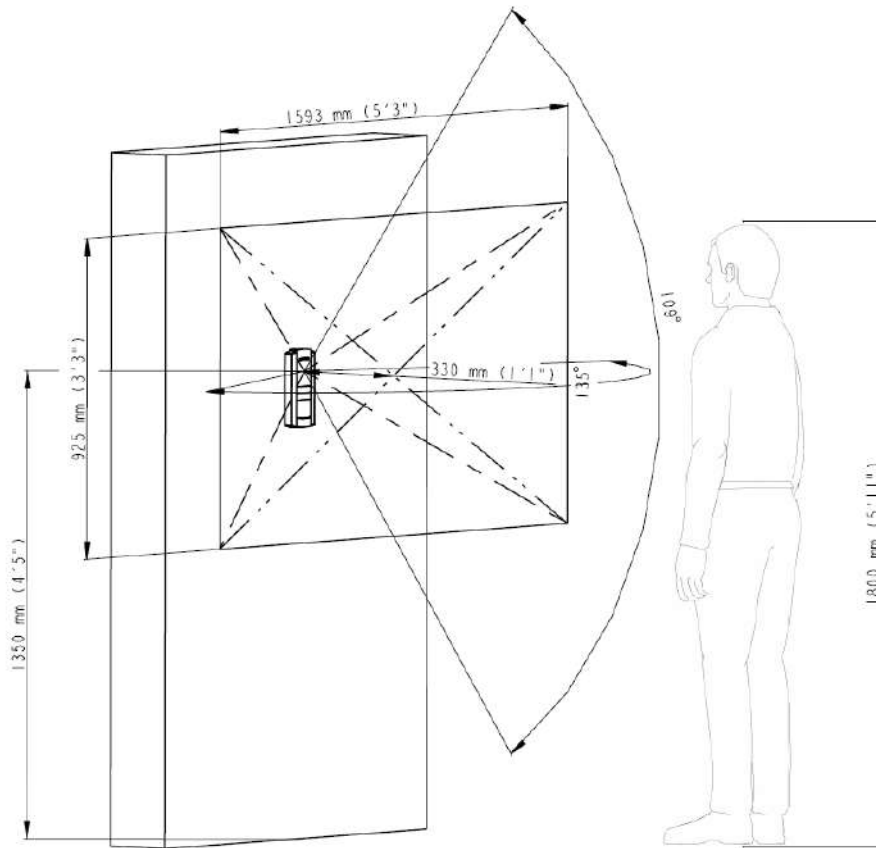

Video stream

- **Protocols:** RTP / RTSP / HTTP
- **Video call codecs:** H.264, H.263+, H.263
- **ONVIF/RTSP stream codecs:** H.264, MPEG4, MJPEG
- **IP camera function:** yes, ONVIF v2.4 profile S compatible

Bandwidth

- **Audio codecs**
 - PCMA, PCMU – 64 kbps (with 85.6 kbps headers)
 - G.729 – 16 kbps (with 29.6 kbps headers)
 - G.722 – 64 kbps (with 85.6 kbps headers)
 - L16 / 16 kHz – 256 kbps (with 277.6 kbps headers)

- **Video codecs**

Set the video codec data flows in the Services / Phone / Video menu for calls and in the Services / Streaming / RTSP menu for streaming. The set transmission rate is the value to which the codec should draw near in a long term average. The data flows can vary depending on the scene to be scanned.

Interface

- **Power supply:** 12 V \pm 15 % / 2 A DC or PoE
- **PoE:** PoE 802.3af (Class 0–12.95 W)
- **LAN:** 10/100BASE-TX with Auto-MDIX, RJ-45
- **Recommended cabling:** Cat-5e or higher
- **Supported protocols:** SIP2.0, RTP, HTTP, HTTPS, Syslog
- **Passive switch:** NO/NC contact, up to 30 V / 1 A AC/DC
- **Active switch output:** 8 up to 12 V DC depending on power supply (PoE: 10 V; adaptor: power supply voltage minus 2 V), max 600 mA

RFID card reader

- **Optionally 125 kHz or 13.56 MHz**
- **Supported cards, 125 kHz, Part No. 9156030:**
 - EM4100, EM4102
- **Supported cards, 13.56 MHz, Part No. 9156031** (only card serial number is read)
 - ISO/IEC 14443A
 - , MIFARE Classic 1k & 4k, MIFARE DESFire EV1, Mini, Plus S&X, Ultralight, Ultralight C
 - ISO/IEC 14443B
 - CEPAS, HID iCLASS
- JIS X 6319
- Felica
- ISO/IEC 18092
 - SmartPhone with NFC/HCE support, since Android version 4.3

Mechanical properties

- **Cover:** Robust aluminium casting with surface finish
- **Working temperature:** -40 °C – 55 °C
- **Working relative humidity:** 10 % – 95 % (non-condensing)
- **Storing temperature:** -40 °C – 70 °C
- **Dimensions:** 229 (W) x 109 (H) x 31 (H)
- **Weight:** Max net weight: 1 kg
- **Covering level:**
 - IK 7
 - IP 65

4.1 General drawings

Surface mounting

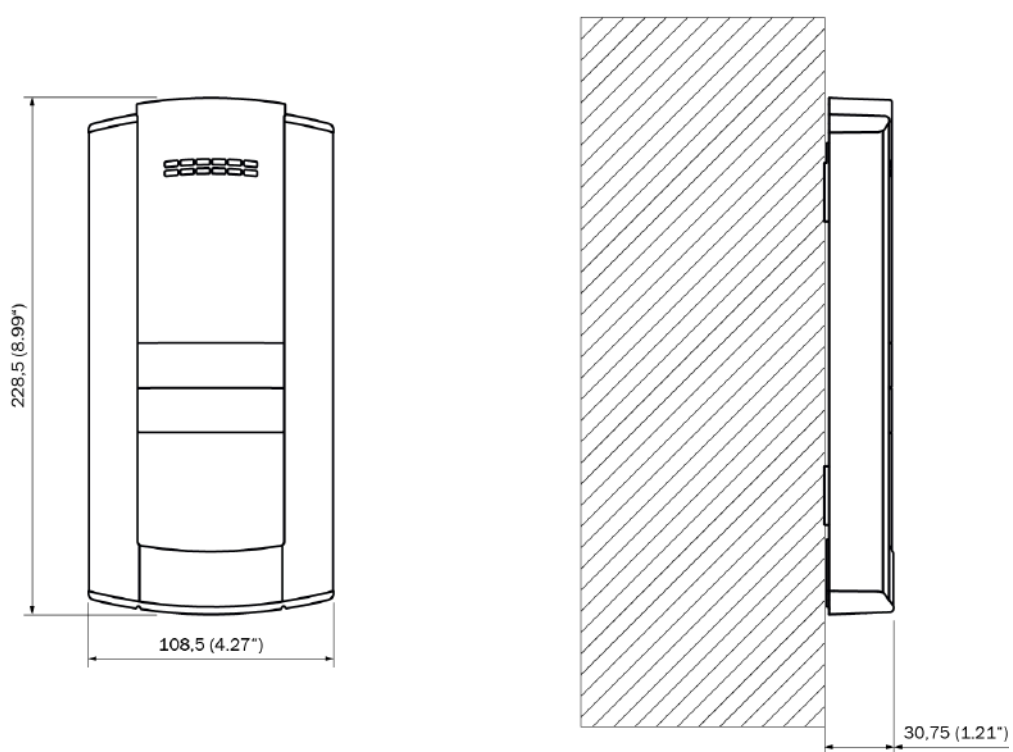

5. Supplementary Information

Here is what you can find in this section:

- [5.1 Troubleshooting](#)
- [5.2 Directives, Laws and Regulations](#)
- [5.3 Other Countries' Legislation](#)
- [5.4 General Instructions and Cautions](#)

5.1 Troubleshooting



For the most frequently asked questions refer to faq.2n.cz.

5.2 Directives, Laws and Regulations

2N® IP Base conforms to the following directives and regulations:

- 2014/53/EU for radio equipment
- 2011/65/EU on the restriction of the use of certain hazardous substances in electrical and electronic equipment
- 2012/19/EU on waste electrical and electronic equipment

⚠ Caution**Warning**

In order to ensure the full functionality and guaranteed performance, we strongly recommend that the topicality of the product / device version in use be verified as early as in the installation process. The customer hereby acknowledges that the product / device can achieve the guaranteed performance and full functionality pursuant to the manufacturer's instructions only if the latest product / device version is used after having been tested for full interoperability and not having been determined by the manufacturer as incompatible with certain versions of other products, and only in conformity with the manufacturer's instructions, guidelines or recommendations and in conjunction with suitable products and devices of other suppliers. The latest versions are available at https://www.2n.com/cs_CZ/ or can be updated via the configuration interface if the devices are adequately technically equipped. Should the customer use a product / device version other than the latest one or a version determined by the manufacturer as incompatible with certain versions of other products, or should the customer use the product / device in contradiction to the manufacturer's instructions, guidelines or recommendations or in conjunction with unsuitable products / devices of other suppliers, the customer is aware of and agrees with all functionality limitations of such a product / device if any as well as with all consequences incurred as a result thereof. Using a product / device version other than the latest one or a version determined by the manufacturer as incompatible with certain versions of other products, or using the product / device in contradiction to the manufacturer's instructions, guidelines or recommendations or in conjunction with unsuitable products / devices of other suppliers, the customer agrees that the 2N TELEKOMUNIKACE a.s. company shall not be held liable for any functionality limitation of such a product or any damage, loss or injury related to this potential functionality limitation.

5.3 Other Countries' Legislation

| | |
|------------------------|---|
| <p>Thailand</p> | <div style="border: 1px solid black; padding: 10px;"> <p style="text-align: center;">เครื่องโทรคมนาคมและอุปกรณ์นี้ ความสำเร็จคล่องตามมาตรฐานหรือขอ กำหนดทางเทคนิคของ กสทช.</p> <hr/> <div style="text-align: center;">  <p>nans.</p> </div> <p>เครื่องวิทยุคมนาคมนี้ ได้รับยกเว้น ไม่ต้องได้ รับใบอนุญาตให้มี ใช้ซึ่งเครื่องวิทยุคมนาคม หรือตั้งสถานีวิทยุคมนาคมตามประกาศ กสทช. เรื่อง เครื่องวิทยุคมนาคม และสถานีวิทยุ คมนาคมที่ได้รับยกเว้นไม่ต้องได้รับใบอนุญาต วิทยุคมนาคมตามพระราชบัญญัติวิทยุคมนาคม พ.ศ. 2498</p> <div style="display: flex; justify-content: space-between; align-items: center;">  <div style="text-align: right;"> <p>nans. โทรคมนาคม</p> <p>กำกับดูแลเพื่อประชาชน</p> <p>Call Center 1200 (InswS)</p> </div> </div> </div> |
|------------------------|---|

5.4 General Instructions and Cautions

Please read this User Manual carefully before using the product. Follow all instructions and recommendations included herein.

Any use of the product that is in contradiction with the instructions provided herein may result in malfunction, damage or destruction of the product.

The manufacturer shall not be liable and responsible for any damage incurred as a result of a use of the product other than that included herein, namely undue application and disobedience of the recommendations and warnings in contradiction herewith.

Any use or connection of the product other than those included herein shall be considered undue and the manufacturer shall not be liable for any consequences arisen as a result of such misconduct.

Moreover, the manufacturer shall not be liable for any damage or destruction of the product incurred as a result of misplacement, incompetent installation and/or undue operation and use of the product in contradiction herewith.

The manufacturer assumes no responsibility for any malfunction, damage or destruction of the product caused by incompetent replacement of parts or due to the use of reproduction parts or components.

The manufacturer shall not be liable and responsible for any loss or damage incurred as a result of a natural disaster or any other unfavourable natural condition.

The manufacturer shall not be held liable for any damage of the product arising during the shipping thereof.

The manufacturer shall not make any warrant with regard to data loss or damage.

The manufacturer shall not be liable and responsible for any direct or indirect damage incurred as a result of a use of the product in contradiction herewith or a failure of the product due to a use in contradiction herewith.

All applicable legal regulations concerning the product installation and use as well as provisions of technical standards on electric installations have to be obeyed. The manufacturer shall not be liable and responsible for damage or destruction of the product or damage incurred by the consumer in case the product is used and handled contrary to the said regulations and provisions.

The consumer shall, at its own expense, obtain software protection of the product. The manufacturer shall not be held liable and responsible for any damage incurred as a result of the use of deficient or substandard security software.

The consumer shall, without delay, change the access password for the product after installation. The manufacturer shall not be held liable or responsible for any damage incurred by the consumer in connection with the use of the original password.

The manufacturer also assumes no responsibility for additional costs incurred by the consumer as a result of making calls using a line with an increased tariff.

Electric Waste and Used Battery Pack Handling



Do not place used electric devices and battery packs into municipal waste containers. An undue disposal thereof might impair the environment!

Deliver your expired electric appliances and battery packs removed from them to dedicated dumpsites or containers or give them back to the dealer or manufacturer for environmental-friendly disposal. The dealer or manufacturer shall take the product back free of charge and without requiring another purchase. Make sure that the devices to be disposed of are complete.

Do not throw battery packs into fire. Battery packs may not be taken into parts or short-circuited either.

