

# 2N<sup>®</sup> Indoor Compact User Manual



## Content:

- 1. Product Description
  - 1.1 Product Description
  - 1.2 Differences between Models and Associated Products
  - 1.3 Terms and Symbols Used
  - 1.4 Safety Precautions
- 2. Description and Installation
  - 2.1 Before You Start
  - 2.2 Brief Installation Guide
  - 2.3 Installation Conditions
  - 2.4 2N® Indoor Compact LAN Location via 2N® Network Scanner
  - 2.5 IP Address Lookup
- 3. Configuration
  - 3.1 Factory Reset
  - 3.2 Software Configuration
    - 3.2.1 Status
      - 3.2.1.1 Device
      - 3.2.1.2 Services
      - 3.2.1.3 Events
    - 3.2.2 Directory
    - 3.2.3 Services
      - 3.2.3.1 Phone
      - 3.2.3.2 Unlocking
      - 2.3.2.3 HTTP Command
      - 3.2.3.4 User Sounds
      - 3.2.3.5 Web Server
    - 3.2.4 Hardware
      - 3.2.4.1 Audio
      - 3.2.4.2 Display
      - 3.2.4.3 Digital Inputs
    - 3.2.5 System
      - 3.2.5.1 Network
      - 3.2.5.2 Date and Time
      - 3.2.5.3 Certificates
      - 3.2.5.4 Auto Provisioning
      - 3.2.5.5 Syslog
      - 3.2.5.6 Maintenance
- 4. Device Control via Display
  - 4.1 Directory
  - 4.2 Call Log
  - 4.3 Do Not Disturb Mode
  - 4.4 Settings
- 5. Operational Statuses
- 6. Maintenance – Cleaning

- 7. Technical Parameters
- 8. Supplementary Information
  - 8.1 Troubleshooting
  - 8.2 Directives, Laws and Regulations - General Instructions and Cautions

# 1. Product Description

In this section, we introduce the **2N® Indoor Compact** product, outline its application options and highlight the advantages following from its use. The section also includes safety precautions.

- [1.1 Product Description](#)
- [1.2 Differences between Models and Associated Products](#)
- [1.3 Terms and Symbols Used](#)
- [1.4 Safety Precautions](#)

## 1.1 Product Description

**2N® Indoor Compact** is a stylish, compact-design indoor IP/SIP unit providing audio and video communication with the **2N IP intercoms**. The device includes a 4 mm enhanced glass touchscreen panel, Speakerphone, high-quality microphone with excellent audibility and intelligibility properties, Ethernet LAN interface and induction loop and doorbell external supply connectors. **2N® Indoor Compact** is a top-quality, cost efficient and easy to install and configure answering unit. One installation can combine variable answering units manufactured by 2N Telekomunikace a.s.

**2N® Indoor Compact** is equipped with a specific user interface for an increased user comfort and safety.

### Basic Features **2N® Indoor Compact**:

- 4.3" color LCD video display
- full duplex handsfree HD audio communication
- LAN interface with PoE supply option
- easy flush mounting
- combination with **2N® Indoor Touch** and **2N® Indoor Talk** answering units
- remote administration and configuration via **2N® Remote Configuration**
- call setup option via **2N® Mobile Video** on a smartphone
- DND mode and parental lock
- remote door lock control
- time display at relax
- integrated user web interface
- external doorbell button input
- external power supply input
- induction loop output



## 1.2 Differences between Models and Associated Products

### 2N® Indoor Compact

**2N Part No. 91378501**

**Axis Part No. 01935-001**

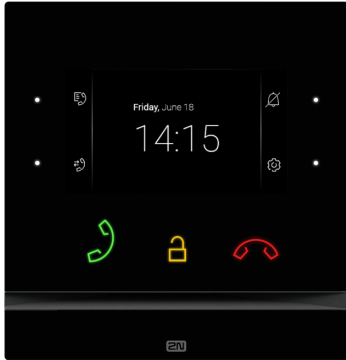

- **2N® Indoor Compact** – black
- Indoor answering audio/video unit with touch buttons designed for all **2N IP intercoms**

**2N Part No. 91378501WH**

**Axis Part No. 01936-001**



- **2N® Indoor Compact** – white
- Indoor answering audio/video unit with touch buttons designed for all **2N IP intercoms**

### Other Indoor Units and Accessories

**Part Numbers:**

**2N Part No. 91378375**

**Axis Part No. 01668-001**

**2N Part No. 91378376**

**Axis Part No. 01670-001**



- **2N® Indoor Touch 2.0** – black
- WiFi version (third and fourth Part Nos.)
- **2N® Indoor Touch 2.0**, an elegant indoor touch panel, is designed for all of the **2N IP intercoms**. The display panel shows you the person standing at your door and helps you make conversation with the visitor, open the door lock or switch on the entrance hall lights.

**2N Part No. 91378382**  
**Axis Part No. 01425-001**



- **2N® Indoor Touch** – desk stand black

**Part Numbers:**

**2N Part No. 91378375WH**  
**Axis Part No. 01669-001**  
**2N Part No. 91378376WH**  
**Axis Part No. 01671-001**



- **2N® Indoor Touch 2.0** – white
- WiFi version (third and fourth Part Nos.)
- **2N® Indoor Touch 2.0**, an elegant indoor touch panel, is designed for all of the **2N IP intercoms**. The display panel shows you the person standing at your door and helps you make conversation with the visitor, open the door lock or switch on the entrance hall lights.

**2N Part No. 91378382W**  
**Axis Part No. 01426-001**



- **2N® Indoor Touch** – desk stand white

**Part Numbers:**

**2N Part No. 91378381E**

**2N Part No. 91378381GB**

**2N Part No. 91378381US**



- The exclusive type of power adapter **SYS1561-0912** to be used with all 2N® Indoor Touch 2.0 devices.
- Stabilised 12 V / 0,75 A source to be used where PoE supply is unavailable.
- The part numbers differ in their electric socket markings (E/GB/US).

**2N Part No. 91378401**

**Axis Part No. 01698-001**



- **2N® Indoor Talk** – black
- Indoor answering audio unit with touchscreen designed for all **2N IP intercoms**



**2N Part No. 91378401WH**

**Axis Part No. 01699-001**



- **2N® Indoor Talk** – white
- Indoor answering audio unit with touchscreen designed for all **2N IP intercoms**

VoIP Phones

|   |  |
|---|--|
| <p><b>Part No. 91378358</b><br/><b>Axis Part No. 01421-001</b></p>   | <ul style="list-style-type: none"> <li>• Grandstream GXV3240 VoIP video telephone</li> <li>• GXV3240 is the successor to the popular GXV3140 model, which provides comfortable video calls in the IP network. Touchscreen and keypad control.</li> </ul> |
| <p><b>Part.No. 91378357</b><br/><b>Axis Part No. 01422-001</b></p>  | <ul style="list-style-type: none"> <li>• Grandstream GXV3275 VoIP video telephone</li> <li>• GXV3275 is the successor to the popular GXV3175 model, which provides comfortable video calls in the IP network. Touchscreen control.</li> </ul>            |

Mounting Accessories

|  |   |
|--|---|
| <p><b>2N Part No.</b><br/><b>91378800</b></p> <p><b>Axis Part No.</b><br/><b>01700-001</b></p>  | <ul style="list-style-type: none"> <li>• Flush mounting box is necessary for brick/plasterboard walls.</li> <li>• Not included in the <b>2N® Indoor Compact</b> package.</li> </ul> |
|--|---|

**2N Part No.  
91378803**

**Axis Part No.  
02320-001**



- Wall mounting box for 2N answering units
- Not included in the **2N® Indoor Compact** package.

**2N Part No.  
91378802**

**Axis Part No.  
02039-001**



- 2N Indoor answering unit desk stand.
- Not included in the **2N® Indoor Compact** package.

## 1.3 Terms and Symbols Used

The following symbols and pictograms are used in the manual:

### **Safety**

- **Always abide** by this information to prevent persons from injury.

### **Warning**

- **Always abide** by this information to prevent damage to the device.

### **Caution**

- **Important information** for system functionality.

### **Tip**

- **Useful information** for quick and efficient functionality.

### **Note**

- Routines or advice for efficient use of the device.

## 1.4 Safety Precautions

The manufacturer reserves the right to modify the product in order to improve its qualities. The manufacturer continuously responds to the clients' requirements by improving the software.

Refer to the [www.2n.com](http://www.2n.com) company websites for the latest **2N® Indoor Compact** firmware and User Manual.

- Where necessary, the device can be installed at a safe distance from the prohibited area and an Ethernet cable can only be carried to the required site.
- Install **2N® Indoor Compact** out of reach of sensitive devices and human bodies as it emits electromagnetic interference.
- Refer to [6. Technical Parameters](#) for the range of operating temperatures.
- The device may not be operated at places exposed to direct sunlight or near heat sources.
- **2N® Indoor Compact** is designed for indoor use. It may not be exposed to rain, flowing water, condensing moisture, fog, and so on.
- It may not be exposed to aggressive gases, acid and solvent vapors, etc.

It is designed for LAN connection.

### **Caution**

- This product and its installation and configuration techniques are not intended for persons with diminished physical, sensory or mental capacities or persons with limited experience and knowledge unless expertly supervised or duly advised as to the use of this product by a person responsible for their safety.



## 2. Description and Installation

This section describes how to install and connect **2N® Indoor Compact** properly.

Here is what you can find in this section:

- [2.1 Before You Start](#)
- [2.2 Brief Installation Guide](#)
- [2.3 Installation Conditions](#)
- [2.4 2N® Indoor Compact LAN Location via 2N® Network Scanner](#)
- [2.5 IP Address Lookup](#)

### 2.1 Before You Start

#### Package Completeness Check

Please check the product delivery before starting installation: Contents:

|   |  |
|---|--|
| 1 | <b>2N® Indoor Compact</b>                    |
| 2 | External power and doorbell button terminals |
| 1 | Certificate of ownership                     |
| 1 | 2.5 mm hexagon key wrench                    |
| 1 | Quick Start manual                           |
| 1 | Display cleaning cloth                       |

Front Layout

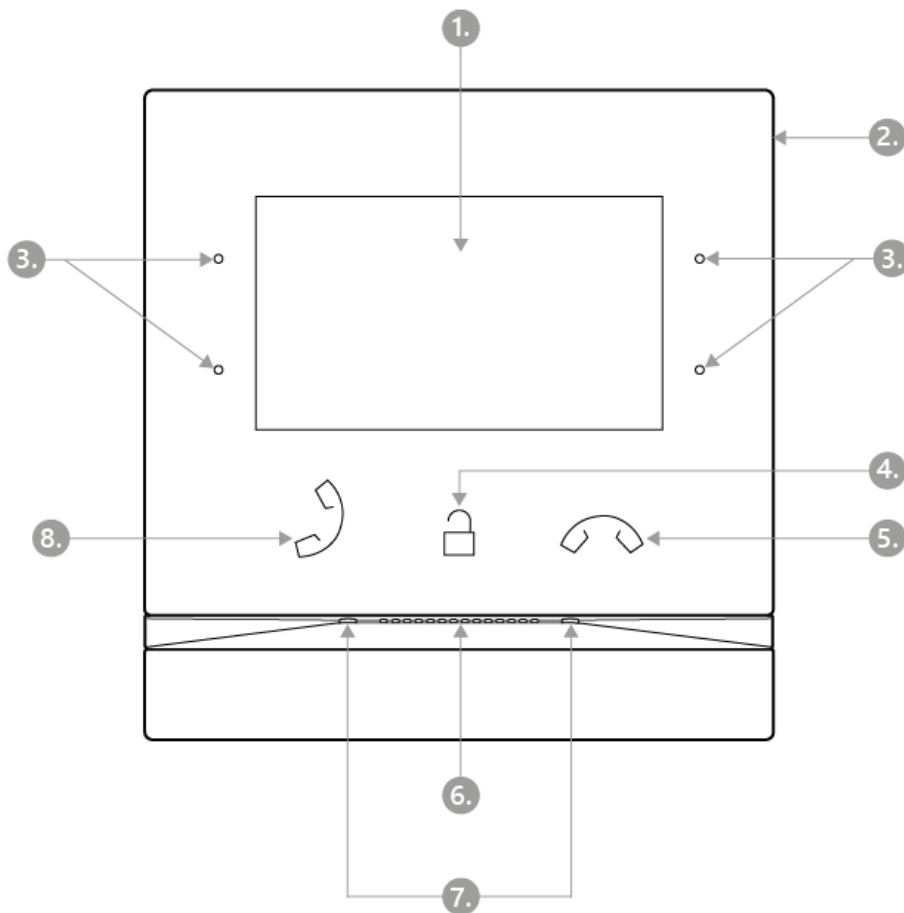

1. Display
2. Microphone
3. MENU buttons
4. Lock button
5. Call end button
6. Speaker
7. Anchoring holes
8. Call answering button

## Backside Connectors

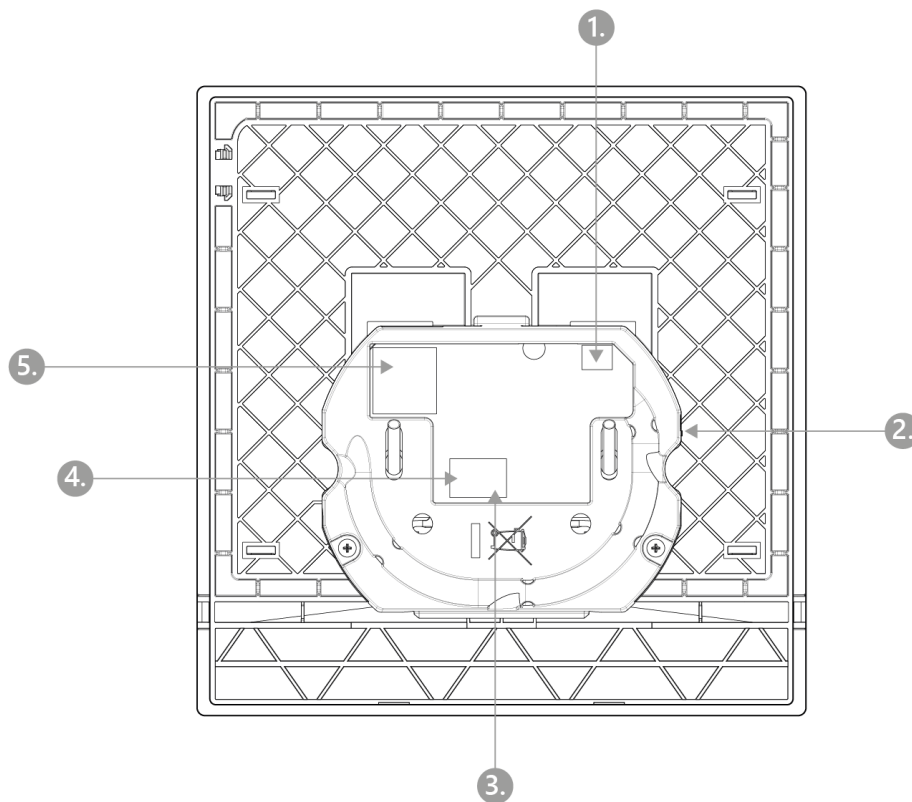

1. External induction loop output
2. Reset button
3. Doorbell button input
4. 12 V / 1 A DC power supply input
5. Ethernet

**2N® Indoor Compact** is designed for flush mounting (brick, plasterboard, wood). Use the flush mounting box (Part No. 91378800), which is not included in the package. Alternatively, the product can be mounted into a desk stand (Part No. 91378802), which is not included in the package.

**⚠ Caution**

- Before starting the mechanical installation on a selected place, make sure carefully that the preparations connected with it (drilling, wall cutting) cannot damage the electrical, gas, water and other existing wires and pipes.

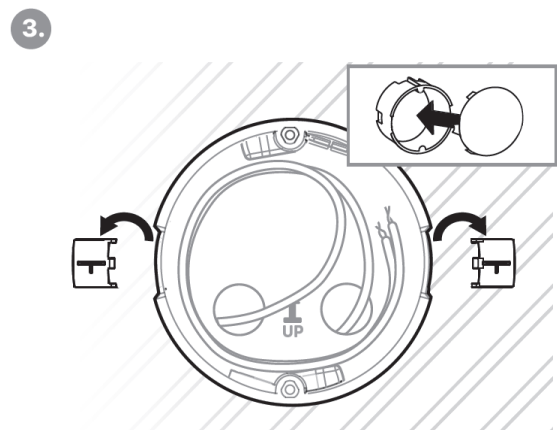
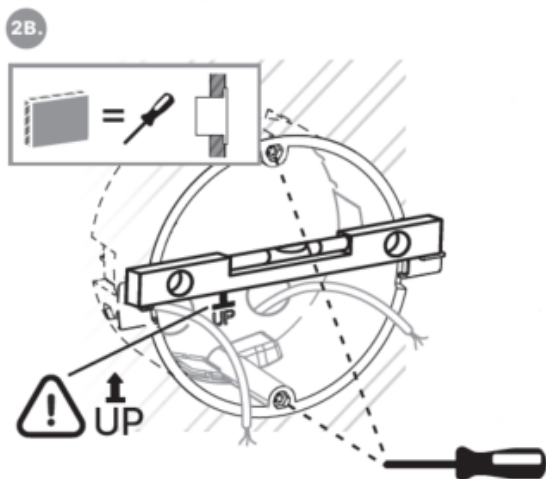
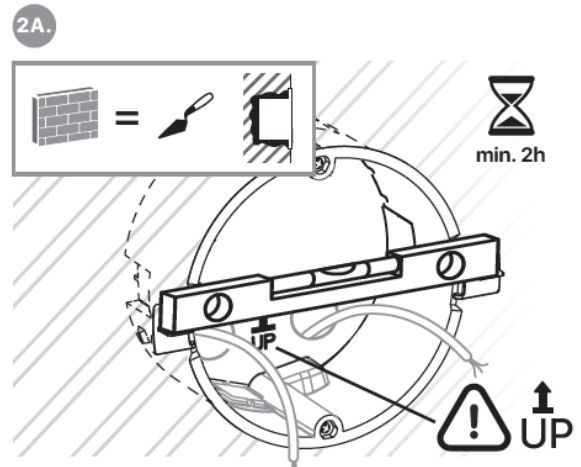
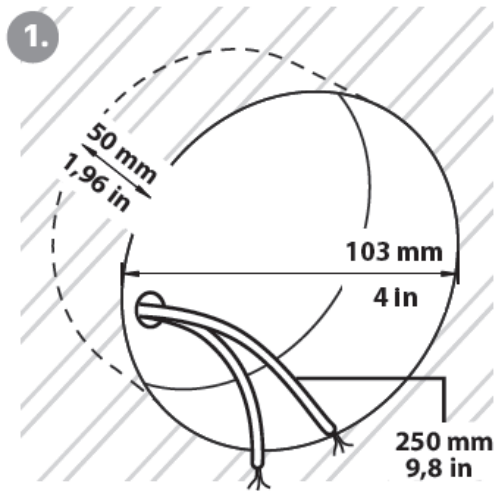

Cut a circular hole in the wall of the diameter of 103 mm and depth of 50 mm before installation. It is assumed that all necessary cables of the maximum length of 25 cm will lead to the hole. Put the flush mounting box in the hole to make sure that the hole is deep enough. If the hole complies with the box size, wall in the box and level the box using a water level on the holding clips. When the mortar hardens, break off the clips and cap the box with the cover provided. Use anchoring elements to fix the device into plasterboard.

✓ **Downloads**

[Drilling template.pdf](#)

Use a 2.5 mm hexagon key wrench (included in the **2N® Indoor Compact** delivery) for fitting **2N® Indoor Compact** into the flush mounting box.

ⓘ **Note**

- While flush mounting **2N® Indoor Compact** respect the local standards concerning installation of electronic devices on flammable materials.

## 2.2 Brief Installation Guide

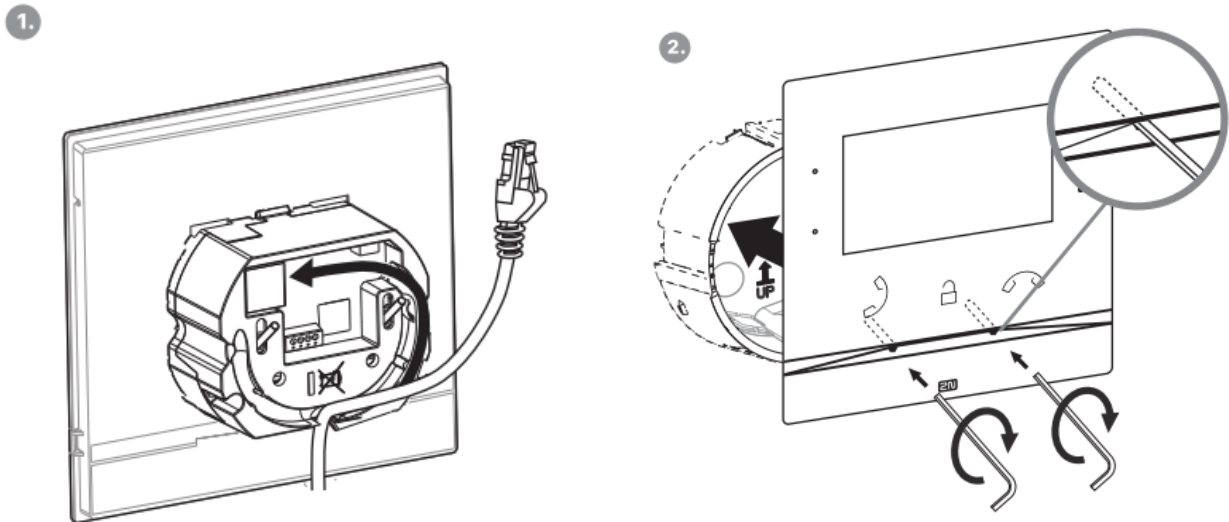

Remove the cover from the walled-in **2N® Indoor Compact** flush mounting box. Remove the pre-prepared cabling, UTP cable, doorbell twin cable and power supply cable. Shorten the cables to 150 mm or less as required. Connect the doorbell twin cable or power supply cable to the connector provided. Crimp the RJ-45 connector onto the UTP cable. Take **2N® Indoor Compact** and lean its bottom edge against the wall below the flush mounting box. First plug the green power/doorbell connector. Connect the LAN connector. Put the cables carefully in the pre-drilled **2N® Indoor Compact** back slot to prevent them from blocking any horizontal levelling movement during the final installation stage. Insert **2N® Indoor Compact** in the flush mounting box making sure that it clicks onto the levelling pins, which allow for a 5–6° inclination on either side for accurate horizontal levelling. Apply the box screw nuts with the hexagon key wrench provided. Level **2N® Indoor Compact** with a water level and tighten the screws gently. Now **2N® Indoor Compact** is ready for basic operation.

**2N® Indoor Compact** consumption with variable power supplies:

| Supply type       | Consumption |
|-------------------|-------------|
| PoE, IEEE 802.3af | 12 W        |
| 12 V / 1 A        | 12 W        |

 **Warning**

- Do not connect any external power supply if PoE is used and vice versa.
- If you use a power adapter other than the recommended one, do not exceed the 12 V rated supply voltage. Also check the supply voltage polarity. Higher voltage values or misconnections may result in an irreplaceable device damage.

## 2.3 Installation Conditions

Make sure that the following **2N® Indoor Compact** installation conditions are met:

- There must be enough space for the device installation.
- The device is designed for vertical wall mounting (perpendicular to the floor) in the height of up to 120 cm above the floor. If necessary, operate the device in a position other than as aforementioned for a short time only, for quick testing purposes in a servicing center, for example.
- Exceeding the allowed operating temperature may not affect the device immediately but leads to premature ageing and lower reliability. For the acceptable range of operating temperatures and relative humidity values refer to [Technical Parameters](#).
- The device is not designed for environments with increased vibrations such as means of transport, machine rooms and so on.
- The device is not intended for dusty environments and places with unstable humidity and abrupt temperature changes.
- The device may not be exposed to aggressive gas, acid vapors, solvents, etc.
- The device is not intended for direct connection into the Internet/WAN.
- The device must be connected to the Internet/WAN via a separating active network element (switch/router).
- The device is designed for indoor use. It may not be exposed to rain, flowing water, condensing moisture, fog, etc.
- The device cannot be operated on places exposed to direct sunshine and near heat sources.
- Keep some free space above and below the device to allow air to flow and conduct heat away.
- No strong electromagnetic radiance is allowed on the installation site.
- Make sure that the VoIP connection is configured properly according to the SIP and other VoIP recommendations.
- It is recommended that the power adapter be connected to the mains via a UPS and reliable overvoltage protection.

### Power Supply Connection

You can feed **2N® Indoor Compact** as follows:

1. Use a 12 V / 1 A DC power adapter connected to the backside terminal board.
2. Use an Ethernet cable connected to a PoE supply or PoE supporting Ethernet switch/router.

### PoE Supply Connection

Use a standard straight RJ-45 terminated cable to connect **2N® Indoor Compact** to the Ethernet. The device supports the 10BaseT and 100BaseT protocols. The Ethernet connection state is



indicated by a hung-up receiver symbol . If the symbol flashes, the device is disconnected from the network.

**⚠ Caution**

- Factory reset results in a change of the Ethernet interface configuration!
- A defective Ethernet cable may lead to a high packet loss in the Ethernet and subsequent instability and poor call quality!

**⚠ Warning**

- Do not connect any external power supply if PoE is used and vice versa.
- Connection of a defective or improper power supply may lead to a temporary or permanent device failure.

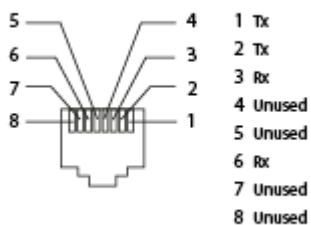
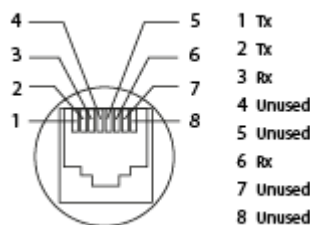
| Ethernet cable connector   | Ethernet socket   |
|--|---|
|  <p>5 4 1 Tx<br/>6 3 2 Tx<br/>7 2 3 Rx<br/>8 1 4 Unused<br/>5 Unused<br/>6 Rx<br/>7 Unused<br/>8 Unused</p> |  <p>4 5 1 Tx<br/>3 6 2 Tx<br/>2 7 3 Rx<br/>1 4 8 Unused<br/>5 Unused<br/>6 Rx<br/>7 Unused<br/>8 Unused</p> |

### Firmware Upload

We recommend you to upgrade the **2N® Indoor Compact** firmware during installation. Refer to [www.2n.com](http://www.2n.com) for the latest FW version. Refer to [3.2.5 System](#) for the firmware upgrade procedure.

## 2.4 2N® Indoor Compact LAN Location via 2N® Network Scanner

**2N® Indoor Compact** is configured via the administration web server. Connect the device to the LAN IP and make sure it is properly powered.

### 2N® Network Scanner Description

The application helps find the IP addresses of all the **2N® Indoor Compact** devices in the LAN. Download the app from the 2N web sites ([www.2n.com](http://www.2n.com)). Make sure that Microsoft .NET Framework 2.0 is installed for successful app installation.

1. Run the **2N® Network Scanner**.
2. Use the Setup Wizard for successful installation.

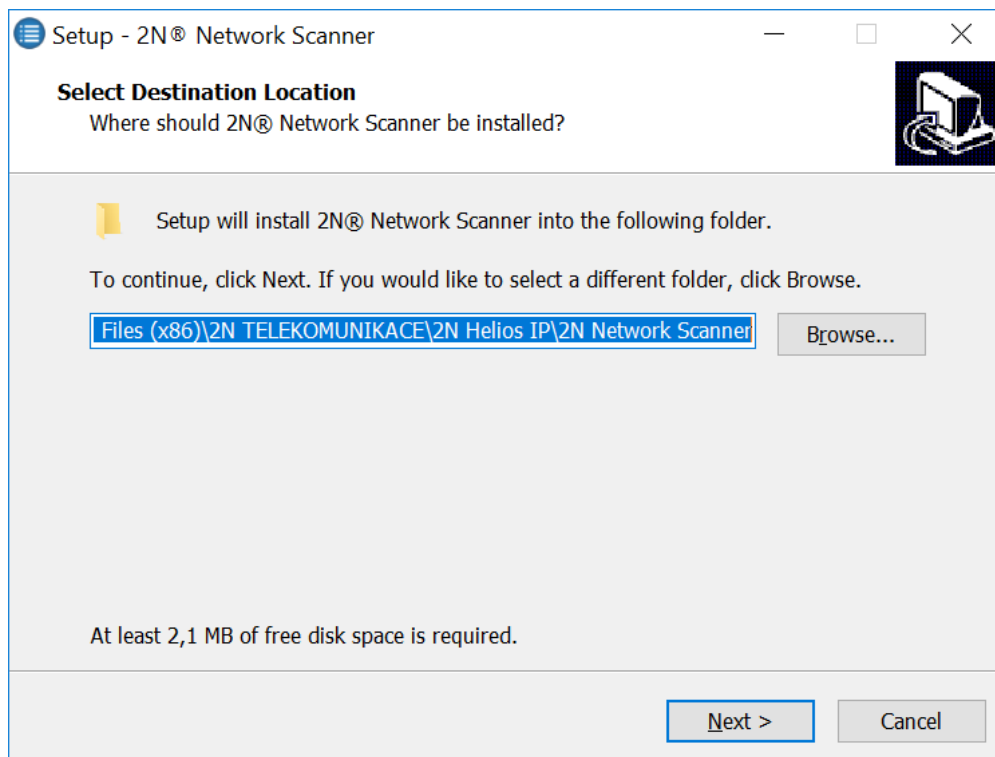

### 2N® IP Network Scanner Installer

3. Having installed the **2N® IP Network Scanner**, start the application using the Microsoft Windows Start menu.

Once started, the application begins to automatically search for all the **2N IP intercoms** in the LAN including their smart extensions (**2N® Indoor Compact**, **2N® Indoor Talk**, **2N® Indoor Touch**), which are DHCP/statically assigned IP addresses. All the devices are displayed in a table.

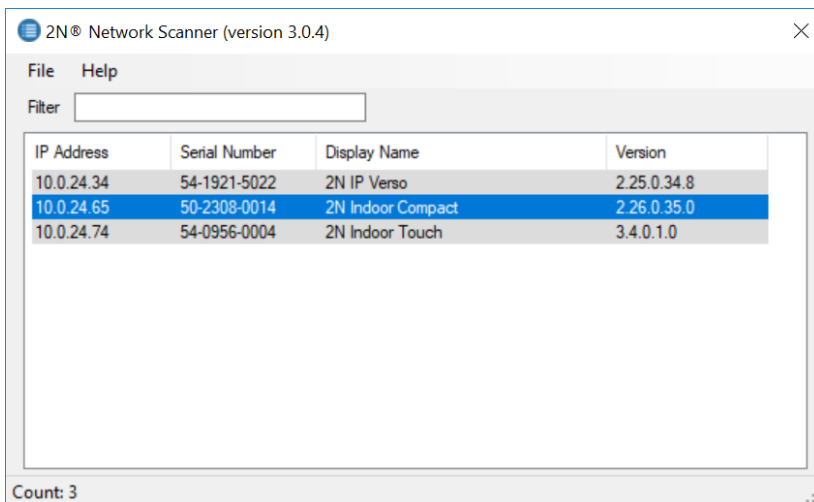

### 2N® IP Network Scanner

1. Select the **2N® Indoor Compact** device to be configured and right-click it. Select *Browse.....* to open the **2N® Indoor Compact** administration web interface login window for configuration. To change the device IP address, select *Config* and enter the required static IP address or activate DHCP. The default configuration password is 2n. If the found device is grey highlighted, its IP address cannot be configured using this application. In that case, click Refresh to find the device again and check whether multicast is enabled in your network.

#### ✓ Tip

- Double click the selected row in the **2N® IP Network Scanner** list to access the device web interface easily.

### 2N® IP Network Scanner IP Address Change

## 2.5 IP Address Lookup

To look up the device IP address, take the following steps: Use the free **2N® Network Scanner** application or view the information on the device display.

To find the **2N® Indoor Compact** IP address via the **2N® Network Scanner**, follow the steps mentioned in the previous subsection, [2.4 2N® Indoor Compact LAN Location via 2N® Network Scanner](#). Once started, the application begins to automatically search for all the **2N IP intercoms** in the LAN including their smart extensions (**2N® Indoor Compact**, **2N® Indoor Talk**, **2N® Indoor Touch**), which are DHCP/statically assigned IP addresses. All the devices are displayed in a table including the IP addresses assigned to them.

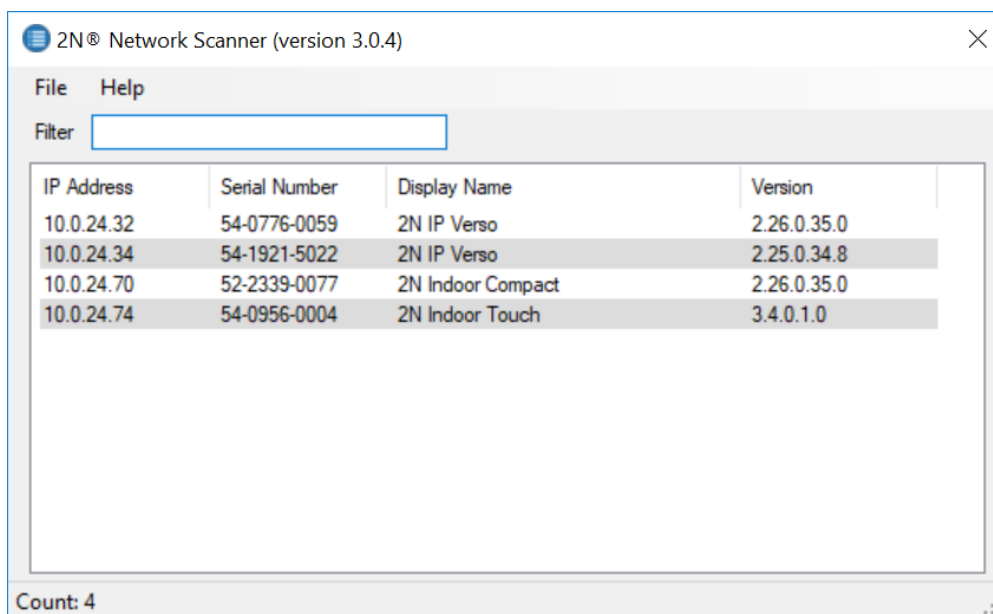

The screenshot shows the '2N® Network Scanner (version 3.0.4)' application window. It has a menu bar with 'File' and 'Help', and a 'Filter' input field. Below is a table with four columns: 'IP Address', 'Serial Number', 'Display Name', and 'Version'. The table contains four rows of data. At the bottom left, it says 'Count: 4'.

| IP Address | Serial Number | Display Name      | Version     |
|------------|---------------|-------------------|-------------|
| 10.0.24.32 | 54-0776-0059  | 2N IP Verso       | 2.26.0.35.0 |
| 10.0.24.34 | 54-1921-5022  | 2N IP Verso       | 2.25.0.34.8 |
| 10.0.24.70 | 52-2339-0077  | 2N Indoor Compact | 2.26.0.35.0 |
| 10.0.24.74 | 54-0956-0004  | 2N Indoor Touch   | 3.4.0.1.0   |

To find the **2N® Indoor Compact** IP address using the display, press any key on the display to quit the sleep mode. Click the right-hand lower button at the  icon on the home screen to display the Settings menu. Find the IP address information in the Settings / System / About device menu.

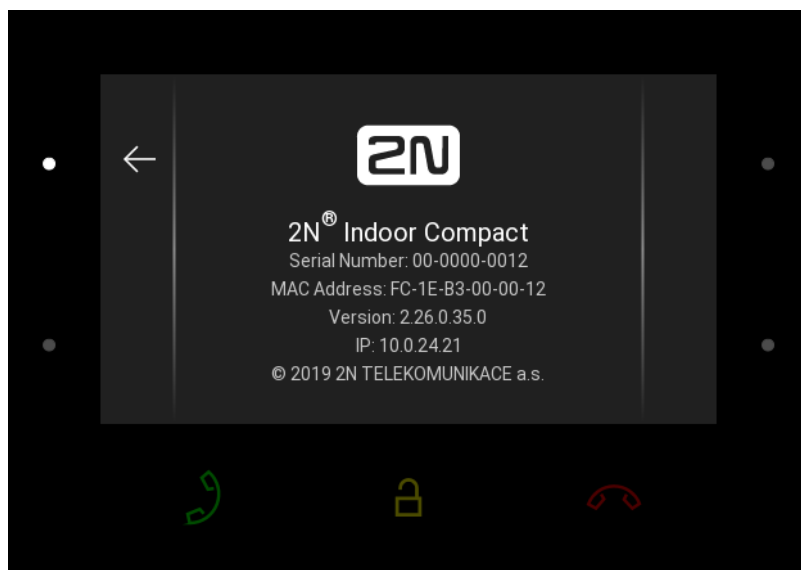

## Dynamic/Static IP Address Switching

To be connected to the LAN properly, **2N® Indoor Compact** has to be assigned a valid IP address or obtain the IP address from the LAN DHCP server. Configure the IP address and DHCP in the System / Network menu.

Použít DHCP server

- **Use DHCP server** – enable automatic obtaining of the IP address from the LAN DHCP server. If there is no DHCP server or the DHCP cannot be used in your network, use the manual network setting.

Manuální nastavení ▾

|                    |               |
|--------------------|---------------|
| Statická IP adresa | 192.168.33.79 |
| Síťová maska       | 255.255.255.0 |
| Výchozí brána      | 192.168.1.1   |
| Primární DNS       | 192.168.23.5  |
| Sekundární DNS     |               |

- **Static IP address** – static IP address of the device. The address is used together with the parameters below unless Use DHCP server is enabled.
- **Network mask** – set the network mask.

- **Default gateway** – address of the default gateway, which provides communication with off-LAN equipment.
- **Primary DNS** – primary DNS address for domain name-to-IP address translation.
- **Secondary DNS** – secondary DNS address where the primary DNS is unavailable.

## 3. Configuration

- [3.1 Factory Reset](#)
- [3.2 Software Configuration](#)

### Login

Fill in the **2N® Indoor Compact** address or domain name into the internet browser to display the login screen. The default login user name and password are as follows:

- Username: **Admin**
- Password: **2n**

Should the login screen fail to appear, you must have typed a wrong IP address/port or the **2N® Indoor Compact** administration web server has been switched off. To find the correct IP address, use the **2N® Network Scanner** as described in [2.4 2N® Indoor Compact LAN Location via 2N® Network Scanner](#).

### Language Selection

Use the menu in the right-hand upper corner of the web interface to select language.

2N Indoor Compact CZ | EN | DE | FR | IT | ES | RU Log out

Language Selection

## 3.1 Factory Reset

### Reset Button

Located among the main unit connectors, the Reset button helps you reset the factory default values, restart the device, find the device IP address and switch the static/dynamic mode.

### IP Address Finding

Follow the instructions below to **identify the current IP address**:

- Press and hold the RESET button.
- Wait until the red and green LEDs go on simultaneously on the device and the acoustic signal  can be heard (approx. 15–35 s).
- Release the RESET button.
- The device automatically announces the current IP address.

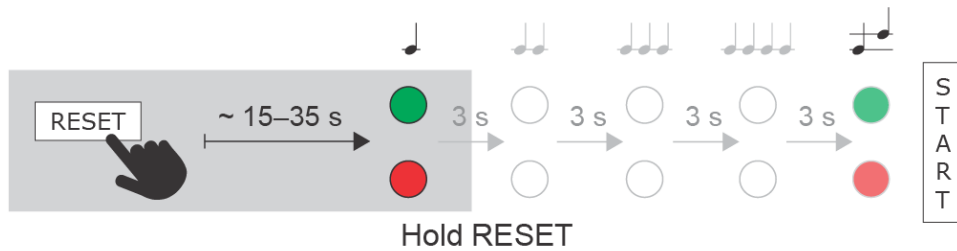



### **Note**

- The delay after pressing RESET till the first light and sound signalling is set to 15–35 s depending on the 2N IP intercom/answering unit model used.
- 15 s is the valid value for **2N® Indoor Compact**.

## Static IP Address Setting

Follow the instructions below to switch on the **Static IP address** mode (DHCP OFF):

- Press and hold the RESET button.
- Wait until the red and green LEDs go on simultaneously on the device and the acoustic signal  can be heard (approx. 15–35 s).
- Wait until the red LED goes off and the acoustic signal  can be heard (approx. for another 3 s).
- Release the RESET button.

The following network parameters will be set after restart:

- IP address: 192.168.1.100
- Network mask: 255.255.255.0
- Default gateway: 192.168.1.1



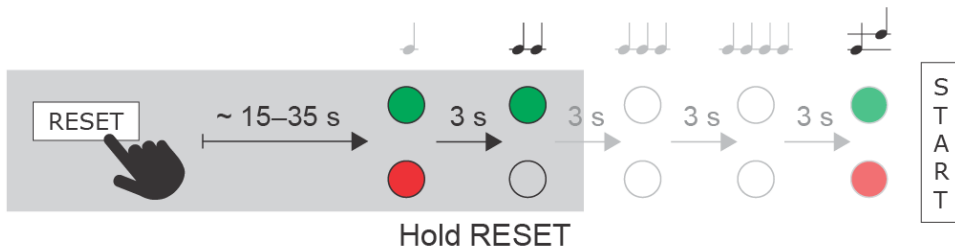

### Dynamic IP Address Setting

Follow the instructions below to switch on the **Dynamic IP address** mode (DCHP ON):



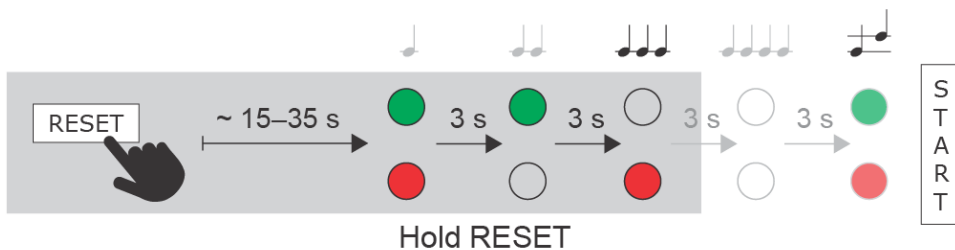

- Press and hold the RESET button.
- Wait until the red and green LEDs go on simultaneously on the device and the acoustic signal can be heard (approx. 15–35 s).
- Wait until the red LED goes off and the acoustic signal can be heard (approx. for another 3 s).
- Wait until the green LED goes off and the red LED goes on again and the acoustic signal can be heard (approx. for another 3 s).
- Release the RESET button.



### Factory Reset

Follow the instructions below to **reset the factory default values**:

- Press and hold the RESET button.

- Wait until the red and green LEDs go on simultaneously and the acoustic signal  can be heard (approx. 15–35 s).
- Wait until the red LED goes off and the acoustic signal  can be heard (approx. for another 3 s).
- Wait until the green LED goes off and the red LED goes on again and the acoustic signal  can be heard (approx. for another 3 s).
- Wait until the red LED goes off and the acoustic signal  can be heard (approx. for another 3 s).
- Release the RESET button.

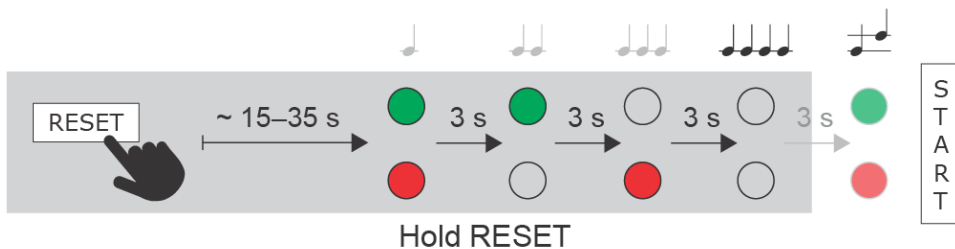

## Device Restart

Press the RESET button shortly (< 1 s) to restart the system without changing configuration.



**i Note**

- The time interval between the short press of RESET and reconnection after restart is 18 s for **2N® Indoor Compact**.

## 3.2 Software Configuration



### Start Screen

The start screen gets displayed when you have logged in to the **2N® Indoor Compact** web interface. Use the button  in the left-hand upper corner on each of the following web interface pages to return to this screen anytime. The screen header includes the device name (refer to the Display Name parameter in the Services / Phone / SIP menu). Use the buttons to select the web interface languages. Click the Log out button in the right-hand upper corner to log out.

The start screen also provides the first menu level and quick tile navigation to selected **2N® Indoor Compact** configuration sections. Some tiles also display the state of selected services.

- [3.2.1 Status](#)
- [3.2.2 Directory](#)
- [3.2.3 Services](#)
- [3.2.4 Hardware](#)
- [3.2.5 System](#)

### 3.2.1 Status

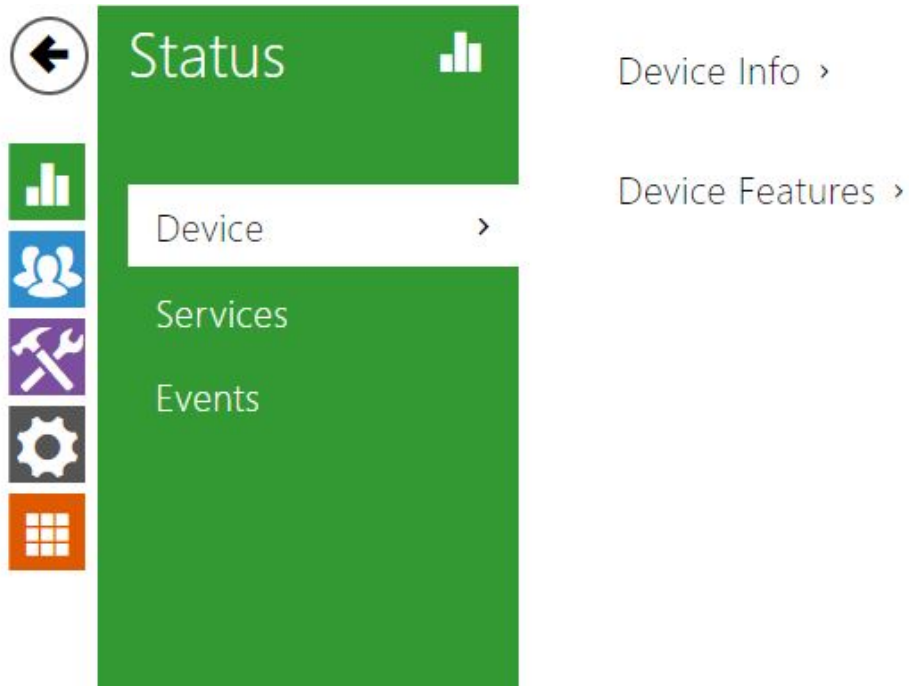

The **Status** menu provides clear status and other current information on the device. The menu consists of three tabs: **Device**, **Services** and **Events**.

- [3.2.1.1 Device](#)
- [3.2.1.2 Services](#)
- [3.2.1.3 Events](#)

## 3.2.1.1 Device

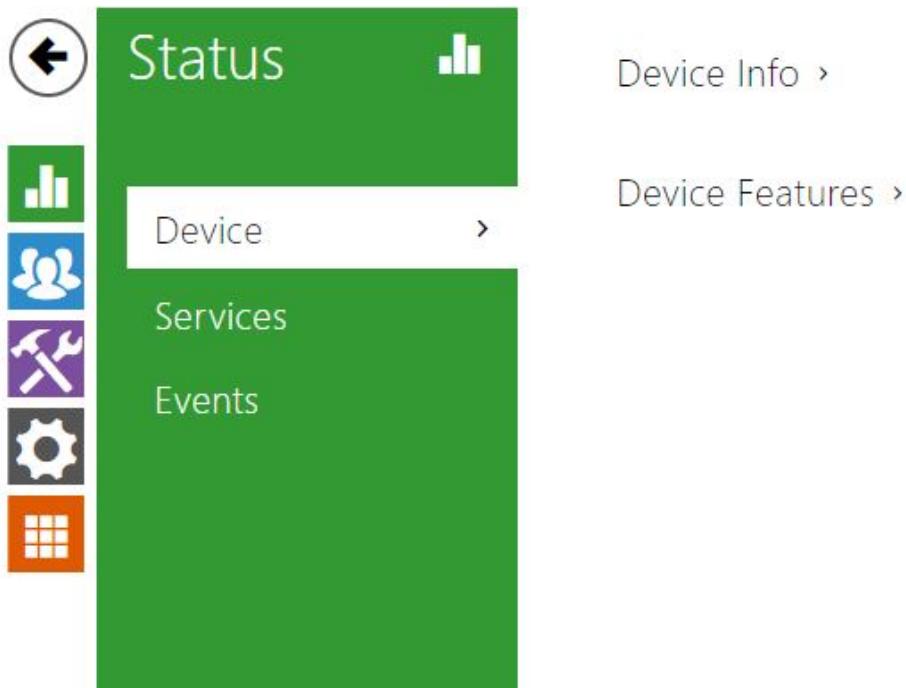

## Device

The tab displays information on the model, its features, firmware and bootloader versions, etc.



- **Factory Certificate Installed** – specify the user certificate and private key to validate the intercom right to communicate with the ACS.
- **Locate device** – optical and acoustic signalling of a device. Optical signalling is possible only if the device is equipped with control backlight (**2N® IP Verso**, **2N® IP Solo**, **2N® IP**

**Base, 2N® IP Vario, 2N® IP Force, 2N® IP Safety a 2N® IP Uni, 2N® Indoor Compact, 2N® Indoor Talk, 2N® Indoor Touch, 2N® IP Indoor Toouch 2.0** ). If a speaker is not integrated in the device, make sure than an external speaker is connected (**2N® IP Audio Kit** and **2N® IP Video Kit**) to use sound signalling.

### 3.2.1.2 Services

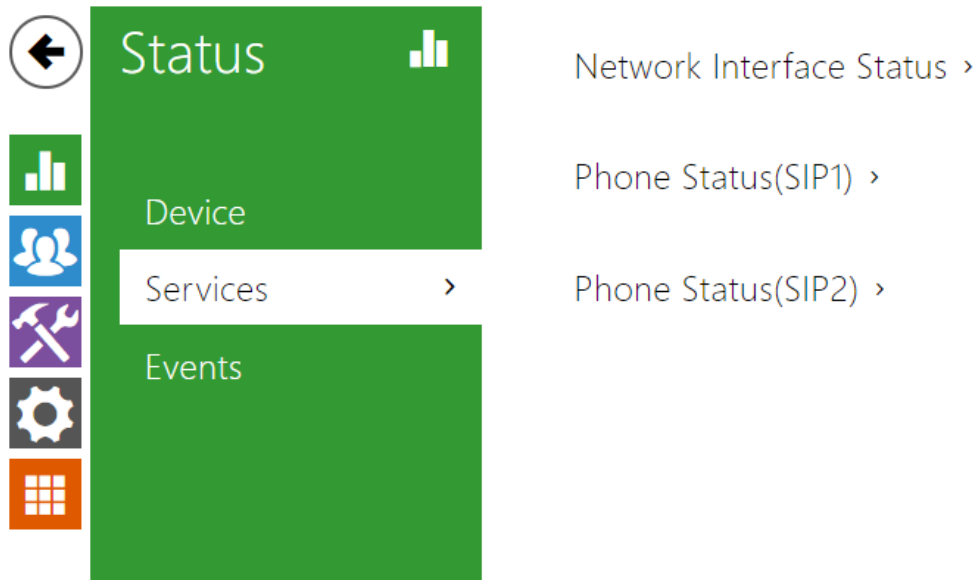

### Services

The Services tab displays the status of the network interface and selected services.

Network Interface Status ▾

- MAC Address **7C-1E-B3-03-9C-29**
- DHCP Status **USED**
- IP Address **10.0.24.70**
- Network Mask **255.255.255.0**
- Default Gateway **10.0.24.1**
- Primary DNS **10.0.100.101**
- Secondary DNS **10.0.100.102**

Phone Status (SIP1) ▾

- Phone Number (ID) **111**
- Registration State **NOT REGISTERED**
- Failure Reason -
- Registrar Address
- Last Registration Time **N/A**



Phone Status (SIP2) ▾

Phone Number (ID) **7203813080**

Registration State **REGISTERED**

Failure Reason -

Registrar Address **proxy-4.my2n.com**

Last Registration Time **2019-03-21 08:03:13**

### 3.2.1.3 Events

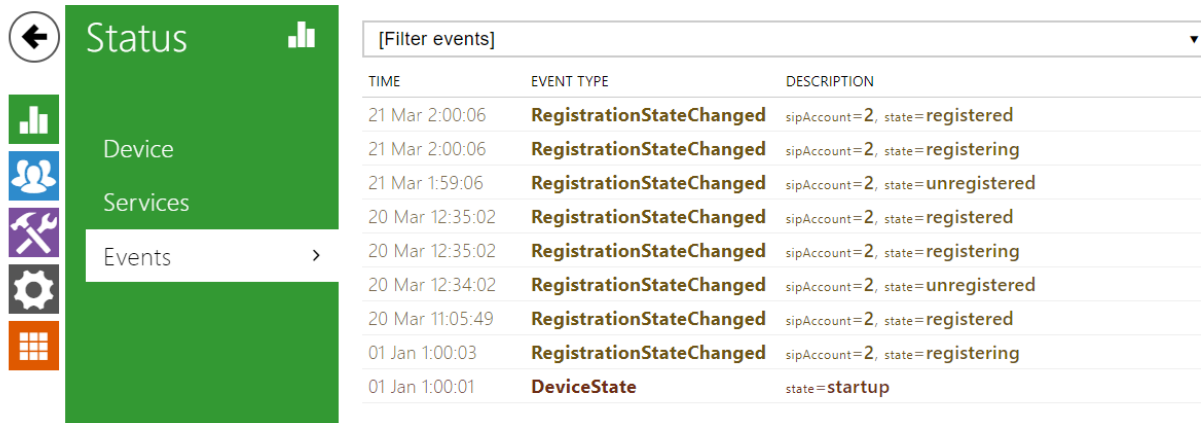

| TIME            | EVENT TYPE                      | DESCRIPTION                      |
|-----------------|---------------------------------|----------------------------------|
| 21 Mar 2:00:06  | <b>RegistrationStateChanged</b> | sipAccount=2, state=registered   |
| 21 Mar 2:00:06  | <b>RegistrationStateChanged</b> | sipAccount=2, state=registering  |
| 21 Mar 1:59:06  | <b>RegistrationStateChanged</b> | sipAccount=2, state=unregistered |
| 20 Mar 12:35:02 | <b>RegistrationStateChanged</b> | sipAccount=2, state=registered   |
| 20 Mar 12:35:02 | <b>RegistrationStateChanged</b> | sipAccount=2, state=registering  |
| 20 Mar 12:34:02 | <b>RegistrationStateChanged</b> | sipAccount=2, state=unregistered |
| 20 Mar 11:05:49 | <b>RegistrationStateChanged</b> | sipAccount=2, state=registered   |
| 01 Jan 1:00:03  | <b>RegistrationStateChanged</b> | sipAccount=2, state=registering  |
| 01 Jan 1:00:01  | <b>DeviceState</b>              | state=startup                    |

### Events

The tab displays the last 500 events captured by the device. Every event includes the capturing time and date, event type and detailed description. The events can be filtered by type in a dropdown menu above the event log.

| TIME            | EVENT TYPE                      | DESCRIPTION                      |
|-----------------|---------------------------------|----------------------------------|
| 21 Mar 2:00:06  | <b>RegistrationStateChanged</b> | sipAccount=2, state=registered   |
| 21 Mar 2:00:06  | <b>RegistrationStateChanged</b> | sipAccount=2, state=registering  |
| 21 Mar 1:59:06  | <b>RegistrationStateChanged</b> | sipAccount=2, state=unregistered |
| 20 Mar 12:35:02 | <b>RegistrationStateChanged</b> | sipAccount=2, state=registered   |
| 20 Mar 12:35:02 | <b>RegistrationStateChanged</b> | sipAccount=2, state=registering  |
| 20 Mar 12:34:02 | <b>RegistrationStateChanged</b> | sipAccount=2, state=unregistered |
| 20 Mar 11:05:49 | <b>RegistrationStateChanged</b> | sipAccount=2, state=registered   |
| 01 Jan 1:00:03  | <b>RegistrationStateChanged</b> | sipAccount=2, state=registering  |
| 01 Jan 1:00:01  | <b>DeviceState</b>              | state=startup                    |

























## 3.2.2 Directory

| <input type="checkbox"/> | Type | Name              | Phone Number                | Features |
|--------------------------|------|-------------------|-----------------------------|----------|
| <input type="checkbox"/> |      | 2N Indoor Compact | device:2NIndoorCompact...   |          |
| <input type="checkbox"/> |      | 2N IP Verso       | device:2NIPVerso-5416710... |          |
| <input type="checkbox"/> |      | 2N IP Verso       | device:2NIPVerso-5419215... |          |
| <input type="checkbox"/> |      | Front Door        |                             |          |
| <input type="checkbox"/> |      | IP Verso          | sip:10.0.24.32              |          |
| <input type="checkbox"/> |      | Reception         |                             |          |

Directory is one of the crucial parts of the device configuration. It helps add new devices (2N IP intercoms and other answering units) and provides essential information on them. Up to 200 devices can be added to the directory.

The Search function works as a fulltext search in names and phone numbers. It searches for all matches in the whole directory. The icon helps find registered devices and add them to the Directory list if necessary. The icon helps create a new device and the icon displays the user settings details. The icon helps remove a device from the list deleting all its data.

You can arrange the list according to the name or feature ( indicates that the device may be displayed, indicates that incoming calls are allowed to the device and indicates the feature of the device to which the alarm call started with a doorbell button press is created). One list page can include 15, 25 or 50 devices.

| <input type="checkbox"/> | Type  | Name              | Phone Number                | Features  |
|--------------------------|---|-------------------|-----------------------------|---|
| <input type="checkbox"/> |  | 2N Indoor Compact | device:2NIndoorCompact-...  |    |
| <input type="checkbox"/> |  | 2N IP Verso       | device:2NIPVerso-5416710... |    |
| <input type="checkbox"/> |  | 2N IP Verso       | device:2NIPVerso-5419215... |    |
| <input type="checkbox"/> |  | Front Door        |                             |    |
| <input type="checkbox"/> |  | IP Verso          | sip:10.0.24.32              |    |
| <input type="checkbox"/> |  | Reception         |                             |    |

15 ▾ 1 - 6 (Total 6) 1

Each device list item includes the following data:

Basic Settings ▾

Device Name

Displayed Icon

Device Type

Phone Number

Enable Camera Switching

- **Device Name** – enter the device name for the selected Phone Book position. This parameter is optional and helps you find items in the Phone Book more easily.
- **Displayed Icon** – display the reception desk symbol or a standard symbol.
- **Device Type** – set this parameter manually or automatically using the search for registered devices in the directory.
- **Phone Number** – set the phone number for the call to be directed to. Enter sip: [user\_id@]domain[:port] for Direct SIP calling, e.g.: sip:200@192.168.22.15 or sip:name@yourcompany. Enter device:device\_name for calls to the **2N® IP Mobile** application. Set the device name in the mobile application. Enter **/1** or **/2** behind the phone number to specify which SIP account shall be used for outgoing calls (account 1 or 2). Enter **/S** or **/N** to force an encrypted or unencrypted call respectively. The account and encryption selections can be combined into the suffix **/1S**, for example.
- **Enable Camera Switching** – set whether or not an external camera is available at the contact terminal equipment (accordingly, the internal/external camera button is/is not displayed during calls and call previews). With some 2N terminal equipment in the LAN, the information sent by the 2N terminal equipment is preferred to this setting (i.e. this setting is not needed for contacts using 2N terminals or camera-less devices).

Display ▾

Display Device

Display on top

Alternative name

- **Display Device** – display this device. The user can select and call for any device displayed.
- **Display on top** – display the device on the top.
- **Alternative name** – display an alternative name instead of the device name.

**⚠ Caution**

- The <, > and / characters are not allowed for the Device name and Alternative name parameters.

Call Button Function ▾

Start call with a short press

- **Start call with a short press** – a phone call to this device will be set up after a short press of the call button. The entrance door will be unlocked after a short press of the unlock button.

Alarm call ▾

Start call with a doorbell button press

- **Start call with a doorbell button press** – a phone call to this device will be set up after the call button is pressed. Set alarm call activation for the doorbell in the HW / Digital inputs / Doorbell button section.

Unlock Button Function ▾

| BUTTON | NAME                                | LIFT                     | UNLOCK CODE          |
|--------|-------------------------------------|--------------------------|----------------------|
| 1      | <input type="text" value="Lock 1"/> | <input type="checkbox"/> | <input type="text"/> |
| 2      | <input type="text" value="Lock 2"/> | <input type="checkbox"/> | <input type="text"/> |
| 3      | <input type="text" value="Lock 3"/> | <input type="checkbox"/> | <input type="text"/> |

- **Name** – enter the code assigned to unlock button #1, #2, #3.
- **Lift** – select the door lock / lift unlock button icon on the display.

- **Code 1, 2, 3, 4** – It is used for remote unlocking of the entrance door, for example. Make sure that the code includes at least two door unlocking characters via the intercom keypad and at least one door unlocking DTMF character via a phone. The supported characters also include \* or #. Four characters at least are recommended.

### 3.2.3 Services

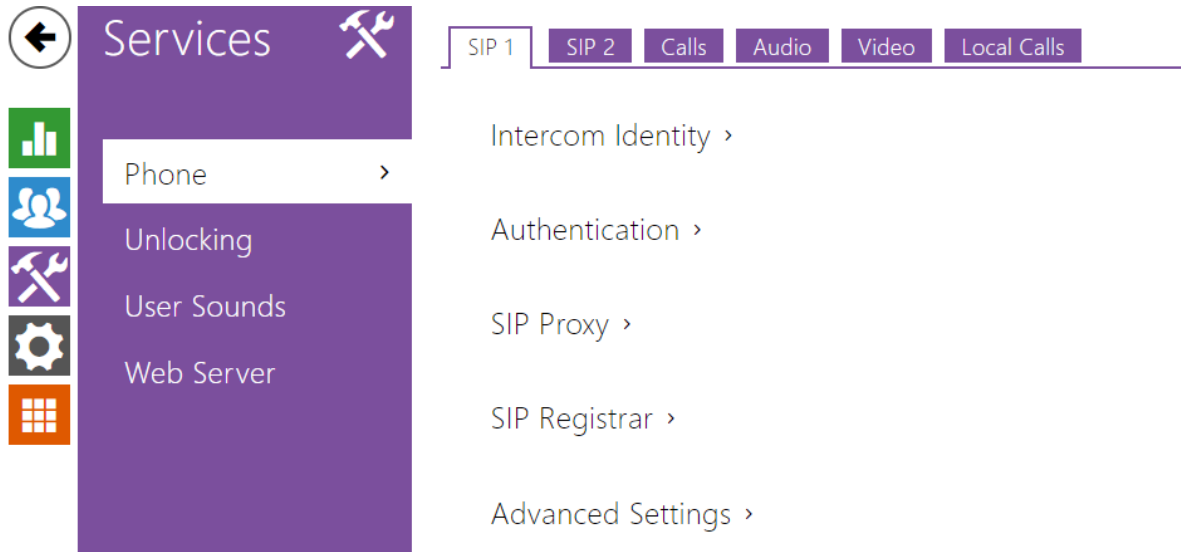

- 2.3.2.3 HTTP Command
- 3.2.3.1 Phone
- 3.2.3.2 Unlocking
- 3.2.3.4 User Sounds
- 3.2.3.5 Web Server

## 3.2.3.1 Phone

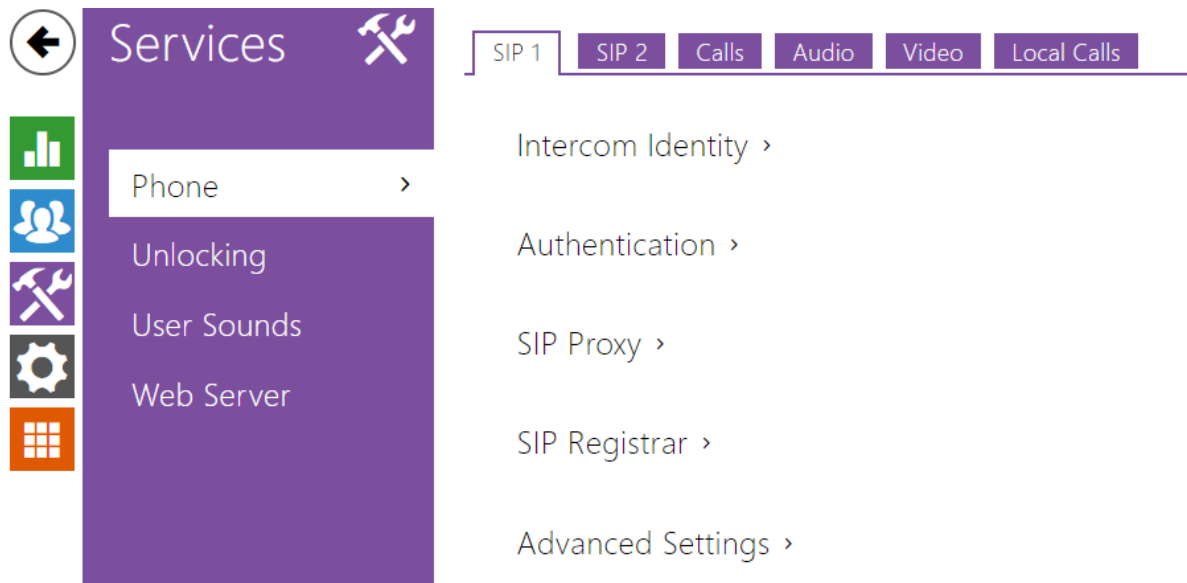

**Phone** is the basic function of **2N® Indoor Compact** allowing you to establish connections with other IP network terminals. **2N® Indoor Compact** supports the extended SIP.

## List of Parameters

**2N® Indoor Compact** Phone includes the following four tabs:

- **SIP 1** – complete SIP account settings.
- **SIP 2** – complete SIP account settings.
- **Calls** – incoming and outgoing call settings.
- **Audio** – audio codec, DTMF and other audio stream parameter transmission settings.
- **Video** – video codec and SDP codec settings.
- **2N Indoor Units** – general parameters and count of identified LAN devices.

## SIP 1 and SIP 2

**2N® Indoor Compact** helps you configure one SIP account.



Intercom Identity ▾

|                   |  |
|-------------------|--|
| Display Name      | <input type="text" value="2N Indoor Compact"/> |
| Phone Number (ID) | <input type="text" value="111"/>               |
| Domain            | <input type="text" value="192.168.1.1"/>       |
|                   | <input type="button" value="Test Call"/>       |

- **Display Name** – set the name to be displayed as CLIP on the called party's phone.
- **Phone Number (ID)** – set your device phone number (or another unique ID composed of characters and digits). Together with the domain, this number uniquely identifies the device in calls and registration.
- **Domain** – set the domain name of the service with which the device is registered. Typically, it is equivalent to the SIP Proxy or Registrar address.
- **Test Call** – display a dialogue window enabling you to make a test call to a selected phone number, see below.

Authentication ▾

|                       |  |
|-----------------------|--|
| Use Authentication ID | <input type="checkbox"/>               |
| Authentication ID     | <input type="text"/>                   |
| Password              | <input type="password" value="....."/> |

- **Use Authentication ID** – select the use of an alternative ID for device authentication. Otherwise, the Phone number value from the previous section is used for authentication.
- **Authentication ID** – set the alternative user ID for device authentication.
- **Password** – set the device authentication password. If your PBX requires no authentication, the parameter will not be applied.

SIP Proxy ▾

|                      |  |
|----------------------|--|
| Proxy Address        | <input type="text" value="192.168.1.1"/> |
| Proxy Port           | <input type="text" value="5060"/>        |
| Backup Proxy Address | <input type="text"/>                     |
| Backup Proxy Port    | <input type="text" value="5060"/>        |

- **Proxy Address** – set the SIP Proxy IP address or domain name.
- **Proxy Port** – set the SIP Proxy port (typically 5060).
- **Backup Proxy Address** – set the backup SIP Proxy IP address or domain name. The address is used where the main proxy fails to respond to requests.
- **Backup Proxy Port** – set the backup SIP Proxy port (typically 5060).

SIP Registrar ▾

|                          |                          |
|--------------------------|--------------------------|
| Registration Enabled     | <input type="checkbox"/> |
| Registrar Address        | 192.168.1.1              |
| Registrar Port           | 5060                     |
| Backup Registrar Address |                          |
| Backup Registrar Port    | 5060                     |
| Registration Expiry      | 120 [s]                  |
| Registration State       | <b>NOT REGISTERED</b>    |
| Failure Reason           | -                        |

- **Registration Enabled** – enable device registration with the set SIP Registrar.
- **Registrar Address** – set the SIP Registrar IP address or domain name.
- **Registrar Port** – set the SIP Registrar port (typically 5060).
- **Backup Registrar Address** – set the backup SIP Registrar IP address or domain name. The address is used where the main registrar fails to respond to requests.
- **Backup Registrar Port** – set the backup SIP registrar port (typically 5060).
- **Registration Expiry** – set the registration expiry, which affects the network and SIP Registrar load by periodically sent registration requests. The SIP Registrar can alter the value without letting you know.
- **Registration State** – display the current registration state (Unregistered, Registering..., Registered, Unregistering...).
- **Failure Reason** – display the reason for the last registration attempt failure: the registrar's last error reply, e.g. 404 Not Found.

Advanced Settings ▾

|                                      |                          |
|--------------------------------------|--------------------------|
| SIP Transport Protocol               | TLS ▾                    |
| Lowest Allowed TLS Version           | TLS 1.0 ▾                |
| Verify Server Certificate            | <input type="checkbox"/> |
| Client Certificate                   | [Signed by device] ▾     |
| Local SIP Port                       | 5060                     |
| PRACK Enabled                        | <input type="checkbox"/> |
| REFER Enabled                        | <input type="checkbox"/> |
| Send KeepAlive Packets               | <input type="checkbox"/> |
| IP Address Filter Enabled            | <input type="checkbox"/> |
| Receive Encrypted Calls Only (SRTP)  | <input type="checkbox"/> |
| Encrypted Outgoing Calls (SRTP)      | <input type="checkbox"/> |
| Do Not Play Incoming Early Media     | <input type="checkbox"/> |
| QoS DSCP Value                       | 0                        |
| External IP Address                  |                          |
| Starting RTP Port                    | 4900                     |
| RTP Timeout                          | 60                       |
| Compatibility with Broadsoft Devices | <input type="checkbox"/> |
| Rotate SRV Records                   | <input type="checkbox"/> |

- **SIP Transport Protocol** – set the SIP communication protocol: UDP (default), TCP or TLS.
- **Lowest Allowed TLS Version** – set the lowest TLS version to be accepted for device connection.
- **Verify Server Certificate** – verify the SIP server public certificate against the CA certificates uploaded in the device.
- **Client Certificate** – specify the client certificate and private key used for verifying the intercom's authority to communicate with the SIP server.
- **Local SIP Port** – set the local port for the device for SIP signaling. A change of this parameter will not be applied until the device is restarted. The default value is 5060.
- **PRACK Enabled** – enable the PRACK method for reliable confirmation of SIP messages with codes 101–199.
- **REFER Enabled** – enable call forwarding via the REFER method.
- **Send Keep Alive Packets** – set that the device shall inquire periodically about the state of the called station via SIP OPTIONS requests during the call (used for station failure detection during the call).

- **IP Address Filter Enabled** – enable the blocking of SIP packet receiving from addresses other than SIP Proxy and SIP Registrar. The primary purpose of the function is to enhance communication security and eliminate unauthorized phone calls.
- **Receive encrypted calls only (SRTP)** – set that SRTP encrypted calls shall only be received on this account. Unencrypted calls will be rejected. At the same time, TLS is recommended as the SIP transport protocol for higher security.
- **Encrypted outgoing calls (SRTP)** – set that outgoing calls shall be SRTP encrypted on this account. At the same time, TLS is recommended as the SIP transport protocol for higher security.
- **Do Not Play Incoming Early Media** – disable playing of the incoming audio stream before the call sent by some PBXs or other devices is picked up (early media). A standard local ringtone is played instead.
- **QoS DSCP Value** – set the SIP packet priority in the network. The set value is sent in the TOS (Type of Service) field in the IP packet header. Enter the value as a decimal number. A change of this parameter will not be applied until the device is restarted.
- **External IP Address** – set the public IP address or router name to which the device is connected. If the device IP address is public, leave this parameter empty.
- **Starting RTP Port** – set the initial local RTP port in the range of 64 ports used for audio and video transmission. The default value is 4900 (i.e. the range is 4900–4963). The parameter is only set for account 1 but applies to both the SIP accounts.
- **RTP Timeout** – set the audio stream RTP packet receiving timeout during a call. If this limit is exceeded (RTP packets are not delivered), the call will be terminated by the device. Enter 0 to disable this parameter. The parameter is only set for account 1 but applies to both the SIP accounts.
- **Broadsoft Compatibility Mode** – set the Broadsoft PBX compatibility mode. Having received re-invite from a PBX in this mode, the intercom replies by repeating the last sent SDP with currently used codecs instead of sending a complete offer.
- **Rotate SRV Records** – allow SRV record rotation for SIP Proxy and Registrar. This is an alternative method of transition to backup servers in the event of main server failure or unavailability.

## Calls

General Settings ▾

Call Time Limit  [s]

- **Call Time Limit** – set the call time limit after which the call is automatically terminated. The intercom signals termination with a beep 10 s before the call end. Enter any DTMF character into the call (# on your IP phone, e.g.) to extend the call time.

Incoming Calls ▾

|                            |                 |
|----------------------------|-----------------|
| Call Answering Mode (SIP1) | Manual Pickup ▾ |
| Call Answering Mode (SIP2) | Automatic ▾     |
| Local Call Receiving Mode  | Manual Pickup ▾ |
| Pick up in                 | 0 [s]           |

- **Call Answering Mode (SIP 1, SIP 2)** – set the way of receiving incoming calls. The following three options are available:
  - **Always busy** – the device rejects incoming calls.
  - **Manual Pickup** – the device rings to signal incoming calls and the user can press a keypad button to pick up.
  - **Automatic** – the device picks up incoming calls automatically. You can set the call receiving mode for each SIP account separately.
- **Local Call Receiving Mode** – set the way of receiving incoming local calls. The following three options are available:
  - **Always busy** – the device rejects incoming calls.
  - **Manual Pickup** – the device rings to signal incoming calls and the user can press a keypad button to pick up.
  - **Automatic** – the device picks up incoming calls automatically. You can set the call receiving mode for each SIP account separately.
- **Pick up in** – this parameter is only active when the Automatic pickup mode is enabled. The call is picked up automatically after the preset timeout elapses.

Outgoing Calls ▾

|                 |        |
|-----------------|--------|
| Ring Time Limit | 32 [s] |
|-----------------|--------|

- **Ring Time Limit** – set the maximum call setup and ringing time in which all outgoing calls are automatically terminated. If the calls are routed to the GSM network via GSM gateways, you are advised to set a value longer than 20 s. Minimum value: 1 s, maximum value: 600 s. Set 0 to disable the time parameter.

Call Log ▾

Save Image during Call

- **Save Image during Call** – if enabled, one snapshot is automatically taken from each video call and saved into the call log.

#### ⚠ Caution

- If the Save Image during Call function is disabled, all the snapshots will be deleted while the call logs will be preserved.

## Audio

Audio Codecs ▾

| CODEC        | ENABLED                             | PRIORITY      |
|--------------|-------------------------------------|---------------|
| PCMU         | <input checked="" type="checkbox"/> | 2 ▾           |
| PCMA         | <input checked="" type="checkbox"/> | 1 (highest) ▾ |
| L16 / 16 kHz | <input type="checkbox"/>            | 4 ▾           |
| G.729        | <input checked="" type="checkbox"/> | 3 ▾           |
| G.722        | <input checked="" type="checkbox"/> | 1 (highest) ▾ |

- Enable/disable the use of audio codecs for call setups and set their priorities.

DTMF Sending ▾

In-Band (Audio)

RTP (RFC-2833)

SIP INFO (RFC-2976)

The tab helps you define how DTMF characters shall be sent from the intercom. Check the DTMF receiving options and settings of the opponent to make the function work properly.

- **In-Band (Audio)** – enable classic DTMF dual tone sending in the audio band.
- **RTP (RFC-2833)** – enable DTMF sending via the RTP according to RFC-2833.
- **SIP INFO (RFC-2976)** – enable DTMF sending via SIP INFO messages according to RFC-2976.

DTMF Receiving ▾

In-Band (Audio)

RTP (RFC-2833)

SIP INFO (RFC-2976)

The tab helps you define how DTMF characters shall be received from the intercom. Check the opponent's DTMF receiving options and settings to make the function work properly.

- **In-Band (Audio)** – enable classic DTMF dual tone receiving in the audio band.
- **RTP (RFC-2833)** – enable DTMF receiving via RTP according to RFC-2833.
- **SIP INFO (RFC-2976)** – enable DTMF receiving via SIP INFO messages according to RFC-2976.

Transmission Quality Settings ▾

QoS DSCP Value

Jitter Compensation

- **QoS DSCP Value** – set the audio RTP packet priority in the network. The set value is sent in the TOS (Type of Service) field in the IP packet header.
- **Jitter Compensation** – set the buffer length for compensation of interval unevenness in audio packet arrivals. A higher capacity improves the transmission resistance at the cost of a greater sound delay.

## Video

Video Codecs ▾

| CODEC | ENABLED                             | PRIORITY      |
|-------|-------------------------------------|---------------|
| H.264 | <input checked="" type="checkbox"/> | 1 (highest) ▾ |

- Enable/disable the use of video codecs for call setups and set their priorities.

Advanced SDP Settings ▾

H.264 Payload Type (1)

H.264 Payload Type (2)

- **H.264 Payload Type (1), (2)** – set the video codec H.264 payload type (packetization mode 1). Set a value from the range of 96 through 127, or 0 to disable this codec type.

## Local Calls

Enable Local Calls

- **Enable Local Calls** – enable calls between devices in the LAN. With this function off, the other LAN devices cannot locate this device, i.e. cannot call the device in the device:device\_ID format.

Network Identification ▾

Device ID

- **Device ID** – Set the device ID to be displayed in the LAN device list in all the 2N devices in one and the same LAN. You can direct a call to this device by setting the user phone number as device:device\_ID in these devices.



Connection to Intercoms ▾

Access Key 1

Access Key 2

- **Access Key 1, 2** – set the access key shared by the 2N answering units and intercoms. If the keys in the 2N answering units and intercoms fail to match, the device cannot communicate, i.e. the intercom cannot call the 2N answering unit and vice versa.

Connection to answering units ▾

Access Key

Multicast Address

- **Access Key** – set the access key shared by the 2N answering units. If the keys in the 2N answering units fail to match, the answering units cannot communicate, i.e. the answering units cannot call each other.
- **Multicast Address** – set the network multicast address to which the answering unit message shall be sent.

LAN Devices ▾

LAN Device Count **2**

Show LAN device list

- **LAN Device count** – display the number of local devices in the network.
- **Show LAN devices list** – display a detailed list of local devices in the network.

## 3.2.3.2 Unlocking

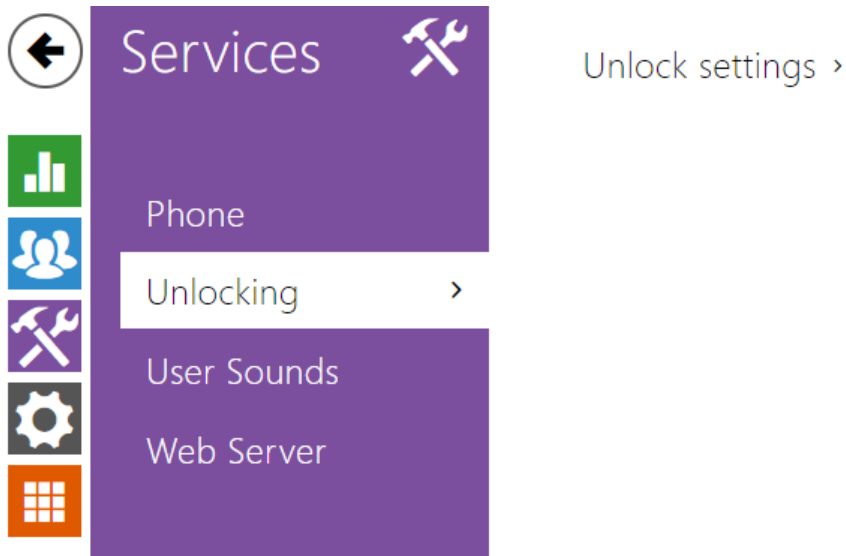

**Unlocking** is another function of **2N® Indoor Compact**, which sets the remote door unlocking parameters.

Unlock settings ▾

Default Unlock Code

Hang up after door unlocking

Hang-up delay  [s]

- **Default Unlock Code** – use this code when a call has been set up with a device/phone number that is not added to the unit phone book.
- **Hang up After Door Unlocking** – end the call when the door unlocking request has been sent successfully.
- **Hang-up delay** – end the call when the door unlocking request sending timeout has elapsed.

## 2.3.2.3 HTTP Command

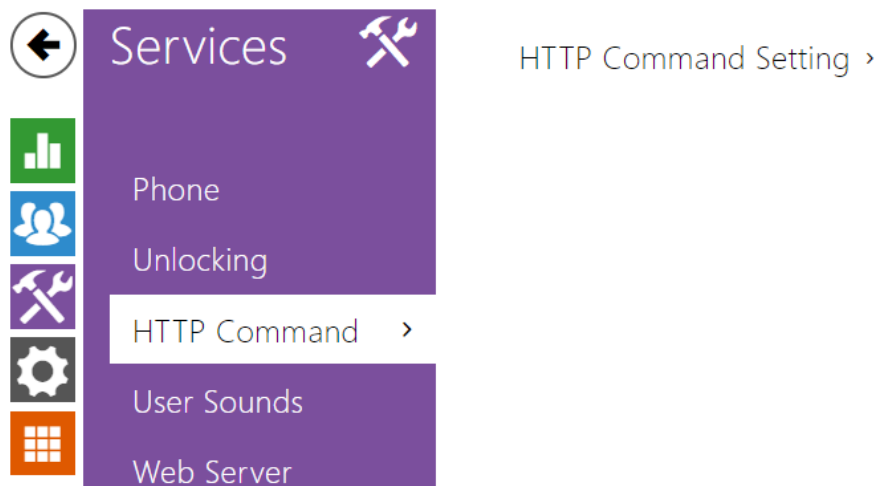

HTTP příkaz na odpovídací jednotce **2N® Indoor Compact** slouží k odesílání až 3 zvolených HTTP příkazů pomocí stisku tlačítka. Dlouhým stiskem tlačítka zámku budou na displeji zobrazena dostupná tlačítka příslušných HTTP příkazů v případě, že je funkce nastavena.

HTTP Command Setting ▾

| COMMAND | URL                  | ICON      | NAME                 | USERNAME             | PASSWORD             |
|---------|----------------------|-----------|----------------------|----------------------|----------------------|
| 1       | <input type="text"/> | Bulb ▾    | <input type="text"/> | <input type="text"/> | <input type="text"/> |
| 2       | <input type="text"/> | Speaker ▾ | <input type="text"/> | <input type="text"/> | <input type="text"/> |
| 3       | <input type="text"/> | Lift ▾    | <input type="text"/> | <input type="text"/> | <input type="text"/> |

- **URL** – set the HTTP command to be sent to an external device by pressing a button. The command is sent via the HTTP (GET request). The command format is [http://ip\\_address/path](http://ip_address/path). E.g. <http://192.168.1.50/relay1=on>. If the parameter is empty, the command is not sent.
- **Icon** – choose the HTTP command button icon. The button is displayed on the device home page and can be used for sending the set HTTP command.
- **Jméno** – uživatelské pojmenování HTTP příkazu.
- **Username** – set the user name for authentication of the HTTP command to be sent by pressing a button. The parameter is mandatory only if the requested device requires authentication.
- **Password** – set the password for authentication of the HTTP command to be sent by pressing a button. The parameter is mandatory only if the requested device requires authentication.

### 3.2.3.4 User Sounds

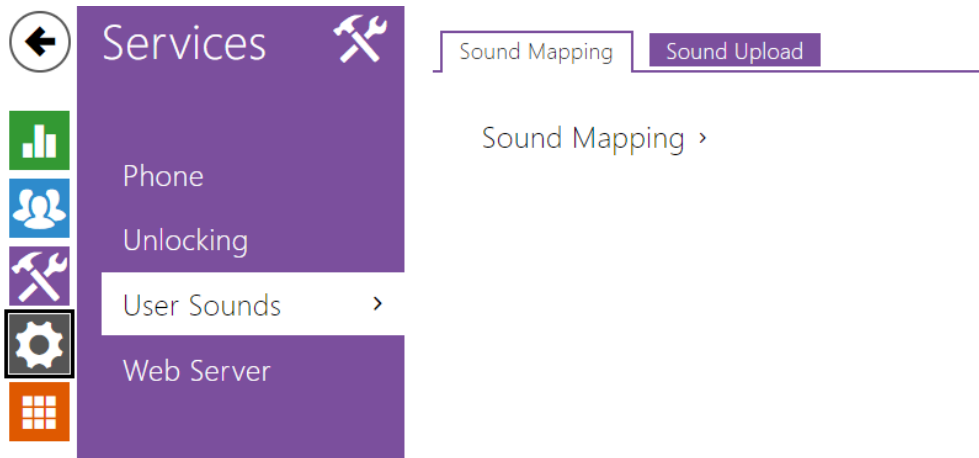

**2N® Indoor Compact** signals variable operational statuses with a sequence of tones. If the standard signaling tones do not meet your requirements, you can modify them.

The device allows you to modify sound signaling for the following states:

- a. **Ringtone before call pickup**
- b. **Ringing tone**
- c. **Busy tone**
- d. **Call end signaling**
- e. **Doorbell**

## Sound Mapping

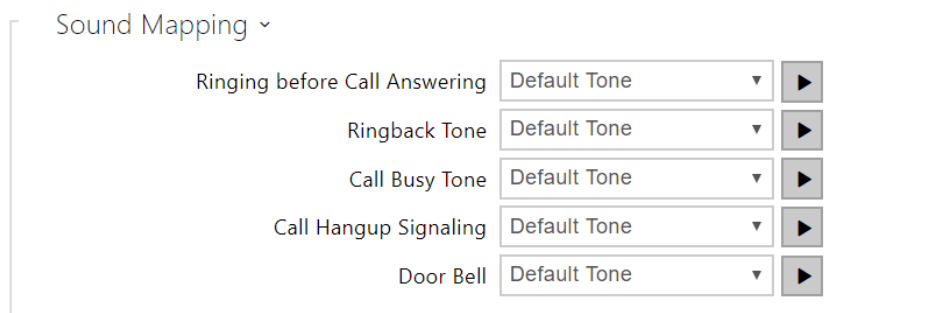

- **Ringing before Call Pickup** – set the ringtone to be played before an incoming call is picked up (device ringtone).

- **Ringback Tone** – set the sound to be played when the called user is ringing. The PBX ringtone is preferred to the user ringtone in the device.
- **Call Busy Tone** – set the tone to be played when the called user is busy.
- **Call Hang-Up Signaling** – set the tone to signal the call end.
- **Doorbell** – set the tone to be played when the doorbell is used.

## Sound Upload

Sound Upload ▾

|    | NAME                                       | SIZE |  |  |  |  |
|----|--|------|--|--|--|--|
| 1  | <input type="text" value="User sound 1"/>  | N/A  |  |  |  |  |
| 2  | <input type="text" value="User sound 2"/>  | N/A  |  |  |  |  |
| 3  | <input type="text" value="User sound 3"/>  | N/A  |  |  |  |  |
| 4  | <input type="text" value="User sound 4"/>  | N/A  |  |  |  |  |
| 5  | <input type="text" value="User sound 5"/>  | N/A  |  |  |  |  |
| 6  | <input type="text" value="User sound 6"/>  | N/A  |  |  |  |  |
| 7  | <input type="text" value="User sound 7"/>  | N/A  |  |  |  |  |
| 8  | <input type="text" value="User sound 8"/>  | N/A  |  |  |  |  |
| 9  | <input type="text" value="User sound 9"/>  | N/A  |  |  |  |  |
| 10 | <input type="text" value="User sound 10"/> | N/A  |  |  |  |  |

You can upload up to 10 user sound files to the device and name each of them for better orientation.

Press to upload a sound file to the device. Select a file from your PC and click **Upload**. Press to remove a file. Click to play a successfully uploaded sound file (locally on your PC).

Press to record a sound file via your PC microphone.

## 3.2.3.5 Web Server

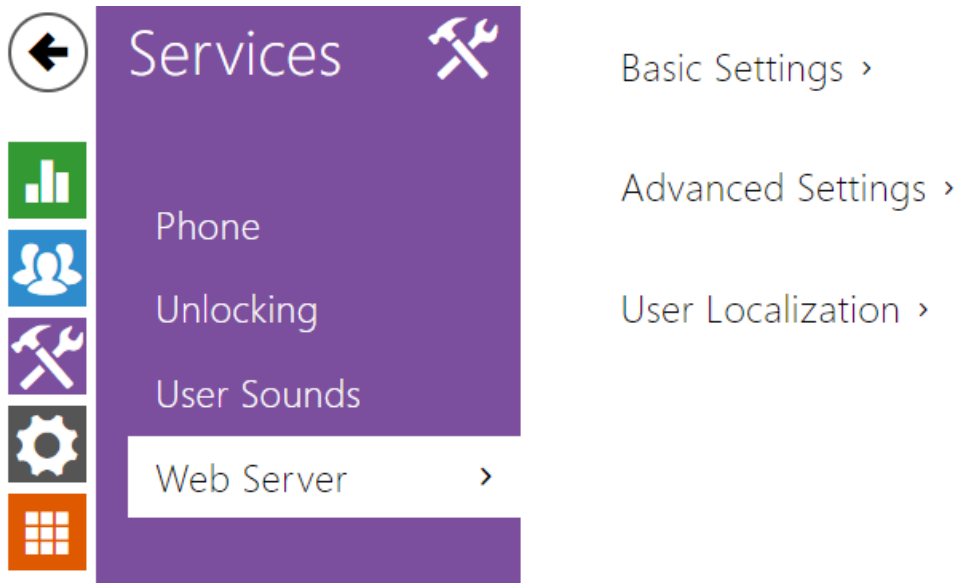

**2N® Indoor Compact** can be configured using a common browser that approaches the web server integrated in the device. The HTTPS protocol is used for the browser - device communication. Enter the login user name and password first. The default values are **admin** and **2n** respectively. We recommend to you change the default password as soon as possible.

## List of Parameters

Basic Settings ▾

|                        |   |
|------------------------|---|
| Device Name            | <input type="text" value="2N Indoor Compact"/>  |
| Web Interface Language | <input type="text" value="English"/> ▾  |
| Password               | <input type="password" value="....."/>  |

- **Device Name** – set the device name to be displayed in the right-hand upper corner of the web interface, in the login window and in other applications if necessary (Network Scanner, etc.)
- **Web Interface Language** – set the default language after the administration web server login. Use the upper toolbar buttons to change the web interface language temporarily any time.





- **Password** – set the device login password. Click  to edit the password. Make sure that the password contains 8 characters at least, including one small alphabet letter, one capital alphabet letter and one digit.

Advanced Settings ▾

|                            |  |
|----------------------------|--|
| HTTP Port                  | <input type="text" value="80"/>            |
| HTTPS Port                 | <input type="text" value="443"/>           |
| Lowest Allowed TLS Version | <input type="text" value="TLS 1.0"/> ▾     |
| HTTPS User Certificate     | <input type="text" value="Self Signed"/> ▾ |
| Remote Access Enabled      | <input checked="" type="checkbox"/>        |

- **HTTP Port** – set the web server port for HTTP communication. The port change will not be applied until the device is restarted.
- **HTTPS Port** – set the web server port for HTTPS communication. The port change will not be applied until the device is restarted.
- **Minimum Allowed TLS Version** – set the lowest TLS version to be accepted for device connection.
- **HTTPS User Certificate** – set the user certificate and private key for communication encryption between the device HTTP server and the user web browser. Choose one of the three sets of user certificates and private keys (refer to the Certificates subs.) or keep the **Self Signed** setting, in which the certificate automatically generated upon the first intercom power up is used.
- **Remote Access Enabled** – enable remote access to the device web server from off-LAN IP addresses.

User Localization ▾

| FILE              | SIZE   |   |
|-------------------|--------|---|
| Original Language | 218 kB |    |
| Custom Language   | N/A    |    |

- **Original Language** – download an original file from the device including all user interface texts in English. The file format is XML; see below.
- **Custom Language** – upload, download and/or remove user files including translations of the user interface texts.

### 3.2.4 Hardware

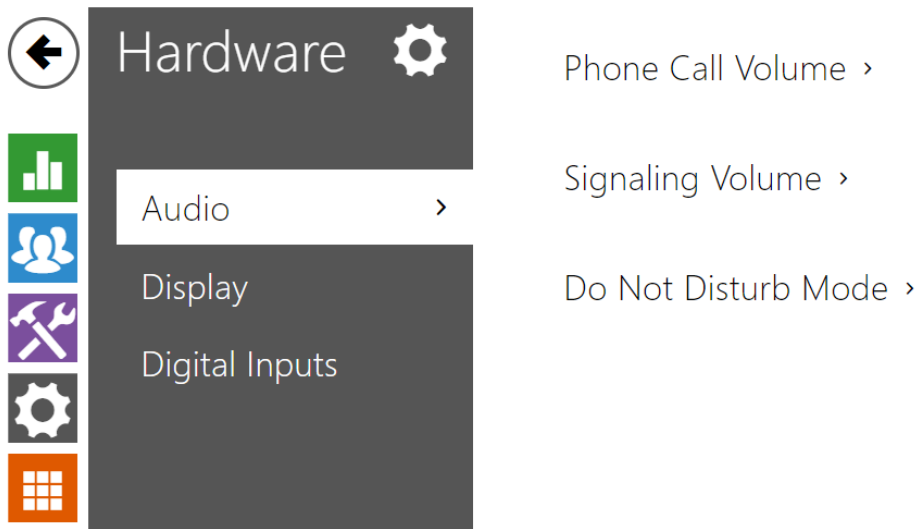

The **Audio** menu clearly displays the current audio information and features.

- [3.2.4.1 Audio](#)
- [3.2.4.2 Display](#)
- [3.2.4.3 Digital Inputs](#)



## 3.2.4.1 Audio

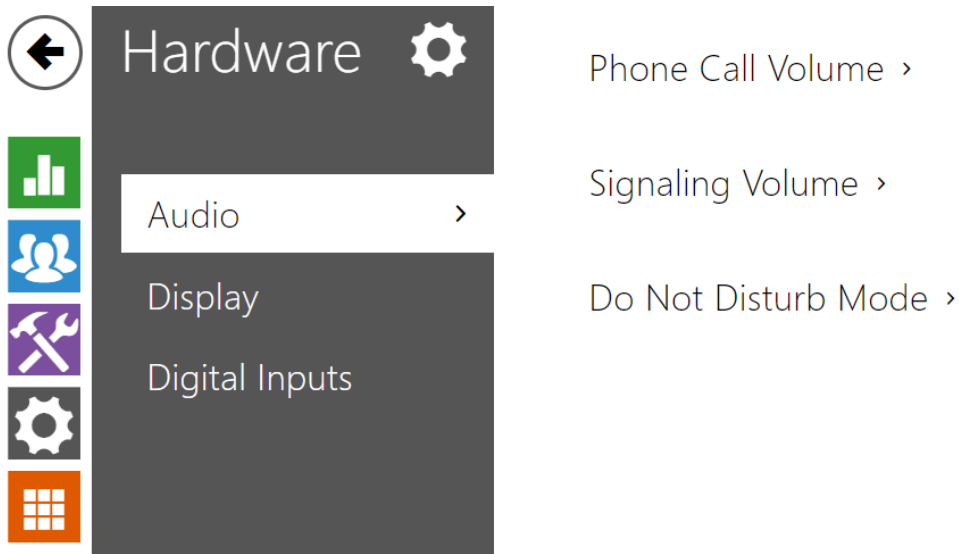

**2N® Indoor Compact** is equipped with a speaker. Set the phone call and state signaling volume control in this configuration section. **Master Volume** controls the general device volume including call volume, signaling tone volume, and so on. Consider the noise level of the ambient environment while setting this parameter.

## List of Parameters

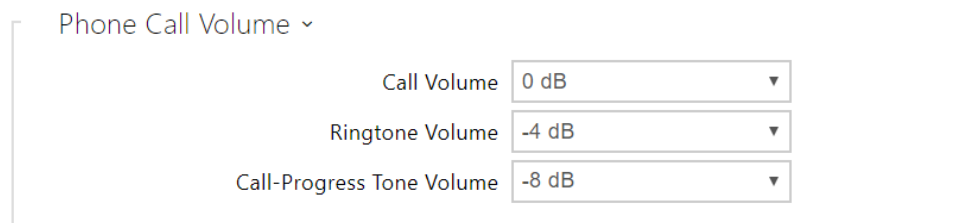

- **Call Volume** – set the phone call volume.
- **Ringtone Volume** – set the incoming call ringtone volume.
- **Call-Progress Tone Volume** – set the dialtone, ringtone and busy tone volume levels. In case the call progress tones are automatically generated by the PBX, this setting will not be applied.

Signaling Volume ▾

Key Beep Volume

Warning Tone Volume

Suppress Warning Tones

User Sounds Volume

- **Key Beep Volume** – set the key beep volume. The volume values are relative against the set master volume.
- **Warning Tone Volume** – set the volume of warning and signaling tones. The volume values are relative against the set master volume.
- **Suppress Warning Tones** – suppress signaling of the following operational states: Internal application started, IP address received and IP address lost.
- **User Sound Volume** – set the volume of the user sounds. The volume values are relative against the set master volume.

Do Not Disturb Mode ▾

DND Mode for Doorbell Button

Reject Calls

- **DND Mode for Doorbell Button** – if this function is activated, the device will not ring when the doorbell is pressed.
- **Reject Call** – if this function is activated, the device reject calls in the Do not Disturb mode. The function can be used for immediate call redirection at absence to a mobile phone call, for example.

## 3.2.4.2 Display

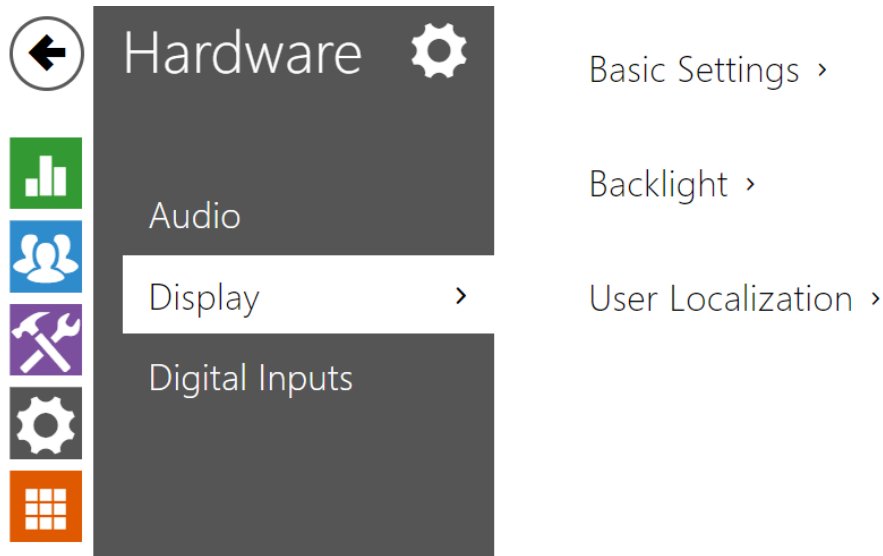

Set the basic display parameters on this tab.

Basic Settings ▾

|                           |                                     |
|---------------------------|-------------------------------------|
| Language                  | Česky ▾                             |
| Date Format               | 31/12/2018 ▾                        |
| Time Format               | 22:30 ▾                             |
| Enable Screen Lock        | <input type="checkbox"/>            |
| Screen Lock PIN           | ....                                |
| Display Setting Menu      | <input checked="" type="checkbox"/> |
| Display Time in Idle Mode | <input checked="" type="checkbox"/> |

- **Language** – set the language for the texts to be displayed. Choose one of the seven pre-defined languages (CZ, EN, DE, FR, ES, IT, RU).
- **Date Format** – set the date format to be displayed.
- **Time Format** – set the time format to be displayed.
- **Enable Screen Lock** – activate the screen lock function.
- **Screen Lock PIN** – set the screen lock activation/deactivation code.
- **Display Setting Menu** – display the Setting menu.
- **Display Time in Idle Mode** – switch off the device display and all backlight in the idle mode.

Backlight ▾

Intensity in Active Mode 100 % ▾

Decrease Intensity in Idle Mode to 1/3 ▾

Go to Idle Mode in 10 min ▾

Backlit Buttons in Idle Mode

- **Intensity in Active Mode** – set the display and button backlight intensity values. Set the value as a percentage of the maximum possible LED brightness.
- **Decrease Intensity in Idle Mode to** – backlight intensity decrease when the device has switched to the idle mode.
- **Go to Idle Mode in** – inactivity timeout after which the device switches to the idle mode.
- **Backlit Buttons in Idle Mode** – enable button backlight in idle mode if checked.

User Localization ▾

FILE

Original Language 

- **Original Language** – download the localization file template for own translation. It is an XML file with all the texts to be displayed.

**Note**

If none of the pre-defined languages is convenient for you, proceed as follows:

- Download the original language file (English).
- Modify the file using a text editor (replace the English texts with your own ones).
- Upload the modified localization file back to the intercom.
- Set **Language Settings | Language to Custom**.
- Check and correct if necessary the texts on the intercom display.

### 3.2.4.3 Digital Inputs

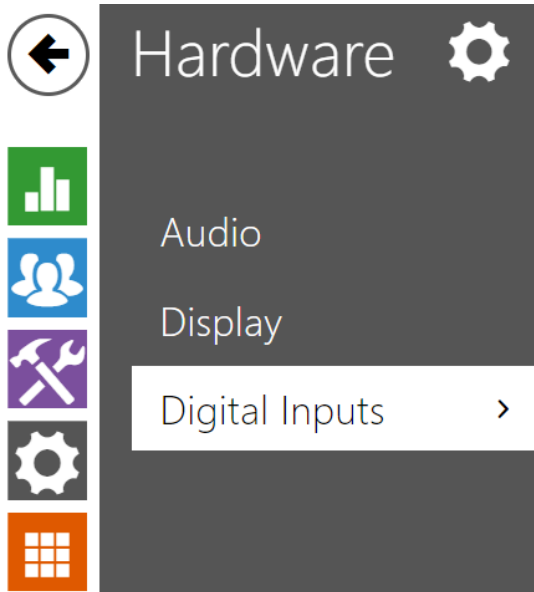

Doorbell button >

This subsection describes the digital input options of the device.

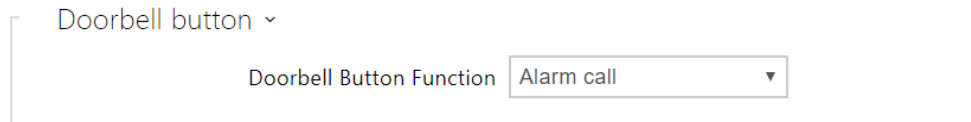

- **Doorbell Button Function** – select doorbell function (doorbell, alarm call). The button is used either as a classical doorbell or for alarm call activation.

### 3.2.5 System

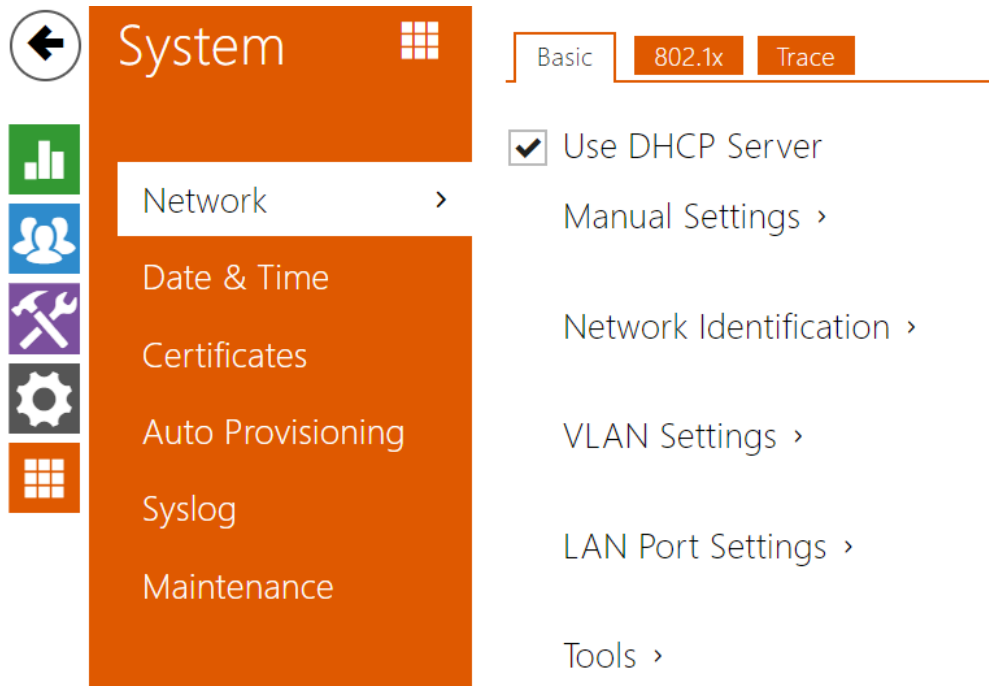

Here is what you can find in this section:

- [3.2.5.1 Network](#)
- [3.2.5.2 Date and Time](#)
- [3.2.5.3 Certificates](#)
- [3.2.5.4 Auto Provisioning](#)
- [3.2.5.5 Syslog](#)
- [3.2.5.6 Maintenance](#)

## 3.2.5.1 Network

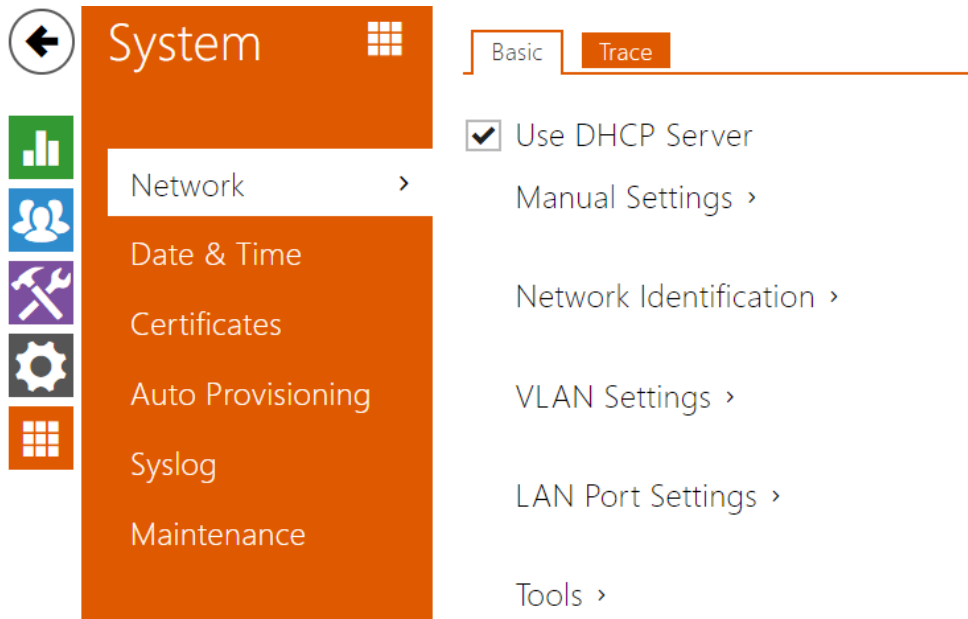

To be connected to the LAN properly, **2N® Indoor Compact** has to be assigned a valid IP address or obtain the IP address from the LAN DHCP server. The Network section helps you configure the IP address and DHCP.

✓ **Tip**

- To look up the current **2N® Indoor Compact** IP address, apply the **2N® Network Scanner**, which can be downloaded freely from [www.2n.com](http://www.2n.com), and use the mechanism described in [2.4 2N® Indoor Compact LAN Location via 2N® Network Scanner](#).

## List of Parameters

## Basic

Use DHCP Server

- **Use DHCP server** – enable automatic obtaining of the IP address from the LAN DHCP server. If the DHCP server is unavailable or otherwise inaccessible in your LAN, use the manual network settings.

Manual Settings ▾

|                   |  |
|-------------------|--|
| Static IP Address | <input type="text" value="192.168.1.100"/> |
| Network Mask      | <input type="text" value="255.255.255.0"/> |
| Default Gateway   | <input type="text" value="192.168.1.1"/>   |
| Primary DNS       | <input type="text"/>                       |
| Secondary DNS     | <input type="text"/>                       |

- **Static IP Address** – static IP address of the device. The address is used together with the parameters below unless Use DHCP server is enabled.
- **Network Mask** – network mask setting.
- **Default Gateway** – default gateway address for off-LAN communication.
- **Primary DNS** – primary DNS address for domain name-to-IP address translation.
- **Secondary DNS** – secondary DNS address where the primary DNS is unavailable.

Network Identification ▾

|                         |   |
|-------------------------|---|
| Hostname                | <input type="text" value="2NIndoorCompact-522339"/> |
| Vendor Class Identifier | <input type="text"/>                                |

- **Hostname** – set the device LAN identification.
- **Vendor Class Identifier** – set the manufacturer identifier as a character string for DHCP Option 60.



## VLAN Settings ▾

VLAN Enabled

VLAN ID

- **VLAN Enabled** – enable the virtual network support (VLAN according to 802.1q). Remember to set the VLAN ID too.
- **VLAN ID** – choose a VLAN ID from the range of 1–4094. The device shall only receive packets with the set ID. An incorrect setting may result in a connection loss and subsequent factory reset.

## LAN Port Settings ▾

Required Port Mode

Current Port State **Full Duplex – 100mbps**

- **Required Port Mode** – set the LAN port mode to be preferred: Automatic or Half Duplex – 10 Mbps. The bit rate is reduced to 10 Mbps in case the available LAN cabling is unreliable for a 100 Mbps traffic.
- **Current Port State** – current LAN port state: Half or Full Duplex – 10 Mbps or 100 Mbps.

## Tools ▾

Verify network address accessibility

- **Verify the network address accessibility** – check the accessibility of a given address in the LAN via the Ping command like in common operating systems. Press Ping to display a dialogue for you to enter the IP address/domain name and press Ping to send the test data to the set address. If the IP address/domain name is invalid, a warning is displayed and the Ping button remains inactive until the IP address becomes valid. The dialogue also displays the procedure state and result. Failed means that either the IP address was unavailable within 10 s or it was impossible to translate the domain name into an address. If a valid response is received, the response sending IP address and response waiting time in milliseconds are displayed. Press Ping again to send another query to the same address.

## 801.1x

Device Identity ▾

Device Identity

- **Device Identity** – username (identity) for authentication via EAP-MD5 and EAP-TLS.

MD5 Authentication ▾

MD5 Authentication Enabled

Password

- **MD5 Authentication Enabled** – enable authentication of network devices via the 802.1x EAP-MD5 protocol. Do not enable this function if your LAN does not support 802.1x. If you do so, the intercom will become inaccessible.
- **Password** – enter the access password for EAP-MD5 authentication.

TLS Authentication ▾

TLS Authentication Enabled

Trusted Certificate

User Certificate

- **TLS Authentication Enabled** – enable authentication of network devices via the 802.1x EAP-TLS protocol. Do not enable this function if your LAN does not support 802.1x. If you do so, the intercom will become inaccessible.
- **Trusted Certificate** – specify the set of trusted certificates for verification of the RADIUS server public certificate validity. Choose one of three sets of certificates; refer to the Certificates subsection. If no trusted certificate is included, the RADIUS public certificate is not verified.
- **User Certificate** – specify the user certificate and private key for verification of the intercom authorisation to communicate via the 802.1x-secured network element port in

the LAN. Choose one of three sets of user certificates and private keys; refer to the Certificates subsection.

**Note**

- *This function is available with the Gold or Enhanced Security license only.*

## PEAP MSCHAPv2 authentication ▾



Authentication Allowed

Trusted Certificate

Password

- **Authentication Allowed** – enable authentication of network devices via the 802.1x PEAP MSCHAPv2 protocol. Do not enable this function if your LAN does not support 802.1x. If you do so, the device will become inaccessible.
- **Trusted Certificate** – specify the set of trusted certificates for verification of the RADIUS server public certificate validity. Choose one of three certificate sets, see the Certificates subsection. If no trusted certificate is included, the RADIUS public certificate is not verified.
- **Password** – enter the access password for PEAP-MSCHAPv2 authentication.

## Trace

The Trace tab helps you trigger capturing of incoming and outgoing packets via the **2N® Indoor Compact** LAN interface. The captured packets are stored in a 4 MB buffer. When the buffer storage capacity is full, the oldest packets are rewritten automatically. You are recommended to keep the video stream bit rate below 512 kbps while capturing packets. Press  to start capturing,  to stop capturing and  to download the captured packet file.



## Packet Capture Status ▾

Current State **RUNNING**

Buffer Size **4 MB**

Buffer Utilization **797 kB**

Number of Captured Packets **2240**

Packet Capture Control   

### 3.2.5.2 Date and Time

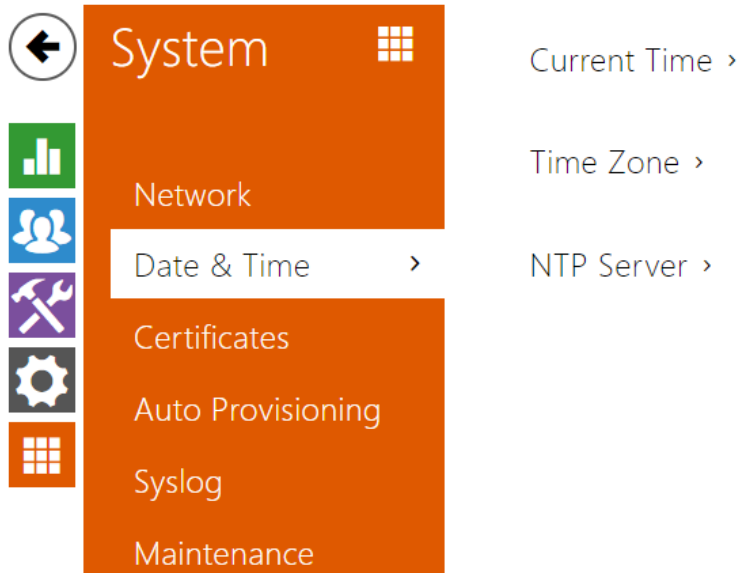

**2N® Indoor Compact** is equipped with a real time clock to back up the device for even a few days in case of power outage. Click **Synchronize** to synchronize **2N® Indoor Compact** with your PC time value any time.

Time in **2N® Indoor Compact** can be synchronized with any available SNTP server.

**Note**

- *A correct date/time value is unnecessary for the basic function of **2N® Indoor Compact**, but crucial for a proper function of time profiles and correct event times in variable lists (Syslog, Entered cards, Logs downloaded via **HTTP API**, etc.).*

In standard operational conditions, the **2N® Indoor Compact** real time circuit accuracy is  $\pm 0.005\%$ , which may represent an error of up to  $\pm 2$  minutes per month.

## List of Parameters

Current Time ▾

Current Device Time **03/21/2019 10:23:59**

**Synchronize with browser**

- **Synchronize with browser** – click the button to synchronize the device time with your current PC time value.

Time Zone ▾

Automatic Detection

Detected Time Zone **N/A**

Manual Selection

Custom Rule

- **Automatic Detection** – define whether the time zone shall be detected automatically from My2N. In case automatic detection is disabled, the Manual selection parameter is Used (manually selected time zone or Own rule).
- **Detected Time Zone** – display the automatically found time zone. In case the function is unavailable or disabled, N/A is displayed.
- **Manual Selection** – set the installation site time zone. Set the time shift and summer/winter time transitions.
- **Custom Rule** – if the device is installed on a site that it not included in the Time Zone parameter, set the time zone rule manually. The rule is applied only if the Time Zone parameter is set to Manual.

NTP Server ▾

Use NTP Server

NTP Server Address

NTP Time Status **Synchronized**

- **Use NTP Server** – enable the use of the NTP server for internal time Synchronization.
- **NTP Server Address** – set the IP address/domain name of the NTP server used for the device internal time synchronization.
- **NTP Time Status** – display the state of the last local time synchronization attempt via NTP: Unsynchronized, Synchronized, Error.

### 3.2.5.3 Certificates

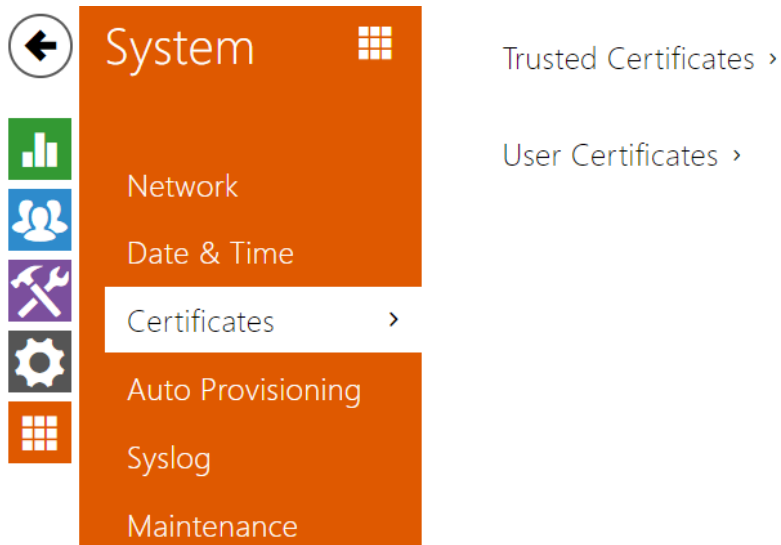

Some **2N® Indoor Compact** LAN services use the secure TLS protocol for communication with the other LAN devices. This protocol prevents third parties from eavesdropping on or modifying call contents. TLS is based on one/two-sided authentication, which requires certificates and private keys.

**2N® Indoor Compact** services that use TLS:

- a. Web server (HTTPS)
- b. E-mail (SMTP)
- c. 802.1x (EAP-TLS)
- d. SIPs

**2N® Indoor Compact** allows you to download up to 3 sets of certificates issued by certification authorities, which help you authenticate the communicating device, and also 3 user certificates and private keys for encryption purposes.

Each certificate requiring service can be assigned one certificate set, refer to the **Web Server**, **E-mail** and **Streaming** subsections. The certificates can be shared by multiple services.

**2N® Indoor Compact** accepts the DER (ASN1) and PEM certificates.

Once powered up, **2N® Indoor Compact** generates automatically the so-called **Self Signed certificate** and a **private key**, which can be used for the **Web server** and **E-mail** services without the need to upload a unique certificate and private key.



**Note**

- If you use the Self Signed certificate for encryption, the **2N® Indoor Compact** web server - browser communication is secure, but the browser notifies you that it cannot authenticate the **2N® Indoor Compact** certificate.

Refer to the tables below for the current list of trusted and user certificates:

| Trusted Certificates ▾ |        |          |
|------------------------|--------|----------|
| CA IDENTITY            | ISSUER | VALID TO |
| (1)                    |        |          |
| (2)                    |        |          |
| (3)                    |        |          |

| User Certificates ▾ |        |             |
|---------------------|--------|-------------|
| CA IDENTITY         | ISSUER | EXPIRY TIME |
| (1)                 |        |             |
| (2)                 |        |             |
| (3)                 |        |             |

Click  to upload a certificate saved on your PC. Select the certificate (or private key) file in a dialogue window and click **Upload**. Press  to remove a certificate from **2N® Indoor Compact**.



 **Caution**

- Note that a certificate with a private RSA key longer than 2048 bits may be rejected and the following message will be displayed:  
**The private key file/password was not accepted by the device!**
- For certificates based on elliptic curves use the secp256r1 (aka prime256v1 aka NIST P-256) and secp384r1 (aka NIST P-384) curves only.

### 3.2.5.4 Auto Provisioning

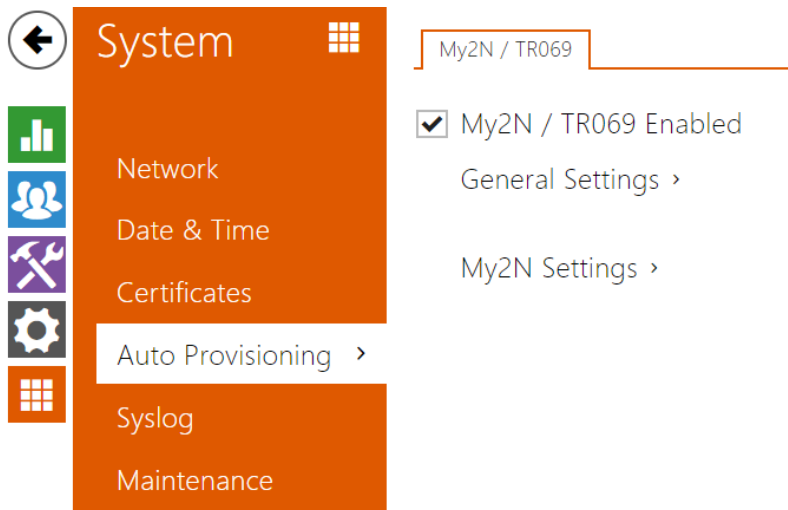

**2N® Indoor Compact** helps you update firmware and configuration manually or automatically from a selected TFTP/HTTP server storage according to predefined rules.

The TFTP and HTTP server addresses can be configured manually. **2N® Indoor Compact** supports automatic address identification via the local DHCP server (Option 66).

#### My2N / TR069

Use this tab to enable and configure remote device management via the TR-069 protocol. TR-069 helps you reliably configure the device parameters, update and back up configuration and/or upgrade device firmware.

The TR-069 protocol is utilized by the My2N cloud service. Make sure that TR-069 is enabled and Active profile set to My2N to make the device work with My2N properly. Only then the device will be able to log in to My2N periodically for configuration.

This function helps you connect the device to your ACS (Auto Configuration Server). In this case, the connection to My2N will be disabled in the device.

My2N / TR069 Enabled

- **My2N / TR069 Enabled** – enable connection to My2N or another ACS server.

## General Settings ▾

Active Profile

Next synchronization in **9h 47m 48s**

Connection State **Synchronized**

Communication Status Detail **HTTP status: 204, No Content.**

- **Active Profile** – select one of the pre-defined profiles (ACS), or choose a setting of your own and configure the ACS connection manually.
- **Next synchronization in** – display the time period in which the device shall contact a remote ACS.
- **Connection Status** – display the current ACS connection state or error state description if necessary.
- **Communication Status Detail** – server communication error code or HTTP status code.
- **Connection test** – test the TR069 connection according to the set profile, see the Active profile. The test result is displayed in the Connection status.

## My2N Settings ▾

My2N ID

My2N Security Code **HXGW-6EQT-M6JM-ANL5**

- **My2N ID** – unique identifier of the company created via the My2N portal.
- **My2N Security Code** – device code for adding to My2N.

## 3.2.5.5 Syslog

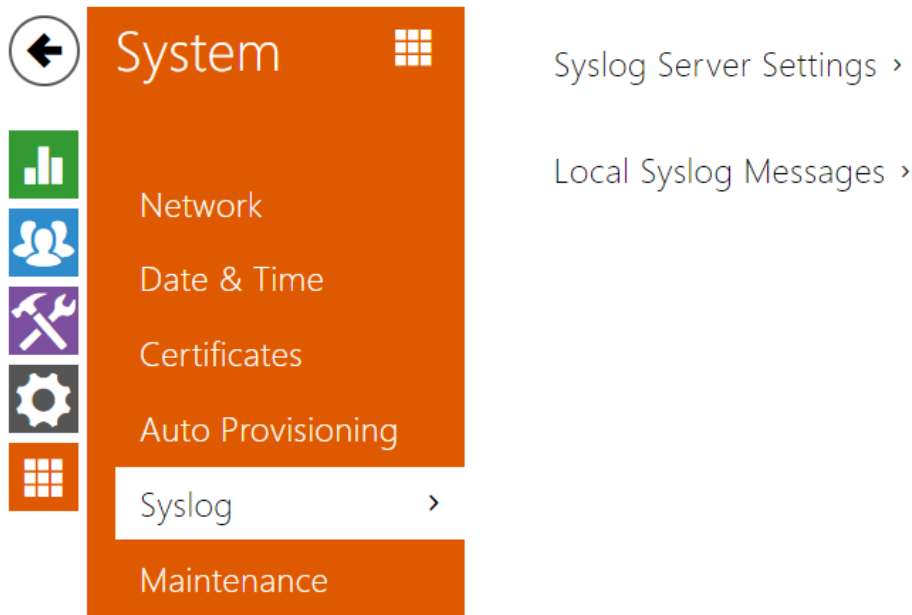

**2N® Indoor Compact** allows you to send syslog messages including relevant device state and process information to a syslog server for recording and further analysis or auditing of the device observed. It is unnecessary to configure this service for common operations.

## List of Parameters

Syslog Server Settings ▾

Send Syslog Messages

Server Address

Severity Level

- **Send Syslog Messages** – enable sending of syslog messages to the Syslog server. Make sure that the server address is valid.
- **Server Address** – IP/MAC address of the server on which the syslog recording application is running.
- **Severity Level** – set the severity level of the messages to be sent. Debug 1–3 level setting is only recommended to facilitate troubleshooting for the Technical Support department.

Local Syslog Messages ▾

Saving Syslog Messages **RUNNING**

Syslog Messages Saving Passed Time **0h 4m 26s**





Syslog Messages Saving Remaining Time **0h 55m 34s**

Saved Syslog Messages Size **78,335 B**

Available Syslog Messages Saving Time **0h 4m 26s**

Available Syslog Messages Size **78,335 B**

Required Saving Time

Syslog Messages Saving Control    

General overview of local syslog messages.

## 3.2.5.6 Maintenance

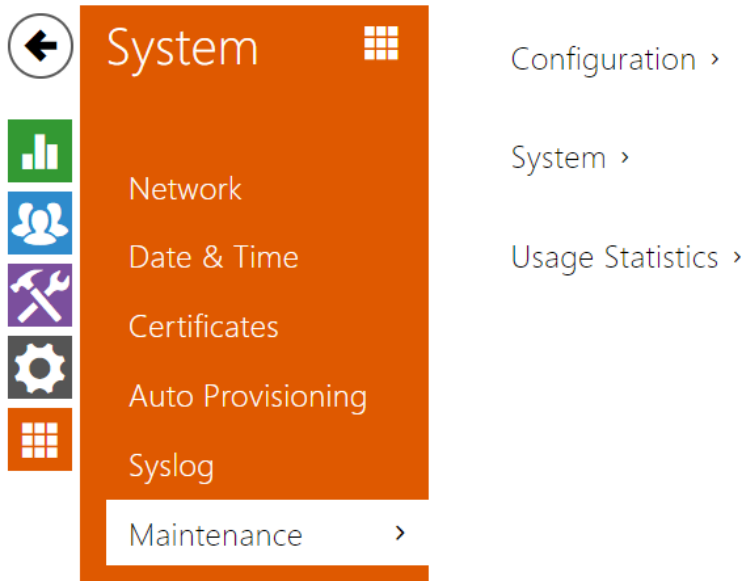

This menu helps you maintain the device configuration and firmware. You can back up and restore all the parameters, upgrade firmware and/or factory reset the device.

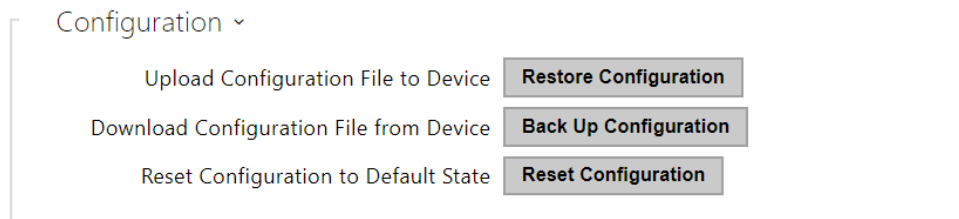

- **Restore Configuration** – restore configuration from a previous backup. Press the button to display a dialogue window to select a configuration file and upload it to the device. Before uploading choose whether or not the LAN settings and SIP PBX connection settings are to be applied.
- **Backup Configuration** – back up the complete current device configuration. Press the button to download the configuration file to your PC.

**⚠ Caution**

- *As the configuration may include delicate information, such as user phone numbers and access passwords, handle the file cautiously.*

- **Reset Configuration** – reset all the device parameters except for the LAN parameters. To reset the device completely, use the jumper or press Reset.

System ▾

Firmware Version **2.27.0.36.0**

Bootloader Version **1.0.0.0.4**

Software Build Type **alpha\_997f608597fcfe...**

Software Build Date and Time **3/19/2019 13:48:23 PM**

Upgrade Device Firmware **Upgrade Firmware**

Firmware Status **Server error**

**Check Now**

Notify of Beta Versions

Restart Device **Restart Device**

Licenses **Show**

- **Upgrade Device Firmware** – upload a new firmware version to the device. Press the button to display a dialogue window to select the proper firmware file. Once the firmware is uploaded, the device is restarted automatically and becomes fully operational with a new firmware version. The whole upgrading process takes less than one minute. Download the current firmware version for your device from [www.2n.com](http://www.2n.com). Firmware upgrade does not affect configuration. The device checks the firmware file and prevents you from uploading an incorrect or corrupt file.
- **Firmware Status** – check online if a later firmware version is available. If so, the downloading option is offered followed by automatic upgrade.
- **Notify of Beta Versions** – enable monitoring and downloading of the latest firmware beta version.
- **Restart Device** – restart the device. The process takes about 30 s. Once restart is completed and the device is assigned its IP address, the login window will be displayed automatically.
- **Licenses** – click Show to open a dialogue window including a list of used licenses and third-party libraries. It also includes a EULA link.

Usage Statistics ▾

Send anonymous statistics data

- **Send anonymous statistics data** – enable sending of anonymous statistic data on device usage to the manufacturer. No such delicate information as passwords, access codes or phone numbers are included. This information helps 2N TELEKOMUNIKACE a.s. improve

the software quality, reliability and performance. You can participate in this voluntarily and cancel your statistic data deliveries any time.



## 4. Device Control via Display

The backlit MENU buttons to the right and left help you control the device using the display. The MENU buttons are used for shifting and confirming functions in the selected display menu. In general, the MENU buttons to the right shift items up and down in the selected menu. The left-hand lower button confirms your selection and the left-hand upper button goes back by one step with every press or returns to the home page.





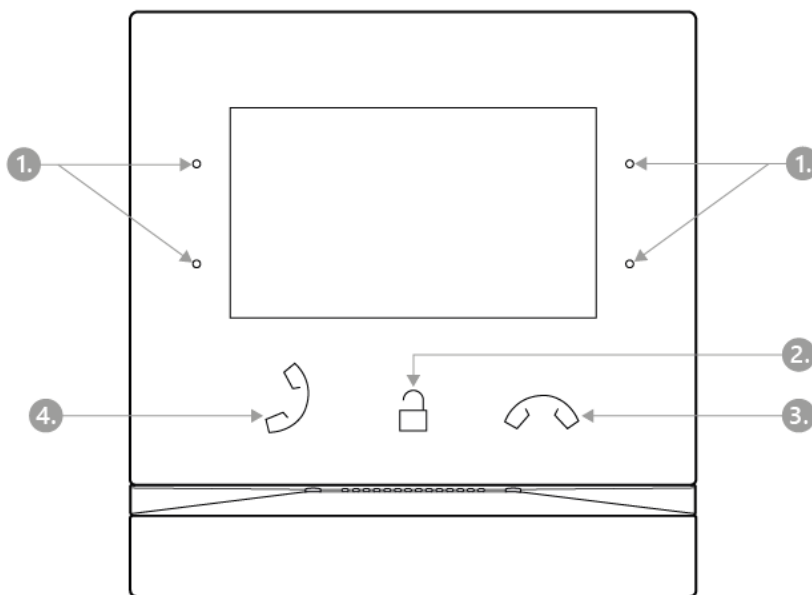







Refer to the following subsections for more configuration details.







- [4.1 Directory](#)
- [4.2 Call Log](#)
- [4.3 Do Not Disturb Mode](#)
- [4.4 Settings](#)



1. MENU buttons
2. Lock button
3. Call end button
4. Call receiving button

### Icons used on the display

| Icon  | Description                                 |
|---|---|
|    | Directory                                   |
|    | DND mode                                    |
|    | Device configuration                        |
|    | Call log                                    |
|    | Incoming call ringtone volume up            |
|    | Incoming call ringtone volume down          |
|  | Incoming call ringtone volume mute          |
| +   | Value up                                    |
| —   | Value down                                  |
|  | Microphone mute in call                     |
|  | Locked, screen lock                         |
|  | Unlocked, screen lock activated/deactivated |
|  | Return to Home page                         |
|  | Confirmation                                |
|  | Device detail in Directory                  |

| Icon  | Description |
|---|-------------|
|  | Call info   |
|  | Camera 1    |
|  | Camera 2    |
|  | Back        |
|  | Move up     |
|  | Move down   |

## 4.1 Directory

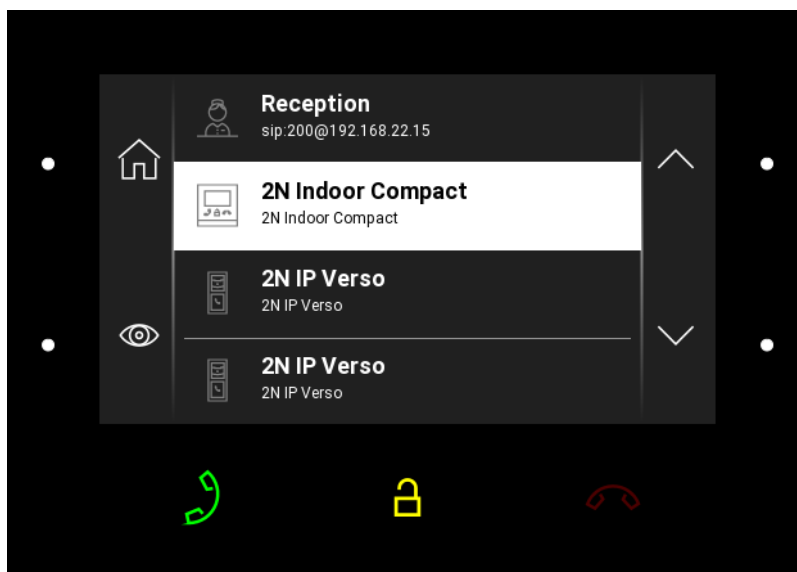





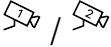

Press the left-hand upper button at the icon  to display the Directory list. The menu provides a list of destinations that can be called. The destinations include their names and the device type they are equipped with. The destinations that allow for some actions (calls) are white-highlighted. The other destinations are gray.

Use the backlit right-hand upper button and lower MENU button to move across the Directory. Press the left-hand bottom button at the  icon to show the camera preview if the device is equipped with a camera. The camera preview option is based on the **2N® Enhanced Video** license of the selected device. Together with the preview, if available, the device type, name and icon details are displayed.



Press the call receiving button to start a call to the selected device or user. Click the lock button to open the door during an incoming/outgoing call for the selected device.

When the intercom camera view is displayed on **2N® Indoor Compact** during the call, you can choose any of the following actions:

- **Switch camera** using the left-hand upper MENU button at the  icon.
- **Mute microphone in call** using the left-hand lower MENU button at the  icon.
- **Volume up** using the right-hand upper MENU button at the  icon.
- **Volume down** using the right-hand lower MENU button at the  icon.
- **Open door** using the door lock button .
- **End call** using the  call end button.

#### **Caution**



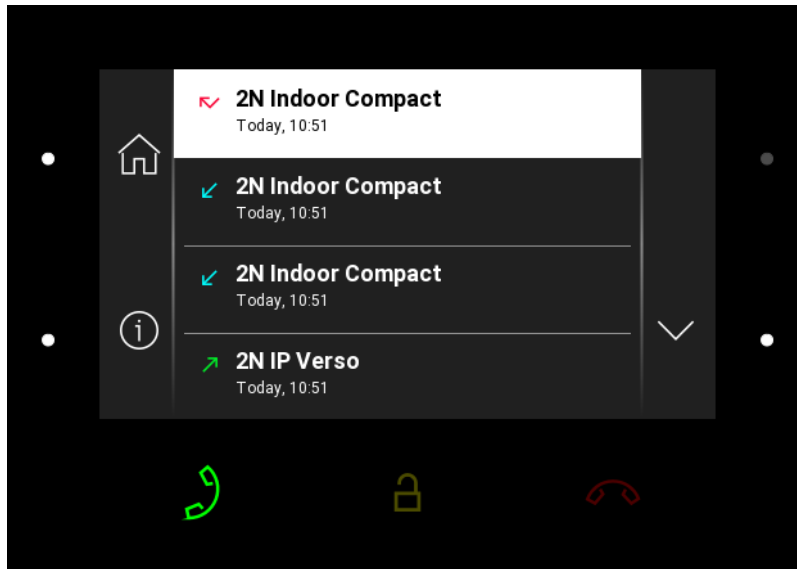

- The camera switching function is only displayed if it has been activated and properly configured in the intercom.

Set the Directory via the web interface in the Directory / Device section. You can add a device manually, by clicking on the device adding icon  or automatically by clicking the registered device searching icon . Select the device in the list to add it automatically to the Directory list. The values are completed in the basic settings. With manual addition of a device/user to the Directory, the basic parameters are not completed automatically but have to be added manually. Make sure to complete the proper parameter in the Display section to display the CLIP. This helps the user choose and call any device displayed; refer to [3.2.2 Directory](#) for more details.

## 4.2 Call Log



Press the left-hand lower button at the  icon to display the Call log. The menu provides a list of all accomplished calls including date, time, status (ougoing/incoming/missed) and information on from/to which destination the call was made. The destinations that allow for some actions are white-highlighted; the other ones are gray. The maximum call count is 20. You can choose any of the following actions from the **2N® Indoor Compact** call log:

- **Return to Home page** using the left-hand upper MENU button at the  icon.
- **Show detail** of the accomplished call using the left-hand lower MENU button at the  icon. This displays an image from a camera if available including the caller's ID and call time.
  - **Record deletion** – using the lower MENU button next to the icon .
- **Move up the list** using the upper MENU button at the  icon.
- **Move down the list** using the lower MENU button at the  icon.

### Caution

- The device restart results in a deletion of the call log.

### 4.3 Do Not Disturb Mode

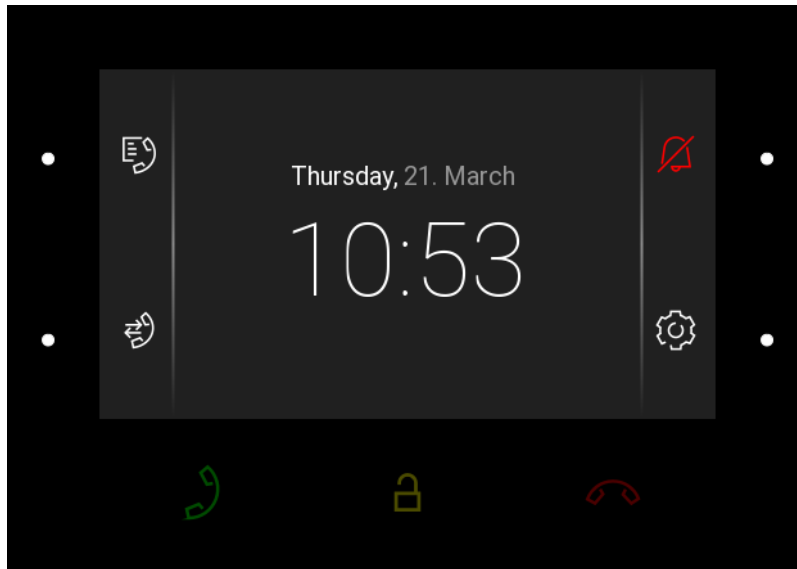

Press the right-hand upper MENU button at the  icon to activate/deactivate the DND mode. When DND is active, the device is at relax and the icon is red backlit. The device does not play the selected ringtone to signal an incoming call. The display shows the camera view if available, CLIP and Incoming call message.

### 4.4 Settings

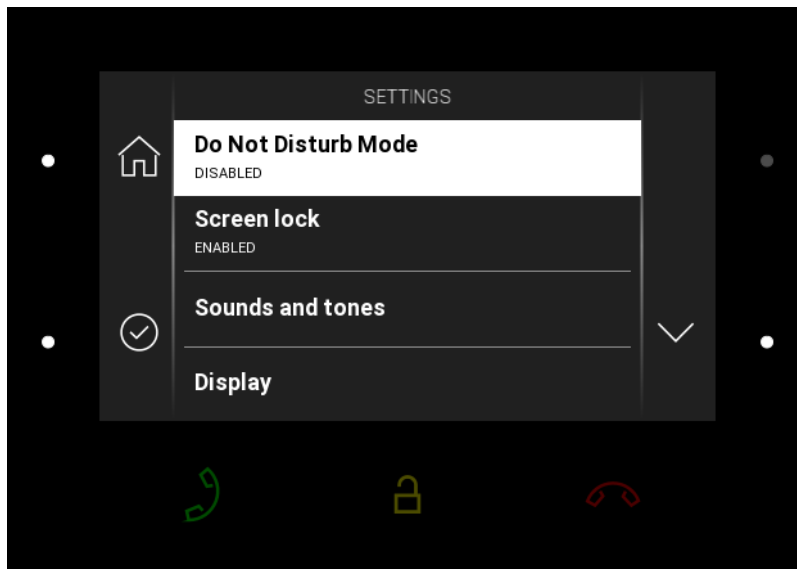

Press the right-hand lower button at the icon  to display the Device settings. Here set the DND mode, screen lock, device sounds and tones and display/system properties.

## Do Not Disturb Mode

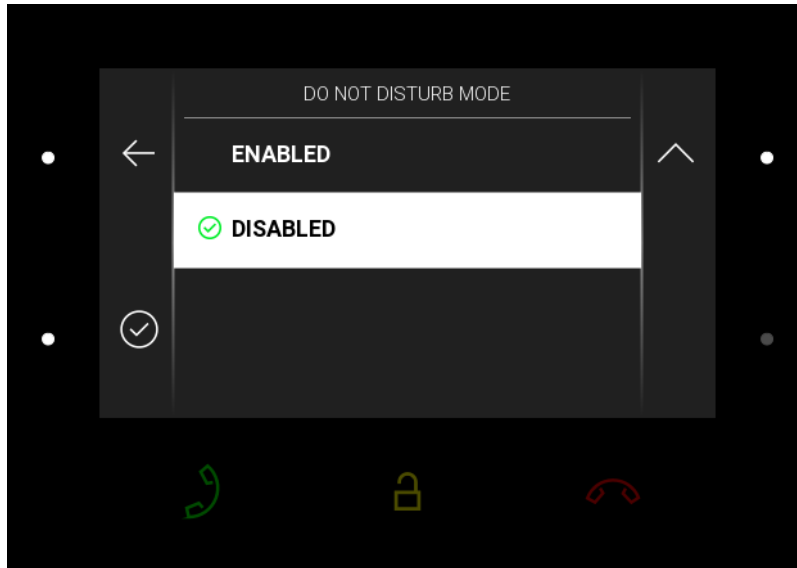

Enable/disable the DND mode using the left-hand lower button. With DND on, the icon  on the home page is red backlit. The device does not play the selected ringtone to signal an incoming call. The display shows the camera view if available, CLIP and Incoming call message.

## Screen Lock

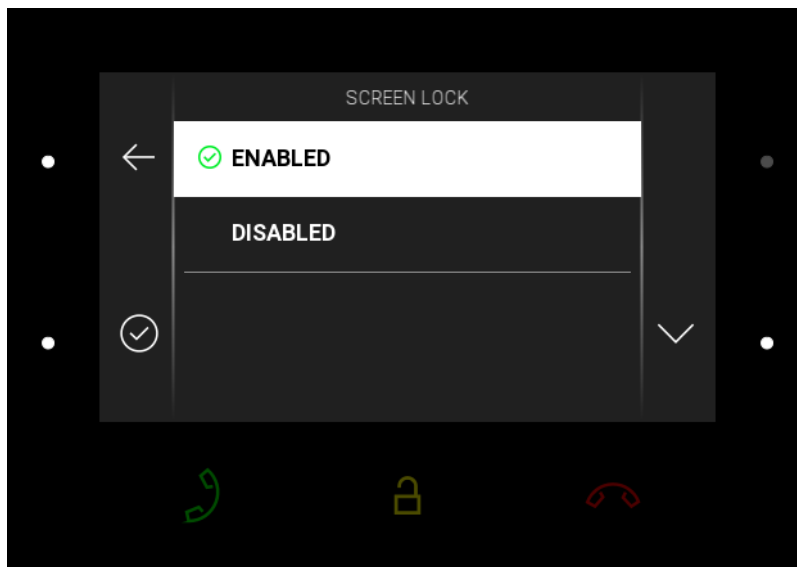

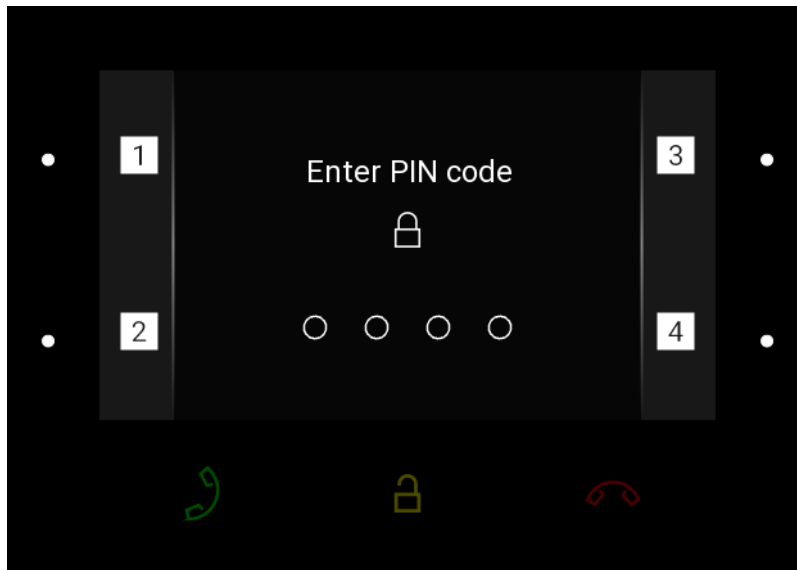

Enable/disable the screen lock (parental lock) using the left-hand lower button. Enter the PIN code to enable the screen lock. Enter the same PIN code to disable the screen lock.

## Sounds and Tones

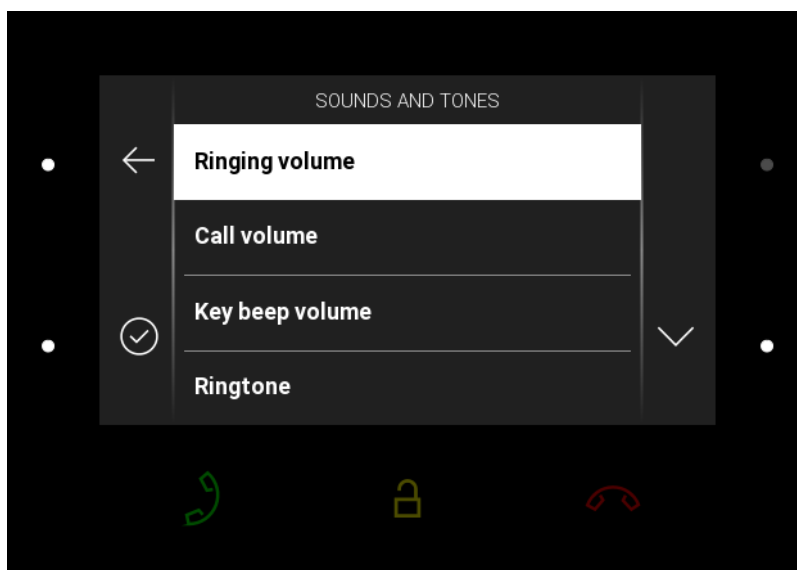

Press the right-hand lower button at the icon  to display the Sounds and Tones. Here set the ringing/call volume and select the ringtone and door bell ringtone.

### Ringtone volume



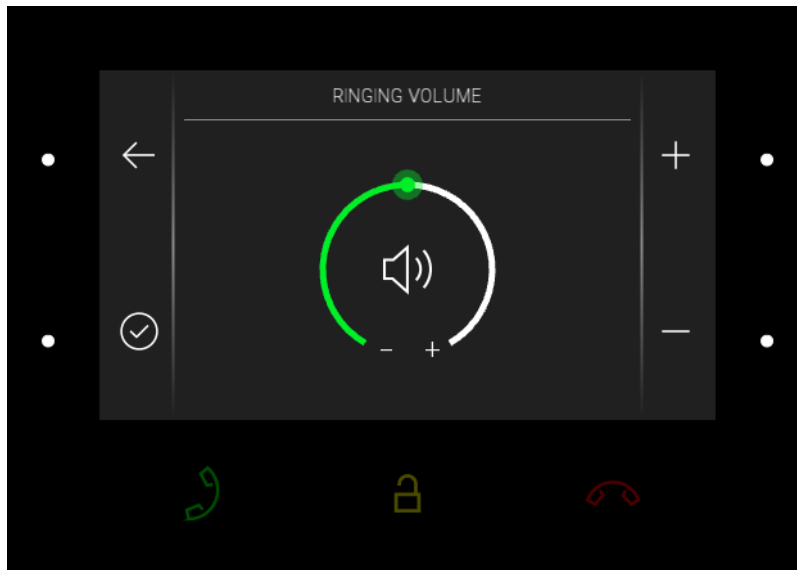

Press the right-hand upper/lower button to increase/decrease the ringing volume. Press the left-hand lower button to confirm the volume level selected. The change will not be saved unless confirmed.

#### **Call volume**

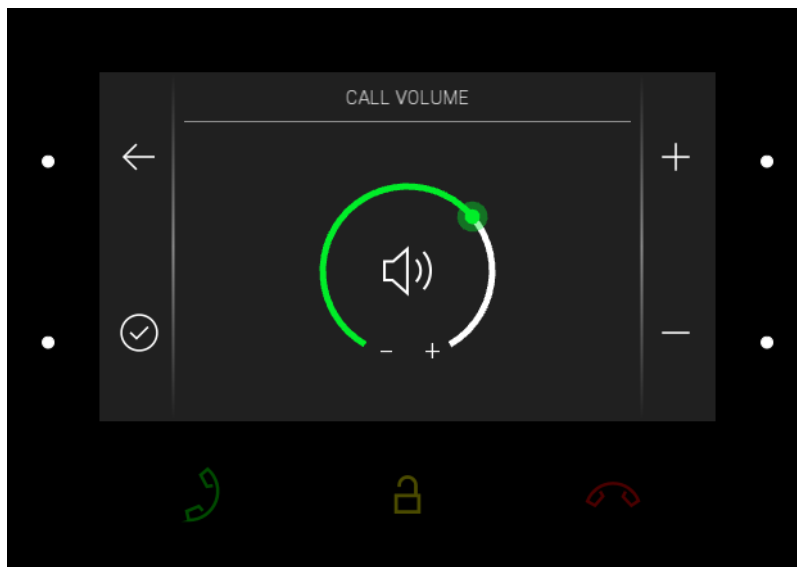

Press the right-hand upper/lower button to increase/decrease the call volume. Press the left-hand lower button to confirm the call volume level selected. The change will not be saved unless confirmed.

#### **Key Beep Volume**

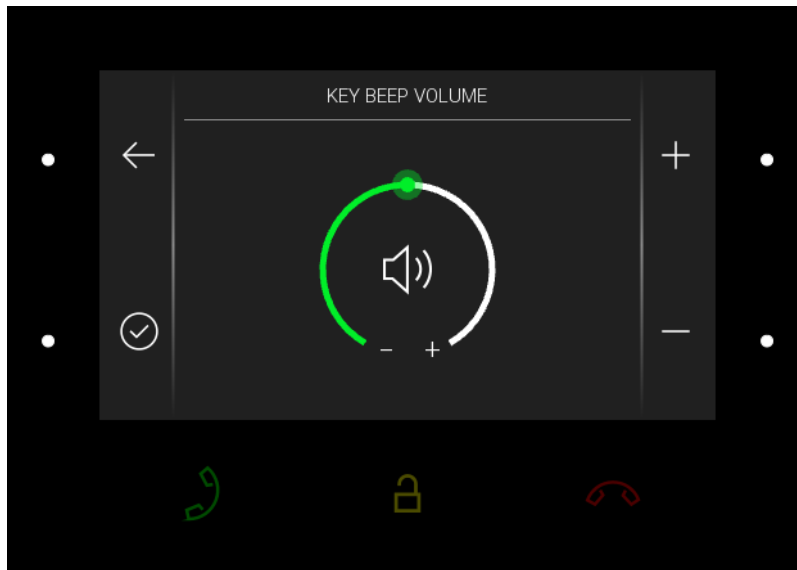

Press the right-hand upper/lower button to increase/decrease the key beep volume. Press the left-hand lower button to confirm the key beep volume level selected. The change will not be saved unless confirmed.

### **Ringtone**

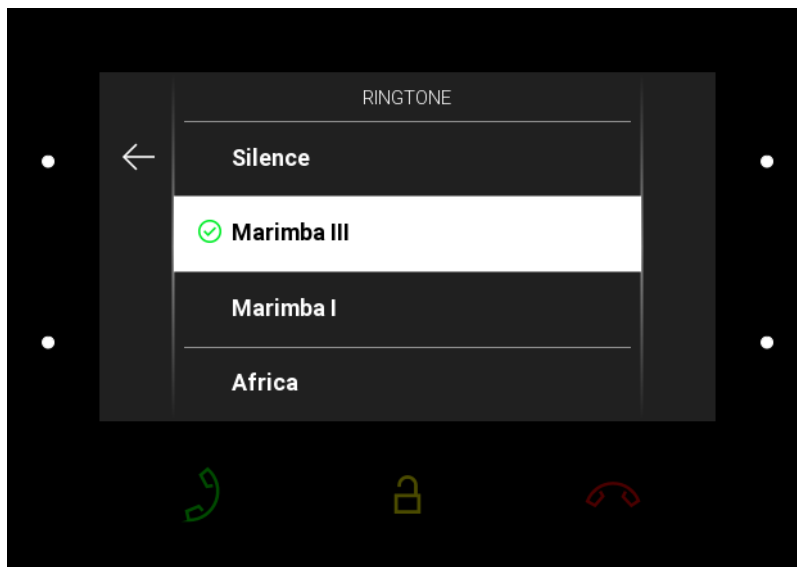

Press the right-hand upper/lower button to move up/down the ringtone list. Press the left-hand lower button to confirm the ringtone selected. The change will not be saved unless confirmed.

### **Doorbell ringtone**

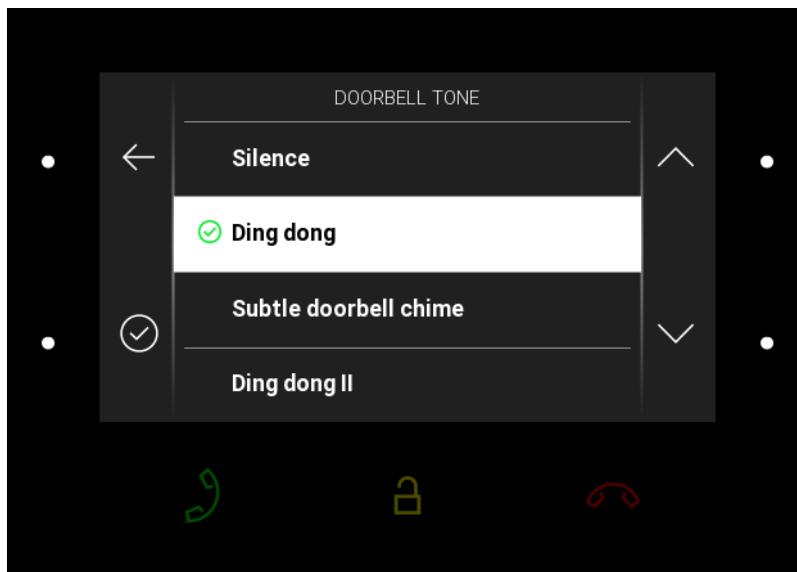

Press the right-hand upper/lower button to move up/down the doorbell ringtone list. Press the left-hand lower button to confirm the ringtone selected. The change will not be saved unless confirmed.

## Display

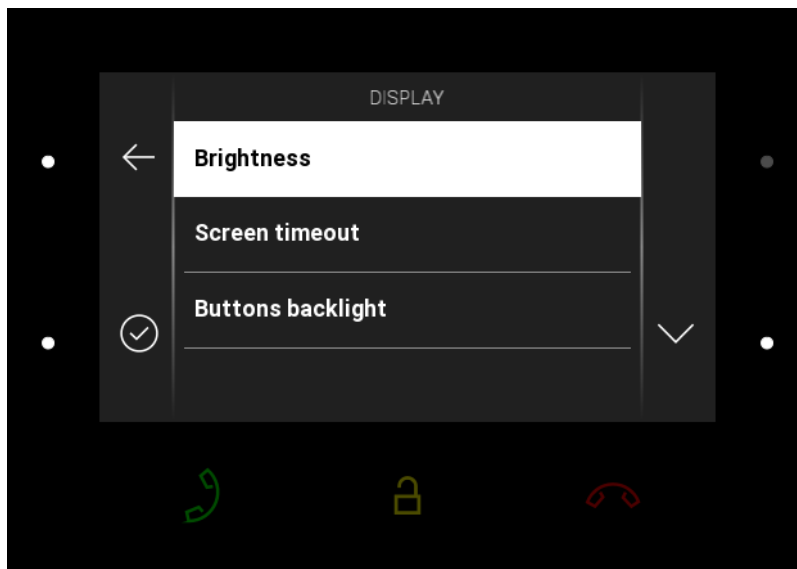
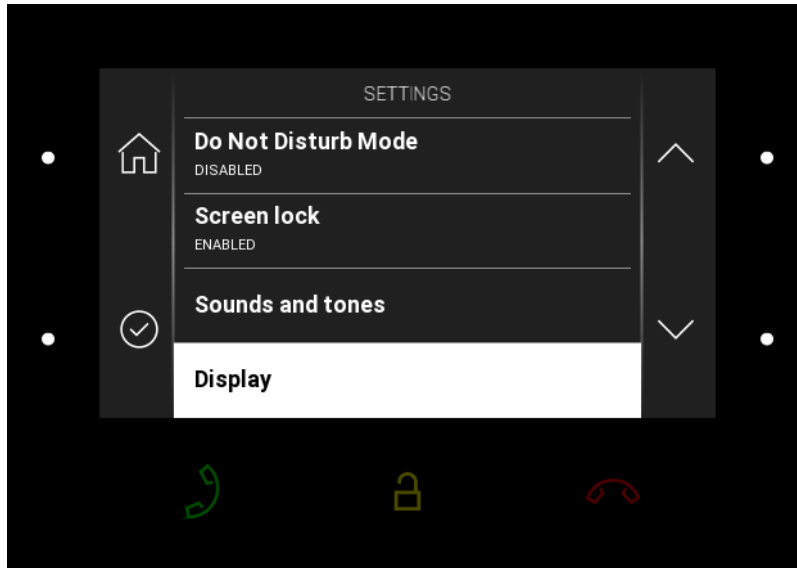

Press the right-hand lower button at the icon  to display the Display section. Here set the display brightness, idle timeout and button backlight.

## Brightness

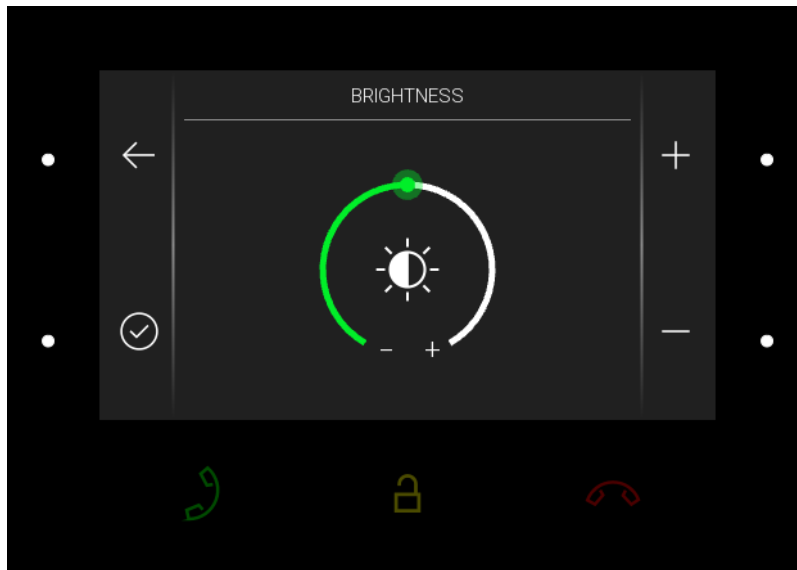

Press the right-hand upper/lower button to increase/decrease the display brightness. Press the left-hand lower button to confirm the brightness level selected. The change will not be saved unless confirmed.

## Screen timeout

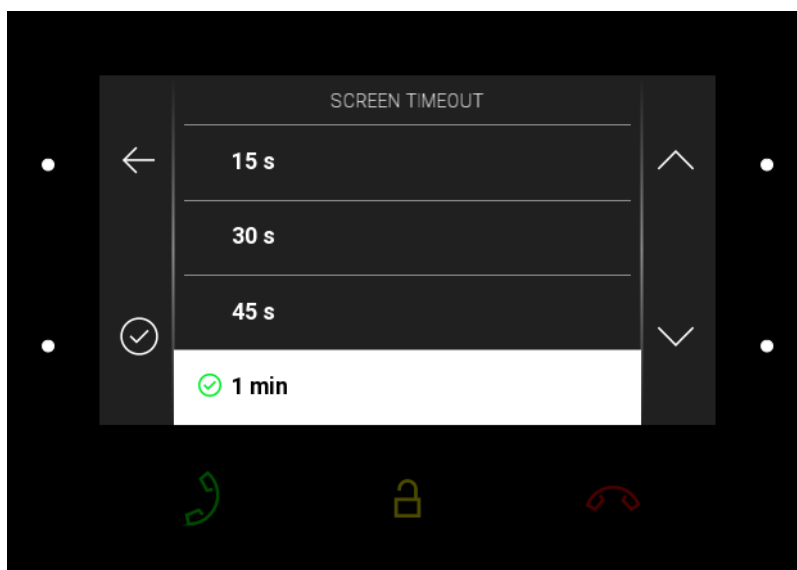

Set the maximum idle time (i.e. when the user does not control the device) after which the sleep mode is switched on automatically. Press the right-hand upper/lower button to move up/down the time value list. The change will not be saved unless confirmed.

## Button backlight

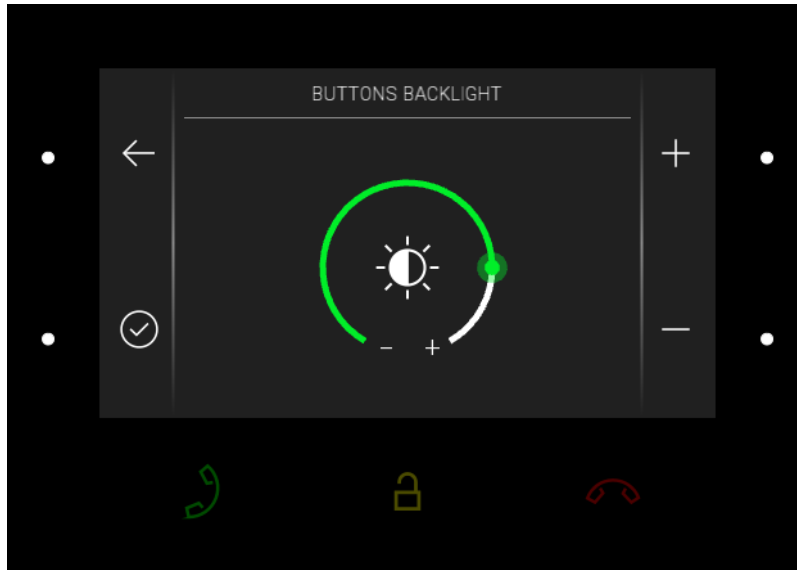

Press the right-hand upper/lower button to increase/decrease the button backlight. Press the left-hand lower button to confirm the backlight level selected. The change will not be saved unless confirmed.

## System

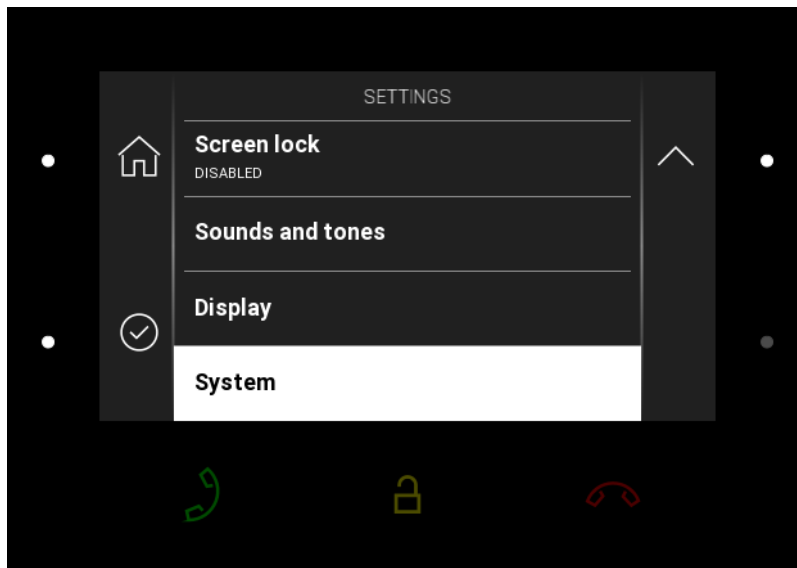

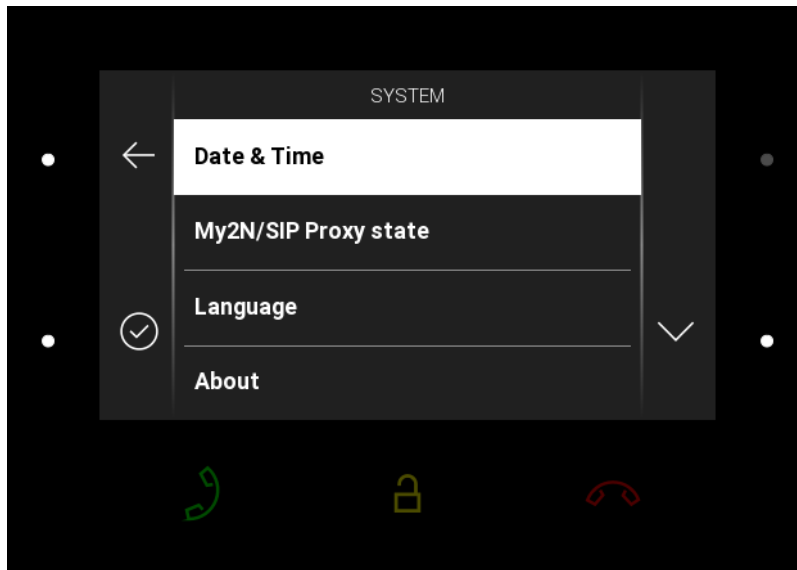

Press the right-hand lower button at the icon  to display the System section. Here set date and time, My2N/SIP Proxy state and language and get basic information on the device.

### Date and time

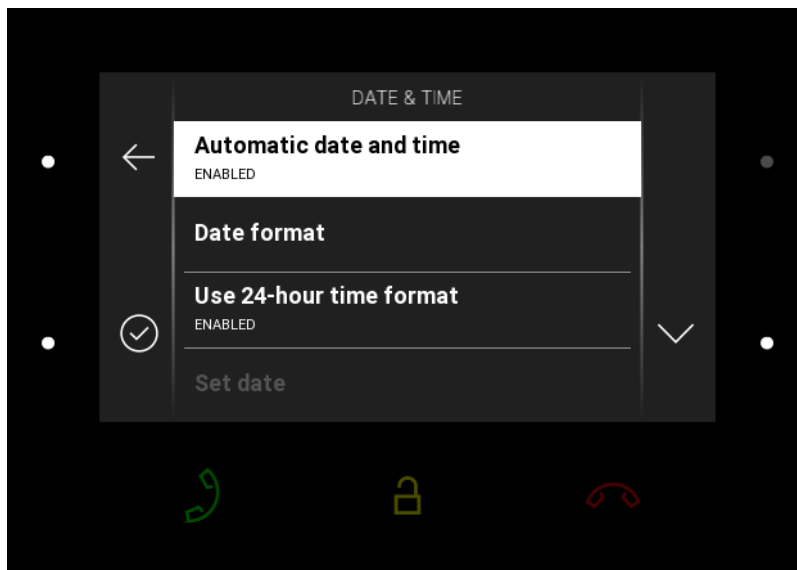

- **Automatic date and time** – enable the use of the NTP server for automatic internal time synchronization.
- **Date format** – there are 3 date format options: 12.31.2019, 31.12.2019, 2019.12.31.
- **Use 24-hour time format** – enable/disable the 24hour time format.
- **Set date** – set the date manually unless automatic date synchronization is enabled.
- **Time Zone** – set the time zone for your installation site to define time shifts and summer/winter time transitions.

**⚠ Caution**

- The change will not be saved unless confirmed.

**My2N/SIP Proxy State**

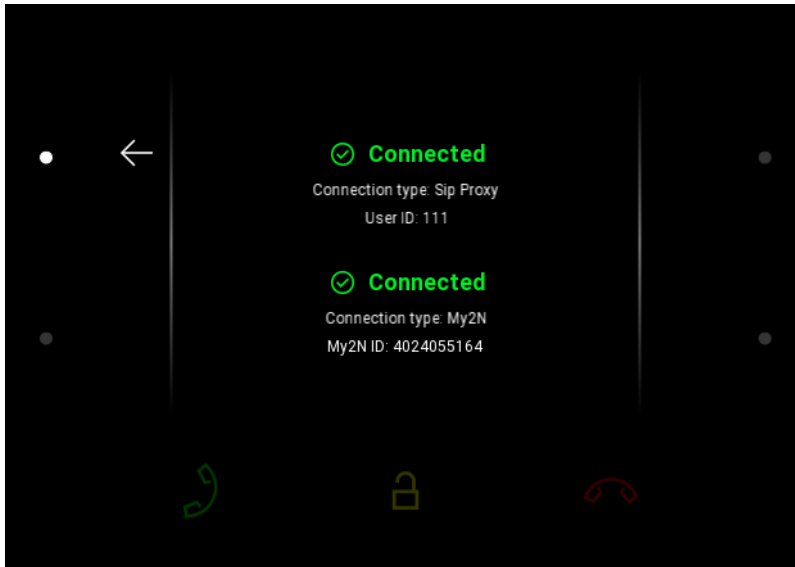

The My2N/SIP Proxy section displays the current state of the My2N/SIP Proxy connections.



## Language

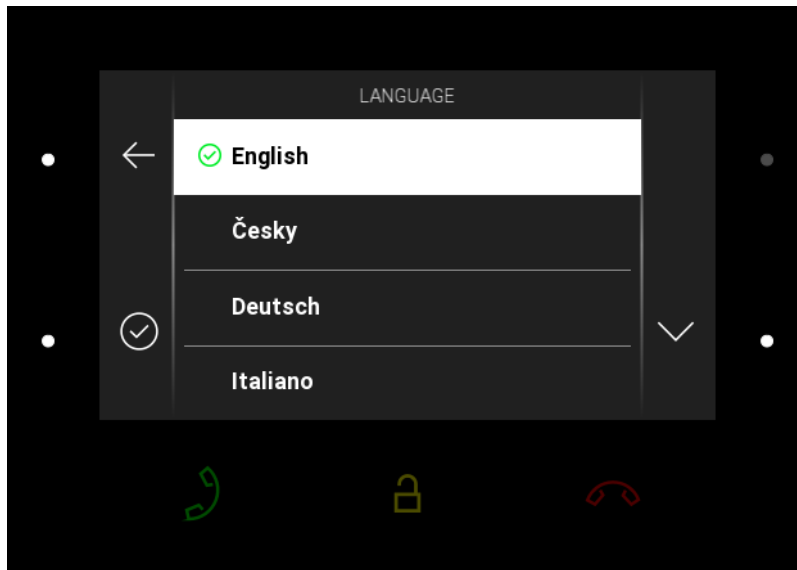

Press the right-hand upper/lower button to move up/down the language list. The change will not be saved unless confirmed.

## About Device

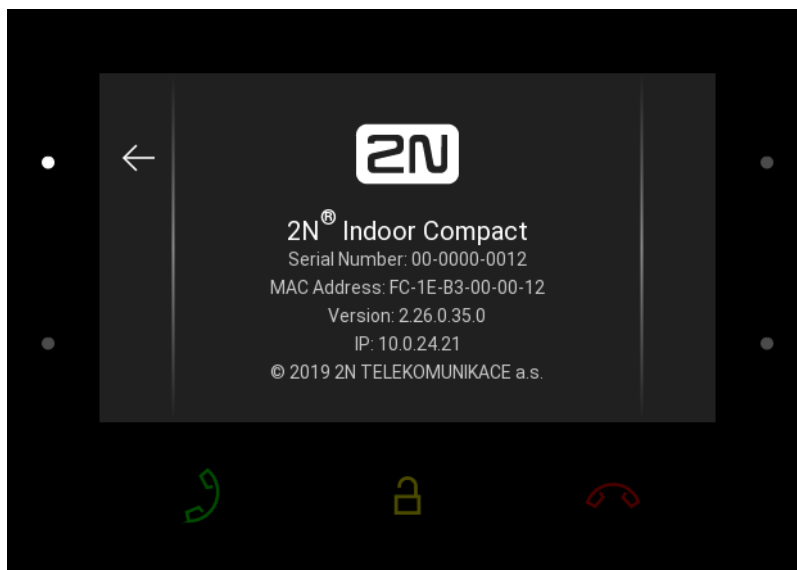





This section provides basic information on the device (serial number, MAC address, FW version, IP address).

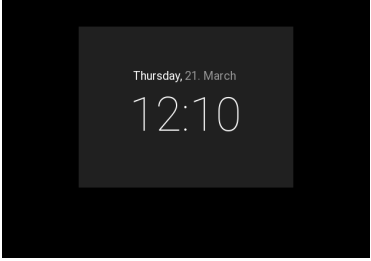

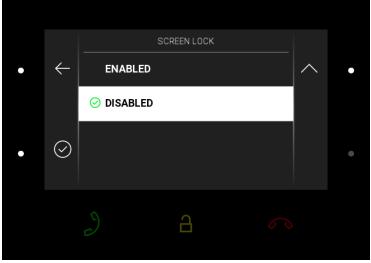
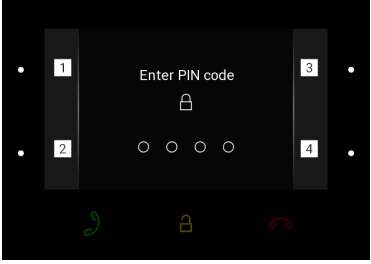

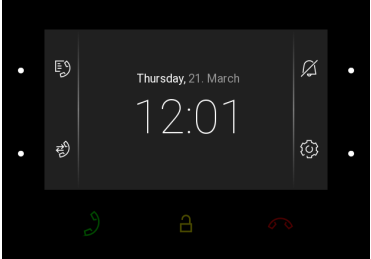
## 5. Operational Statuses



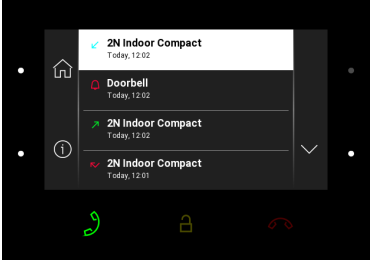

This section describes the user scenarios and states that may occur during operation, including the user options and expected results of actions.







| Status and Description   | User Actions   | Navigation       | Actions and Result                    |
|--|--|------------------|---------------------------------------|
| <p><b>Sleep Mode</b></p>  | <b>No button is backlit and time is displayed on the screen.</b> |                  |                                       |
|  | End relax mode   | Press any button | Home page/parental lock is displayed. |

| Status and Description  | User Actions  | Navigation                             | Actions and Result                              |
|---|---|--|---|
| <p><b>Parental Lock</b></p>   | <p><b>“Unlock device” and dial pad are displayed. The digit buttons and red earpiece are backlit to the maximum, the other buttons are ambiently backlit.</b></p> |  |   |
|   | Deactivate parental lock  | Correct PIN entering                   | The device is unlocked, Home page is displayed. |
|   | Enter invalid PIN   | PIN mistyping                          | The PIN code reentering command is displayed.   |
|   | Quit PIN code entering  | Press the red earpiece to end the call | The device gets in the sleep mode.              |

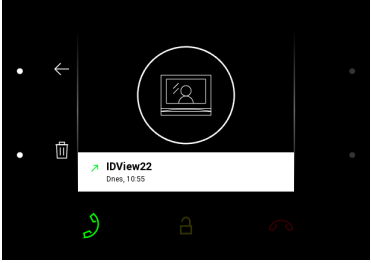
| Status and Description  | User Actions   | Navigation  | Actions and Result  |
|---|--|---|---|
| <b>Home Page</b><br> | <b>The device is at relax, the side buttons are backlit to the maximum, the other buttons are ambiently backlit.</b> |   |   |
|   | Display Directory  | Press the left-hand upper button at the  icon    | The list of all available devices is displayed.           |
|   | Display Call log   | Press the left-hand lower button at the  icon    | The list of all accomplished calls is displayed.          |
|   | Activate DND mode  | Press the right-hand upper button at the  icon | DND is activated and the activation message is displayed. |
|   | Display Settings   | Press the right-hand lower button at the  icon | The Settings section is displayed.                        |







| Status and Description   | User Actions  | Navigation   | Actions and Result  |
|--|---|--|---|
| <p><b>Call Log</b></p>  | <p><b>The device displays a list of all accomplished calls including date, time, status (outgoing/incoming/missed) and information on from/to which destination the call was made. The destinations that allow for some actions are white-highlighted; the other ones are gray. The side buttons and call receiving button are backlit to the maximum, the call end and lock buttons are ambiently backlit.</b></p> |  |   |
|  | <p>Show call detail</p>   | <p>Press the right-hand upper/lower button at the  and  icons to move up/down the call log; press the left-hand lower button to display the call detail.</p> | <p>The call detail is displayed.</p>  |
|  | <p>Outgoing call</p>  | <p>Press the call receiving button </p>   | <p>An outgoing call is set up for the white-highlighted device on the list.</p>   |
|  | <p>Door unlocking</p>   | <p>Press lock button </p>   | <p>A call is set up or not depending on the connection type and the door is unlocked. If automatic call end after unlocking is enabled, the call is ended after door unlocking.</p> |

| Status and Description | User Actions        | Navigation  | Actions and Result  |
|------------------------|---------------------|---|---|
|                        | Move down the list  | Press the right-hand lower button at the  icon   | The list goes by one item down; when the list end is reached, the movement stops and the arrow button goes off. |
|                        | Move up the list    | Press the right-hand upper button at the  icon   | The list goes by one item up; when the list top is reached, the movement stops and the arrow button goes off.   |
|                        | Return to Home page | Press the call end button   | Home page is displayed.   |
|                        | Bulk call deletion  | Press the right-hand upper button at the  icon and double click  for confirmation | All calls included in the call list are deleted.  |

| Status and Description  | User Actions  | Navigation  | Actions and Result  |
|---|---|---|---|
| <p><b>Call Log Detail</b></p>  | <p><b>The display shows a snapshot from the camera set in the 2N IP intercom if a camera-equipped device initiated the call. A device symbol is displayed if the call initiating device is not equipped with a camera. Furthermore, the call day, date and time, description of the calling/called device and call status (outgoing/incoming/missed) are displayed. The side buttons and call receiving button are backlit to the maximum, the other buttons are ambiently backlit.</b></p> |   |   |
|   | Return to Home page   | Press the call end button                       | The device returns to Home page.  |
|   | Return to call log  | Press the left-hand lower button at the  icon   | The device returns to the call log.   |
|   | Move down   | Press the right-hand lower button at the  icon | The list goes by one item down; when the list end is reached, the movement stops and the arrow button goes off. |
|   | Move up   | Press the right-hand upper button at the  icon | The list goes by one item up; when the list top is reached, the movement stops and the arrow button goes off.   |
|   | Outgoing call   | Press the call receiving button                | The device gets in the In call state.   |

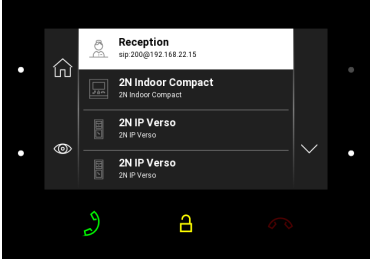



| Status and Description | User Actions   | Navigation  | Actions and Result   |
|------------------------|----------------|---|--|
|                        | Door unlocking | Press the lock button  | A call is set up or not depending on the connection type and the door is unlocked. If automatic call end after unlocking is enabled, the call is ended after door unlocking. |





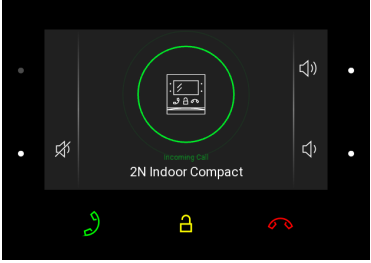



| Status and Description  | User Actions             | Navigation   | Actions and Result   |
|---|--------------------------|--|--|
|   | Log deletion             | Press the  button and  for confirmation | A record is deleted from the call log. After deletion, the device returns to the call log.   |
| <b>Directory</b><br> |                          |  | <p><b>The device displays a list of destinations that can be called. The destinations include their names and the device type they are equipped with. The destinations that allow for some actions (calls) are white-highlighted. The other destinations are gray. The left-hand side buttons and the call receiving button are backlit to the maximum. The lock button is backlit to the maximum in the 2N IP intercoms (LAN or My2N and/or Proxy devices with DTMF codes) but ambiently backlit in devices other than those mentioned above.</b></p> |
|   | Return to Home page      | Press the call end button   | Home page is displayed.  |
|   | Return to directory list | Press the left-hand upper button at the  icon   | The device returns to the directory list.  |
|   | Move down                | Press the right-hand lower button at the  icon  | The list goes by one item down; when the list end is reached, the movement stops and the arrow button goes off.  |
|   | Move up                  | Press the right-hand upper button at the  icon  | The list goes by one item up; when the list top is reached, the movement stops and the arrow button goes off.  |

| Status and Description | User Actions  | Navigation   | Actions and Result                   |
|------------------------|---------------|--|--------------------------------------|
|                        | Outgoing call | Press the call receiving button<br> | The device gets in the In call mode. |



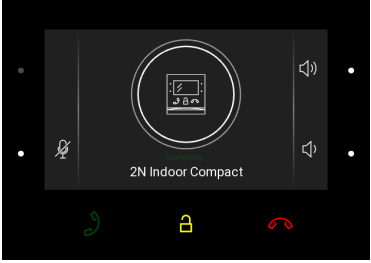

| Status and Description | User Actions   | Navigation  | Actions and Result   |
|------------------------|----------------|---|--|
|                        | Door unlocking | Press the lock button  | A call is set up or not depending on the connection type and the door is unlocked. If automatic call end after unlocking is enabled, the call is ended after door unlocking. |

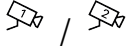
| Status and Description  | User Actions   | Navigation  | Actions and Result  |
|---|--|---|---|
| <p><b>Incoming Call</b></p>  | <p><b>The device is playing the selected ringtone. The display shows the camera view if available, CLIP and Incoming call message. The call receiving, lock and call end buttons are backlit to the maximum. The left-hand lower button at the Mute icon and the ringing volume up/down buttons to the right are backlit to the maximum.</b></p> |   |   |
|   | <p>Pick up call</p>  | <p>Press the call receiving button<br/> </p> | <p>The connection is established and the In call mode is switched on.</p>   |
|   | <p>Reject call</p>   | <p>Press the call end button<br/> </p>      | <p>The incoming call is discontinued and Home page is returned to.</p>  |
|   | <p>Door unlocking</p>  | <p>Press the lock button<br/> </p>         | <p>A call is set up or not depending on the connection type and the door is unlocked. If automatic call end after unlocking is enabled, the call is ended after door unlocking.</p> |



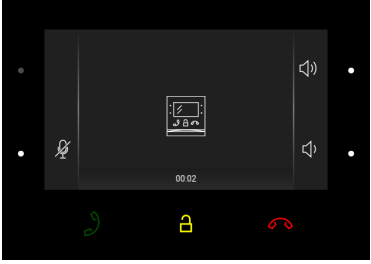

| Status and Description | User Actions   | Navigation  | Actions and Result  |
|------------------------|--|---|---|
|                        | <p>The camera is switched (if installed and configured in the 2N IP intercom).</p> | <p>Press the left-hand upper button with the camera icon at  / </p> | <p>The display shows the view from camera 2, called device and Incoming call message. The call receiving, lock and call end buttons are backlit to the maximum. The left-hand lower button at the Mute icon and the ringing volume up/down buttons to the right are backlit to the maximum. The camera 1 switching button is shining, camera switch is performed.</p> |
|                        | <p>Ringing volume up</p>   | <p>Press the right-hand upper button at the  icon</p>  | <p>The ringtone volume is increased by 1 step by each press. When the scale top is reached, the button goes off. The volume level is automatically written to the settings.</p>   |
|                        | <p>Ringing volume down</p>   | <p>Press the right-hand lower button at the  icon</p>  | <p>The ringtone volume is decreased by 1 step by each press. When the scale end is reached, the button goes off. The volume level is automatically written to the settings.</p>   |

| Status and Description  | User Actions   | Navigation   | Actions and Result  |
|---|--|--|---|
| <p><b>Outgoing Call</b></p>  | <p><b>The device is playing the ringtone. The display shows the camera view if available, called device ID and Outgoing call message. The lock and call end buttons are backlit to the maximum, the call receiving button is ambiently backlit. The left-hand lower button at the Mute icon is backlit to the maximum. The ringing volume up/down buttons to the right are backlit to the maximum. A beep signals that the highest/lowest level has been achieved, the appropriate button is ambiently backlit. The camera 2 (if available) switching button is backlit to the maximum. If camera 2 is unavailable, the button is ambiently backlit and the icon is not displayed.</b></p> |  |   |
|   | <p>End call</p>  | <p>Press the call end button </p>          | <p>The outgoing call is discontinued and Home page is returned to.</p>  |
|   | <p>Unlock door</p>   | <p>Press the lock button </p>             | <p>A call is set up or not depending on the connection type and the door is unlocked. If automatic call end after unlocking is enabled, the call is ended after door unlocking.</p>   |
|   | <p>Switch camera</p>   | <p>Press the left-hand upper button </p> | <p>The display shows the view from camera 2, called device and Incoming call message. The call receiving, lock and call end buttons are backlit to the maximum. The camera 1 switching button is lit, camera switch is performed.</p> |





| Status and Description | User Actions | Navigation  | Actions and Result  |
|------------------------|--------------|---|---|
|                        | Reject call  | The call is rejected by the called device, not the <b>2N® Indoor Compact</b> user.                                  | The display shows Call rejected, the call is terminated and Home page is returned to. |
|                        | Mute call    | Press the Mute button at the  icon | The call is muted.  |



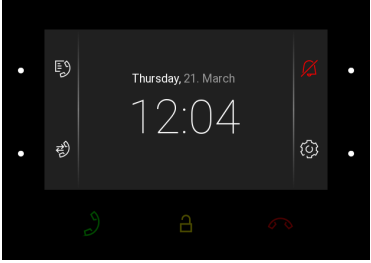

| Status and Description  | User Actions  | Navigation   | Actions and Result  |
|---|---|--|---|
| <p><b>In Call</b></p>  | <p><b>The display shows the camera view if available, or the called device ID if no camera is available. A timer is running at the view. The call receiving button is ambiently backlit. The lock and call end buttons are backlit to the maximum. The left-hand lower button at the Mute icon and the ringing volume up/down buttons are backlit to the maximum. The camera 2 (if available) switching button is backlit to the maximum. If the second camera is unavailable, the button is not backlit and the icon is not displayed.</b></p> |  |   |
|   | <p>Mute call</p>  | <p>Press the Mute button at the  icon</p> | <p>The device is in the In call mode but sound is not transferred to the calling device. The Mute icon turns red. "No one hears you" message is displayed.</p>                      |
|   | <p>End call</p>   | <p>Press the call end button </p>      | <p>The outgoing call is discontinued and Home page is returned to.</p>  |
|   | <p>Unlock door</p>  | <p>Press the lock button </p>           | <p>A call is set up or not depending on the connection type and the door is unlocked. If automatic call end after unlocking is enabled, the call is ended after door unlocking.</p> |



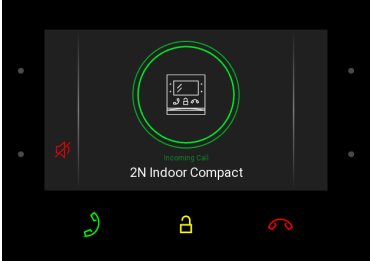

| Status and Description | User Actions        | Navigation   | Actions and Result   |
|------------------------|---------------------|--|--|
|                        | Switch camera       | Press the left-hand upper button  /  | The display shows the camera 2 view, called device ID and timer. The call receiving, lock and call end buttons are backlit to the maximum. The left-hand lower button at the Mute icon and the ringing volume up/down buttons to the right are backlit to the maximum. The camera 1 switching button is lit, camera switch is performed. |
|                        | Ringing volume up   | Press the right-hand upper button at the  icon  | The ringtone volume is increased by 1 step by each press. When the scale top is reached, the button goes off. The volume level is automatically written to the settings.   |
|                        | Ringing volume down | Press the right-hand lower button at the  icon  | The ringtone volume is decreased by 1 step by each press. When the scale end is reached, the button goes off. The volume level is automatically written to the settings.   |





| Status and Description | User Actions       | Navigation  | Actions and Result   |
|------------------------|--------------------|---|--|
|                        | Cancel call muting | Press the left-hand lower button with the mute icon  | The device is in the In call mode and sound is transmitted again to the calling device. The mute icon turns white. |

| Status and Description   | User Actions  | Navigation  | Actions and Result                                 |
|--|---|---|--|
| <p><b>DND Mode</b></p>  | <p><b>The device is at relax, the side buttons are backlit to the maximum, the other buttons are off. The doorbell icon is red.</b></p> |   |  |
|  | Display Directory   | Press the left-hand upper button at the  icon    | The list of all available devices is displayed.    |
|  | Display Call log  | Press the left-hand lower button at the  icon    | The list of all accomplished calls is displayed.   |
|  | Disable DND mode  | Press the right-hand upper button at the  icon | DND is deactivated, the doorbell icon turns white. |
|  | Display Settings  | Press the right-hand lower button at the  icon | The Settings section is displayed.                 |

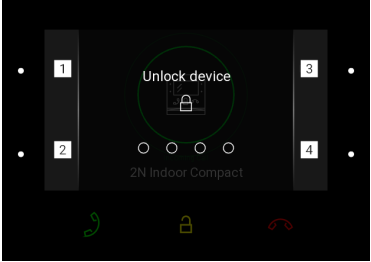
| Status and Description  | User Actions   | Navigation  | Actions and Result   |
|---|--|---|--|
| <p><b>Incoming Call in DND Mode</b></p>  | <p><b>The device does not play the selected ringtone. The display shows the camera view if available, CLIP and Incoming call message. The call receiving, lock and call end buttons are backlit to the maximum. The left-hand lower button at the Mute icon and the ringing volume up/down buttons to the right are backlit to the maximum. The camera 2 (if available) switching button is backlit to the maximum. If camera 2 is unavailable, the button is not backlit and the icon is not displayed.</b></p> |   |  |
|   | <p>Pick up call</p>  | <p>Press the call receiving button<br/> </p>   | <p>The call is connected. The device is in the In call mode.</p>   |
|   | <p>Reject call</p>   | <p>Press the call end button<br/> </p>   | <p>The incoming call is discontinued and Home page is returned to.</p>   |
|   | <p>Switch camera</p>   | <p>Press the left-hand upper button at the<br/>  /<br/>  icon</p> | <p>The display shows the view from camera 2, called device ID and Incoming call message. The call receiving, lock and call end buttons are backlit to the maximum. The left-hand lower button at the Mute icon and the ringing volume up/down buttons to the right are backlit to the maximum. The camera 1 switching button is lit, camera switch is performed.</p> |

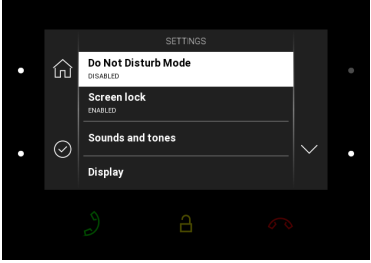
| Status and Description | User Actions        | Navigation  | Actions and Result   |
|------------------------|---------------------|---|--|
|                        | Ringing volume up   | Press the right-hand upper button at the  icon | The volume starts increasing from the lowest possible level. The ringtone volume is increased by 1 step by each press. When the scale top is reached, the button goes off. This action does not affect the ringing level when DND is off.                  |
|                        | Ringing volume down | Press the right-hand lower button at the  icon | The volume cannot start decreasing until the maximum volume level is reached. The ringtone volume is decreased by 1 step by each press. When the scale end is reached, the button goes off. This action does not affect the ringing level when DND is off. |

| Status and Description  | User Actions | Navigation | Actions and Result   |
|---|--------------|------------|--|
| <p><b>Incoming Call with Parental Lock On</b></p>  |              |            | <p>The device is playing the selected ringtone. The display shows the camera view if available, CLIP and Incoming call message. The call receiving, lock and call end buttons are backlit to the maximum. The left-hand lower button at the Mute icon and the ringing volume up/down buttons to the right are backlit to the maximum. Press any button to display the parental lock deactivation command. The call view is displayed on the background, the call end button is backlit to the maximum, the incoming call with parental lock on state is recovered (parental lock deactivation command and dial pad disappear).</p> |

| Status and Description   | User Actions      | Navigation  | Actions and Result |
|--|-------------------|---|--------------------|
| <p><b>Settings</b></p>  | Go one level back | Press the left-hand upper button at the  icon    |                    |
|  | Confirm selection | Press the left-hand lower button at the  icon    |                    |
|  | Move up           | Press the right-hand upper button at the  icon   |                    |
|  | Move down         | Press the right-hand lower button at the  icon |                    |

## 6. Maintenance – Cleaning

If used frequently, the device surface gets dirty. Use a piece of soft cloth moistened with clean water to clean the device.

**You are recommended to follow the principles below while cleaning:**

Do not use aggressive detergents (such as abrasives or strong disinfectants). Use appropriate cleaning agents suitable for glasses, optical devices, screens, etc. Alcohol-based cleaners may not be applied. We recommend you to use IT cleaning wipes.



## 7. Technical Parameters

### Power Supply

- **Type:** 12 V DC +/-10 % adapter or PoE 802.3af
- **Recommended power supply:** 12 V / 1 A
- **Polarity reversal protection:** yes

### Power Consumption

- **In idle:**
  - **12 V:** 1,2 W – 0,1 A
  - **PoE:** 1,9 W
- **Max. in active state:** 12 W / 1 A

### User Interface

- **Control:** 7 capacitive buttons with white and RGB LED backlight
- **Display:** 4.3'' with 480 x 272 pixel resolution
- **Service:** RESET button with long press option for factory reset, 3 status LEDs

### Signalling protocol

- **SIP (UDP, TCP, TLS)**

### Audio

- **Microphone:** integrated
- **Speaker:** 2 W integrated
- **Induction loop output:** 600 mV RMS

### Audio stream

- **Protocols:** RTP / RTSP
- **Codecs:** G.711, G.729, G.722, L16/16 kHz

### Video stream

- **Protocols:** RTP / RTSP / HTTP, M-JPEG
- **Codecs:** H.264, M-JPEG

### Interface

- **LAN:** 10/100BaseT, RJ-45; Cat5e or higher

### Doorbell Input

- **Input type:** switching contact (button/relay)
- **Contact type:** normally open (NO)
- **Contact parameters:** up to 50 V / 5 mA, DC

### Mechanical Parameters

- **Dimensions (w x h x d):** 152 x 153 x 50 mm
- **Weight:** 387 g

- **Operating temperature:** 0 to 50 °C
- **Relative humidity:** 10 to 90 % non-condensing
- **Storing temperature:** -20 to 70 °C
- **Recommended altitude:** 0–2000 m

## 8. Supplementary Information

This section provides supplementary information on the **2N® Indoor Compact** product.

Here is what you can find in this section:

- [8.1 Troubleshooting](#)
- [8.2 Directives, Laws and Regulations - General Instructions and Cautions](#)

### 8.1 Troubleshooting



For the most frequently asked questions refer to [faq.2n.cz](http://faq.2n.cz).

### 8.2 Directives, Laws and Regulations - General Instructions and Cautions

**2N® Indoor Compact** conforms to the following directives and regulations:

- 2014/35/EU for electrical equipment designed for use within certain voltage limits
- 2014/30/EU for electromagnetic compatibility
- 2011/65/EU on the restriction of the use of certain hazardous substances in electrical and electronic equipment
- 2012/19/EU on waste electrical and electronic equipment

#### Industry Canada

This Class B digital apparatus complies with Canadian ICES-003/NMB-003.

#### FCC

This equipment has been tested and found to comply with the limits for a Class B digital device, pursuant to part 15 of the FCC Rules.

NOTE: These limits are designed to provide reasonable protection against harmful interference in a residential installation. This equipment generates, uses and can radiate radio frequency energy and, if not installed and used in accordance with the instructions, may cause harmful interference to radio communications.

However, there is no guarantee that interference will not occur in a particular installation. If this equipment does cause harmful interference to radio or television reception, which can be determined by turning the equipment off and on, the user is encouraged to try to correct the interference by one or more of the following measures:

- Reorient or relocate the receiving antenna
- Increase the separation between the equipment and receiver
- Connect the equipment into an outlet on a circuit different from that to which the receiver is connected

- Consult the dealer or an experienced radio/TV technician for help

Changes or modifications to this unit not expressly approved by the party responsible for compliance could void the user's authority to operate this equipment.

**⚠ Caution**

**Warning**

In order to ensure the full functionality and guaranteed performance, we strongly recommend that the topicality of the product / device version in use be verified as early as in the installation process. The customer hereby acknowledges that the product / device can achieve the guaranteed performance and full functionality pursuant to the manufacturer's instructions only if the latest product / device version is used after having been tested for full interoperability and not having been determined by the manufacturer as incompatible with certain versions of other products, and only in conformity with the manufacturer's instructions, guidelines or recommendations and in conjunction with suitable products and devices of other suppliers. The latest versions are available at [https://www.2n.com/cs\\_CZ/](https://www.2n.com/cs_CZ/) or can be updated via the configuration interface if the devices are adequately technically equipped. Should the customer use a product / device version other than the latest one or a version determined by the manufacturer as incompatible with certain versions of other products, or should the customer use the product / device in contradiction to the manufacturer's instructions, guidelines or recommendations or in conjunction with unsuitable products / devices of other suppliers, the customer is aware of and agrees with all functionality limitations of such a product / device if any as well as with all consequences incurred as a result thereof. Using a product / device version other than the latest one or a version determined by the manufacturer as incompatible with certain versions of other products, or using the product / device in contradiction to the manufacturer's instructions, guidelines or recommendations or in conjunction with unsuitable products / devices of other suppliers, the customer agrees that the 2N TELEKOMUNIKACE a.s. company shall not be held liable for any functionality limitation of such a product or any damage, loss or injury related to this potential functionality limitation.

Please read this User Manual carefully before using the product. Follow all instructions and recommendations included herein.

Any use of the product that is in contradiction with the instructions provided herein may result in malfunction, damage or destruction of the product.

The manufacturer shall not be liable and responsible for any damage incurred as a result of a use of the product other than that included herein, namely undue application and disobedience of the recommendations and warnings in contradiction herewith.

Any use or connection of the product other than those included herein shall be considered undue and the manufacturer shall not be liable for any consequences arisen as a result of such misconduct.

Moreover, the manufacturer shall not be liable for any damage or destruction of the product incurred as a result of misplacement, incompetent installation and/or undue operation and use of the product in contradiction herewith.

The manufacturer assumes no responsibility for any malfunction, damage or destruction of the product caused by incompetent replacement of parts or due to the use of reproduction parts or components.

The manufacturer shall not be liable and responsible for any loss or damage incurred as a result of a natural disaster or any other unfavourable natural condition.

The manufacturer shall not be held liable for any damage of the product arising during the shipping thereof.

The manufacturer shall not make any warrant with regard to data loss or damage.

The manufacturer shall not be liable and responsible for any direct or indirect damage incurred as a result of a use of the product in contradiction herewith or a failure of the product due to a use in contradiction herewith.

All applicable legal regulations concerning the product installation and use as well as provisions of technical standards on electric installations have to be obeyed. The manufacturer shall not be liable and responsible for damage or destruction of the product or damage incurred by the consumer in case the product is used and handled contrary to the said regulations and provisions.

The consumer shall, at its own expense, obtain software protection of the product. The manufacturer shall not be held liable and responsible for any damage incurred as a result of the use of deficient or substandard security software.

The consumer shall, without delay, change the access password for the product after installation. The manufacturer shall not be held liable or responsible for any damage incurred by the consumer in connection with the use of the original password.

The manufacturer also assumes no responsibility for additional costs incurred by the consumer as a result of making calls using a line with an increased tariff.

### Electric Waste and Used Battery Pack Handling



Do not place used electric devices and battery packs into municipal waste containers. An undue disposal thereof might impair the environment!

Deliver your expired electric appliances and battery packs removed from them to dedicated dumpsites or containers or give them back to the dealer or manufacturer for environmental-friendly disposal. The dealer or manufacturer shall take the product back free of charge and without requiring another purchase. Make sure that the devices to be disposed of are complete.

Do not throw battery packs into fire. Battery packs may not be taken into parts or short-circuited either.

